Introduction to Resource-Oriented Applications in Constrained Networks

Zach Shelby

Smart Objects Tutorial, IETF-80 Prague

Tutorial Overview

- Powering M2M with a Web of Things
 - So What are Web Services?
 - CoRE - Constrained RESTful Environments
 - Constrained Application Protocol Basics
 - Observation
 - Block-transfer
 - Discovery
 - Semantic Soup
 - Further Information
-

The Web of Things

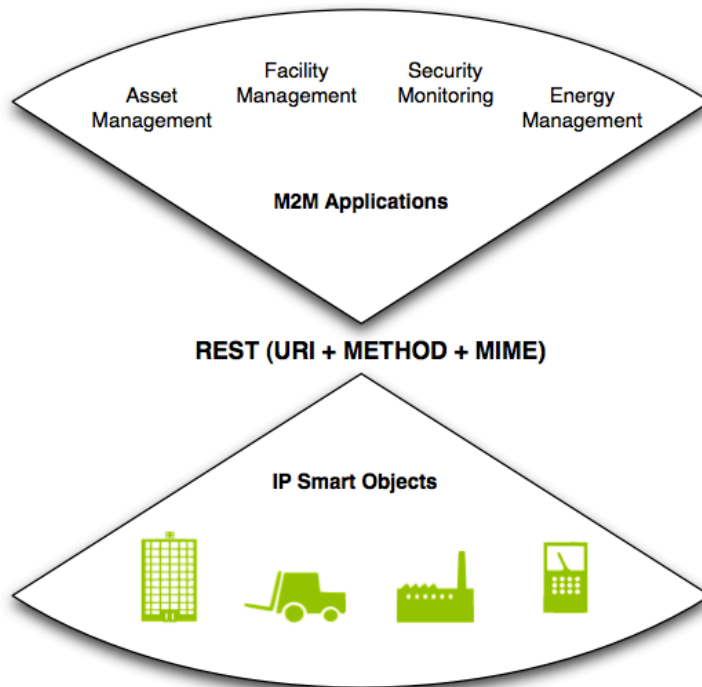

What are Web Services?

The Web Architecture

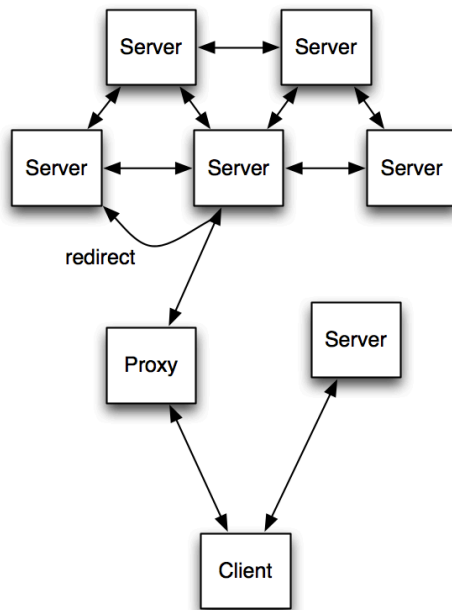

Web Resource Identification

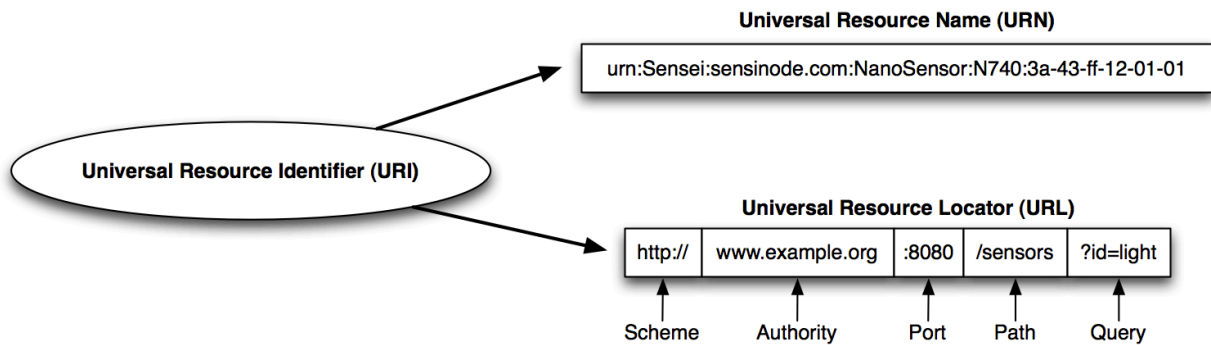

The Web Service Paradigm

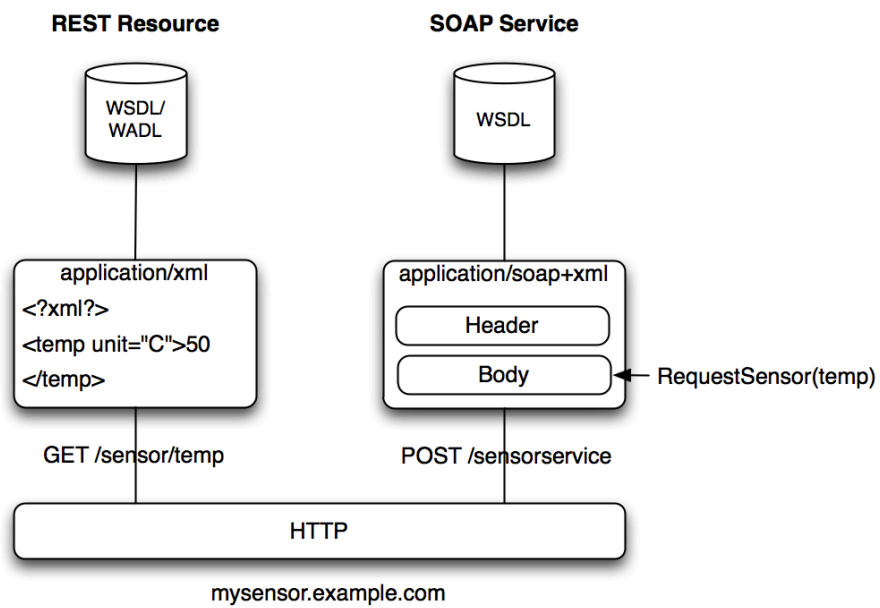

A REST Request

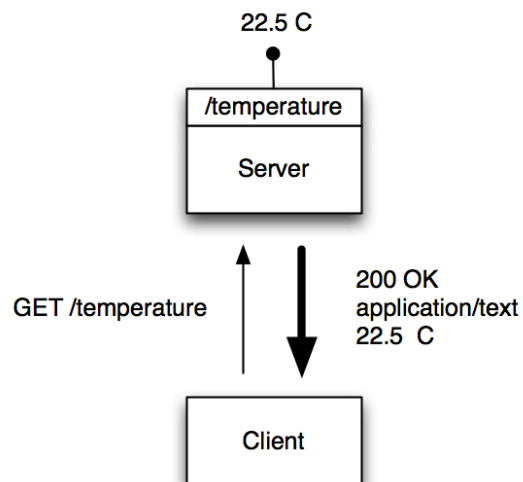

An HTTP Request

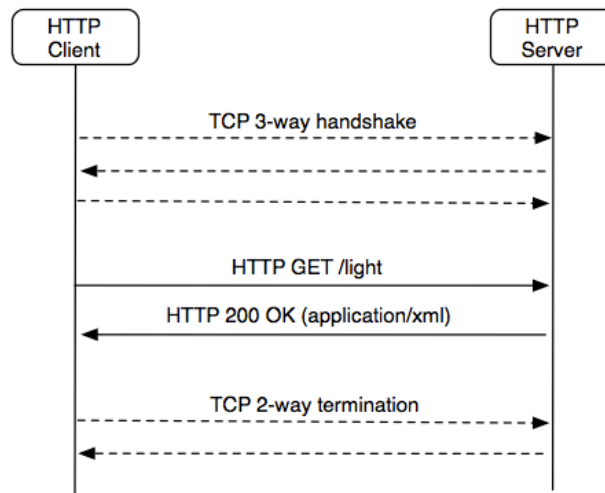

See RFC2616 - Hypertext Transfer Protocol v1.1

CoRE - Constrained RESTful
Environments

CoRE Requirements

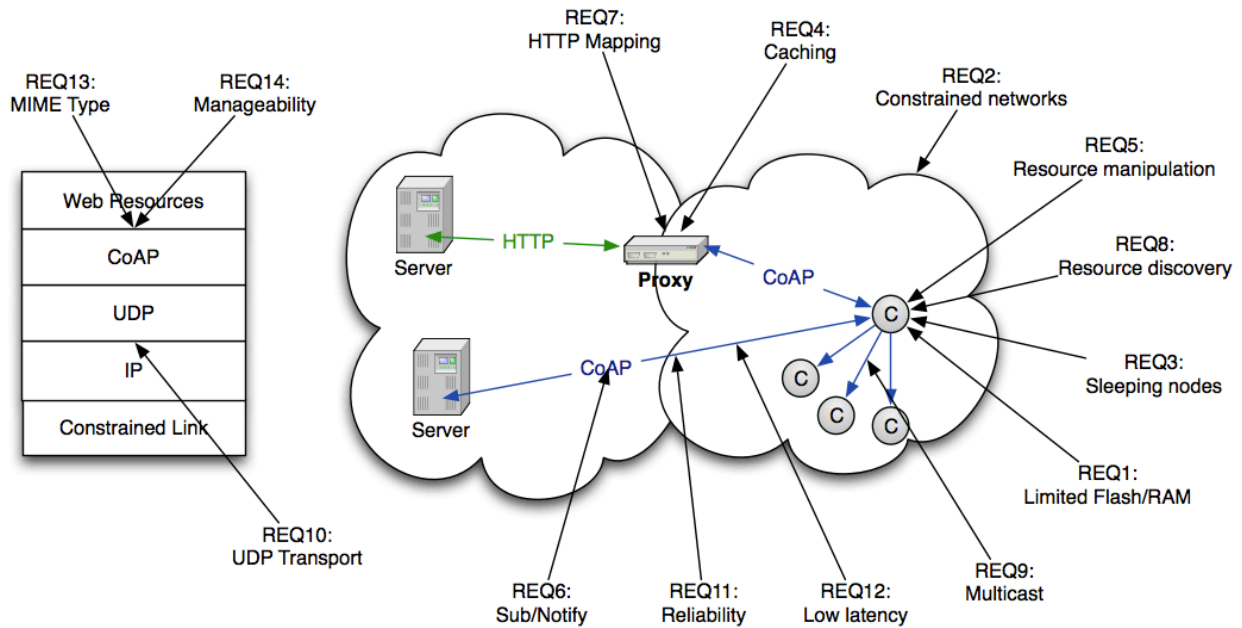

See draft-shelby-core-coap-req

The CoRE Architecture

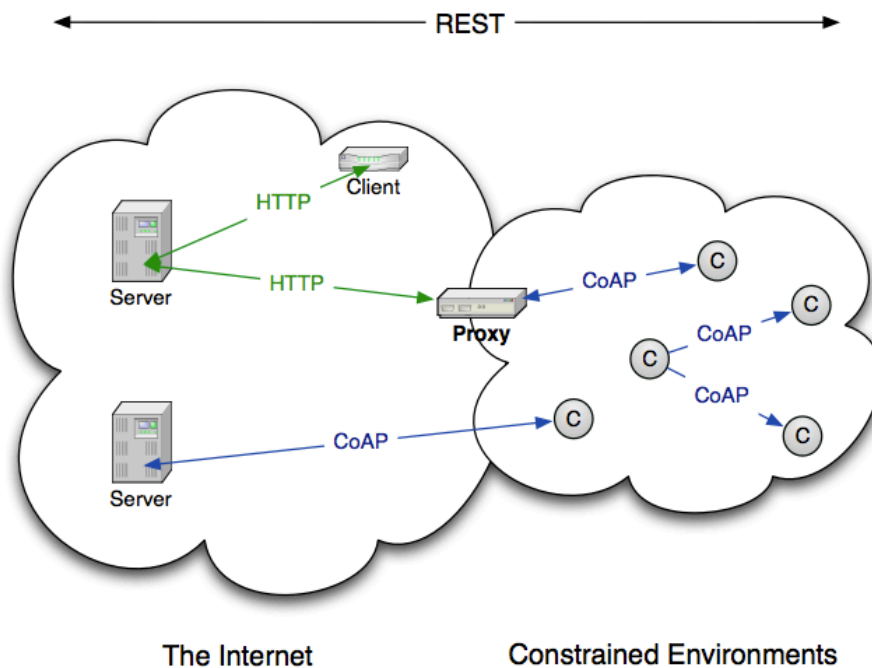

The Constrained Application Protocol

- Embedded web transfer protocol (coap://)
 - Asynchronous transaction model
 - UDP binding with reliability and multicast support
 - GET, POST, PUT, DELETE methods
 - URI support
 - Small, simple header < 10 bytes
 - Subset of MIME types and HTTP-compatible response codes
 - Optional observation, block transfer and discovery
-
-

What CoAP is (and is not)

- CoAP is
 - A RESTful protocol
 - Both synchronous and asynchronous
 - For constrained devices and networks
 - Specialized for M2M applications
 - Easy to proxy to/from HTTP
 - CoAP is not
 - A replacement for HTTP
 - General HTTP compression
 - Separate from the web
-

The Transaction Model

- Transport
 - CoAP is defined for UDP
- Messaging
 - Simple message exchange between end-points
 - CON, NON, ACK, RST
- REST
 - Request/Response piggybacked on messages
 - Method, Response Code and Options (URI, content-type etc.)

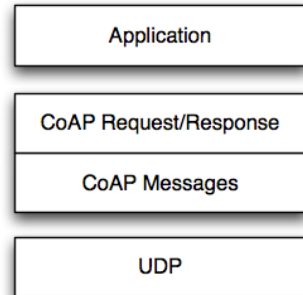

Message Header

```
0           1           2           3
0 1 2 3 4 5 6 7 8 9 0 1 2 3 4 5 6 7 8 9 0 1 2 3 4 5 6 7 8 9 0 1
+--+--+--+--+--+--+--+--+--+--+--+--+--+--+--+--+--+--+--+--+--+
|Ver| T |  OC  |      Code      |      Message ID      |
+--+--+--+--+--+--+--+--+--+--+--+--+--+--+--+--+--+--+--+--+--+
|  Options (if any) ...  |
+--+--+--+--+--+--+--+--+--+--+--+--+--+--+--+--+--+--+--+--+--+
|  Payload (if any) ...  |
+--+--+--+--+--+--+--+--+--+--+--+--+--+--+--+--+--+--+--+--+--+
```

Ver - Version (1)

T - Transaction Type (Confirmable, Non-Confirmable, Acknowledgement, Reset)

OC - Option Count, number of options after this header

Code - Request Method (1-10) or Response Code (40-255)

Message ID - Identifier for matching responses

Option Header

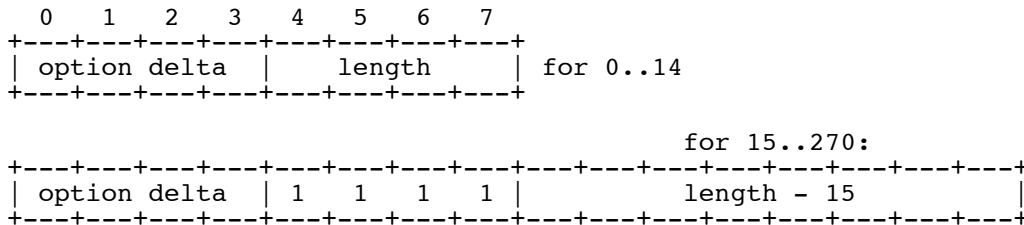

Option Delta - Difference between this option type and the previous

Length - Length of the option value (0-270)

Value - The value of Length bytes immediately follows Length

Options

No.	C/E	Name	Format	Length	Default
1	Critical	Content-Type	uint	1-2 B	0
2	Elective	Max-Age	uint	0-4 B	60
3	Critical	Proxy-Uri	string	1-270 B	(none)
4	Elective	ETag	opaque	1-8 B	(none)
5	Critical	Uri-Host	string	1-270 B	(see below)
6	Elective	Location-Path	string	1-270 B	(none)
7	Critical	Uri-Port	uint	0-2 B	(see below)
8	Elective	Location-Query	string	1-270 B	(none)
9	Critical	Uri-Path	string	1-270 B	(none)
11	Critical	Token	opaque	1-8 B	(empty)
15	Critical	Uri-Query	string	1-270 B	(none)

Request Examples

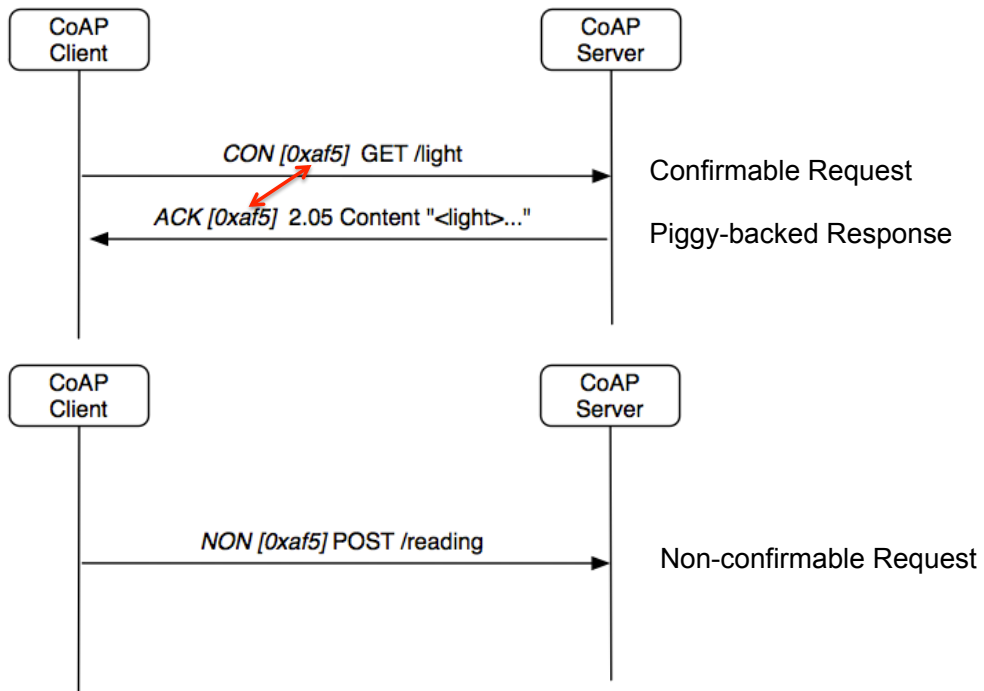

Dealing with Packet Loss

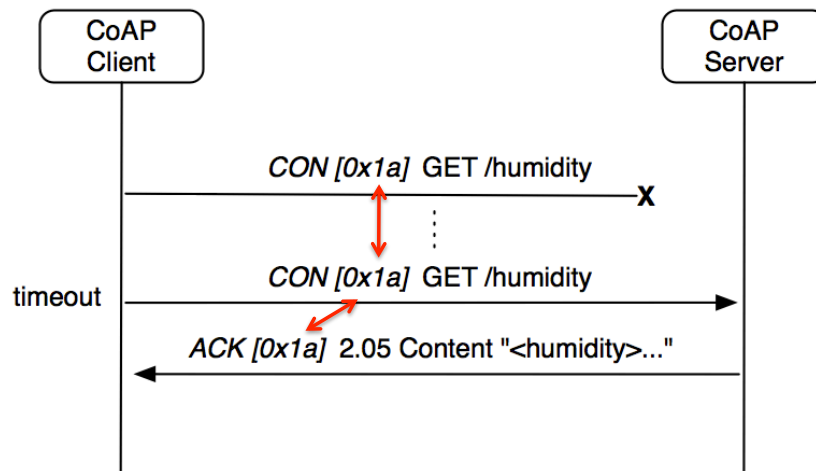

Caching

- CoAP includes a simple caching model
 - Cacheability determined by response code
- Freshness model
 - Max-Age option indicates cache lifetime
- Validation model
 - Validity checked using the Etag Option
- A proxy often supports caching
 - Usually on behalf of a sleeping node,
 - and to reduce network load

Proxying and caching

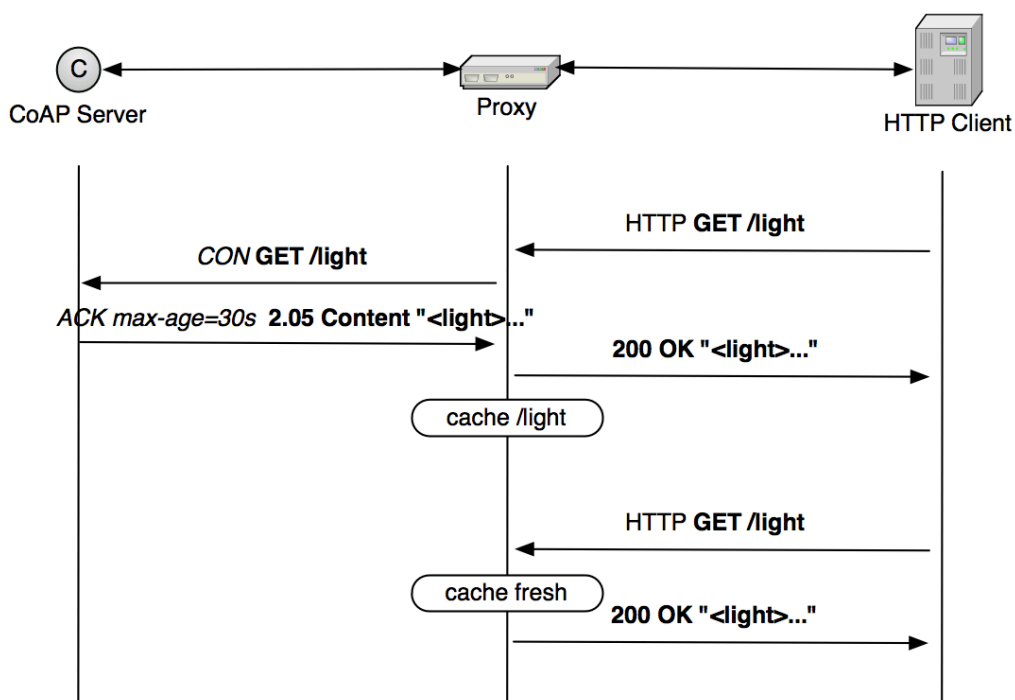

Observation

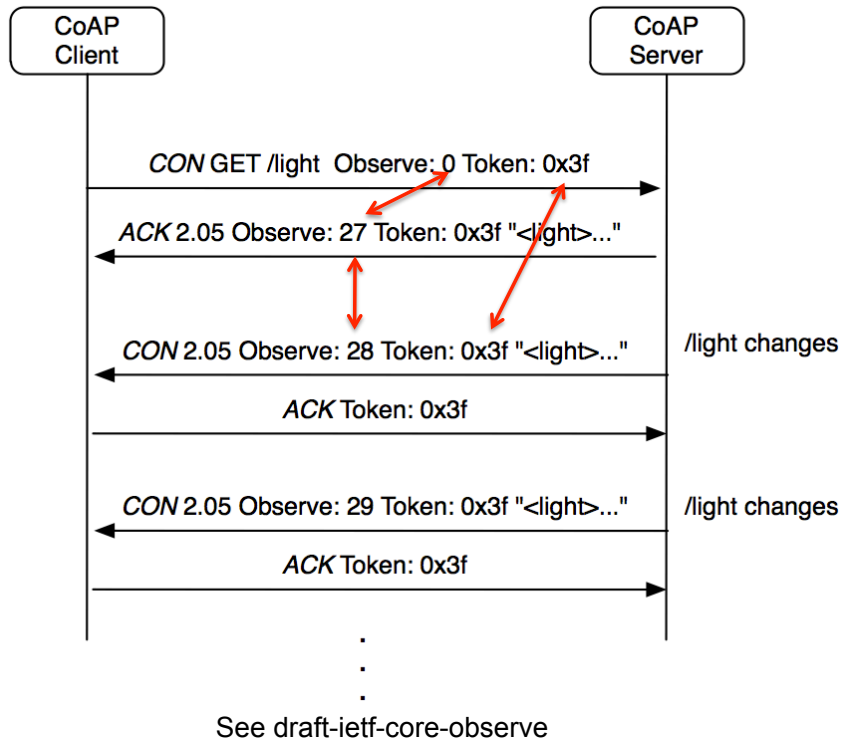

Block transfer

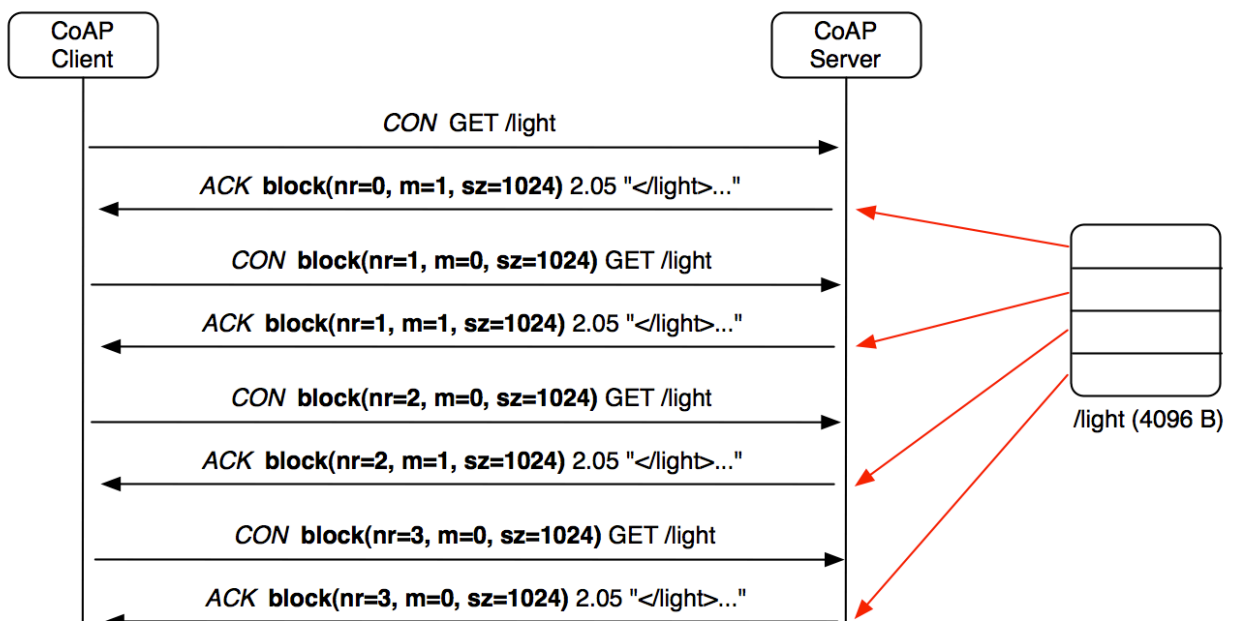

See draft-ietf-core-block

Resource Discovery

- Service Discovery
 - Leave this to e.g. DNS-SD
- Resource Discovery with CoRE Link Format
 - Web linking as per RFC5988
 - Discovering the links hosted by CoAP servers
 - GET /.well-known/core
 - Returns a link-header style format
 - URL, relation, type, interface, content-type etc.
- See *draft-ietf-core-link-format*

Resource Discovery

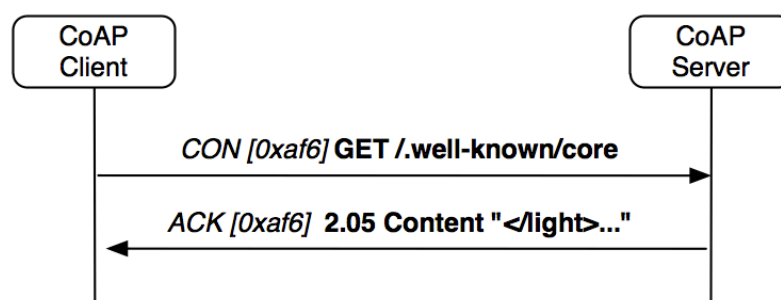

```
</light>;rt="Illuminance";ct=0,  
</s/maastr.xml>;title="Maastricht weather";ct=1,  
</s/maastr/temp>;title="Temperature in Maastricht";ct=1,  
</s/oulu.xml>;title="Oulu weather";ct=1,  
</s/oulu/temp>;title="Temperature in Oulu";ct=1,  
</s/temp>;rt="Temperature";ct=0
```

Semantic Soup

- So how to use CoRE in real applications?
 - Resources need meaningful naming (rt=)
 - A resource needs an interface (if=)
 - See draft-vial-core-link-format-wadl
 - A payload needs a format (EXI, JSON etc.)
 - Deployment or industry specific today
 - oBIX, SensorML, EEML, sMAP etc.
 - What can we make universal?
 - What should be market specific?
 - How do we enable innovation?
-

Further Information

- Z. Shelby “Embedded Web Services”, IEEE Wireless Communications, Dec 2010.
 - draft-ietf-core-coap
 - draft-ietf-core-block
 - draft-ietf-core-observe
 - draft-ietf-core-link-format
 - RFC5988 – Web Linking
 - Ongoing work in the CoRE WG
 - Security bootstrapping, resource directory, group communications, congestion control etc.
-