



Full wwPDB X-ray Structure Validation Report ⓘ

Jan 4, 2024 – 12:07 AM EST

PDB ID : 8U2M
Title : Structure of P450Blt from *Micromonospora* sp. MW-13 in Complex with Biarylitiide
Authors : Hansen, M.H.; Cryle, M.J.
Deposited on : 2023-09-06
Resolution : 1.79 Å(reported)

This is a Full wwPDB X-ray Structure Validation Report for a publicly released PDB entry.

We welcome your comments at validation@mail.wwpdb.org

A user guide is available at

<https://www.wwpdb.org/validation/2017/XrayValidationReportHelp>

with specific help available everywhere you see the ⓘ symbol.

The types of validation reports are described at

<http://www.wwpdb.org/validation/2017/FAQs#types>.

The following versions of software and data (see [references ⓘ](#)) were used in the production of this report:

MolProbity : 4.02b-467
Mogul : 1.8.5 (274361), CSD as541be (2020)
Xtrriage (Phenix) : 1.13
EDS : 2.36
buster-report : 1.1.7 (2018)
Percentile statistics : 20191225.v01 (using entries in the PDB archive December 25th 2019)
Refmac : 5.8.0158
CCP4 : 7.0.044 (Gargrove)
Ideal geometry (proteins) : Engh & Huber (2001)
Ideal geometry (DNA, RNA) : Parkinson et al. (1996)
Validation Pipeline (wwPDB-VP) : 2.36

1 Overall quality at a glance i

The following experimental techniques were used to determine the structure:

X-RAY DIFFRACTION

The reported resolution of this entry is 1.79 Å.

Percentile scores (ranging between 0-100) for global validation metrics of the entry are shown in the following graphic. The table shows the number of entries on which the scores are based.

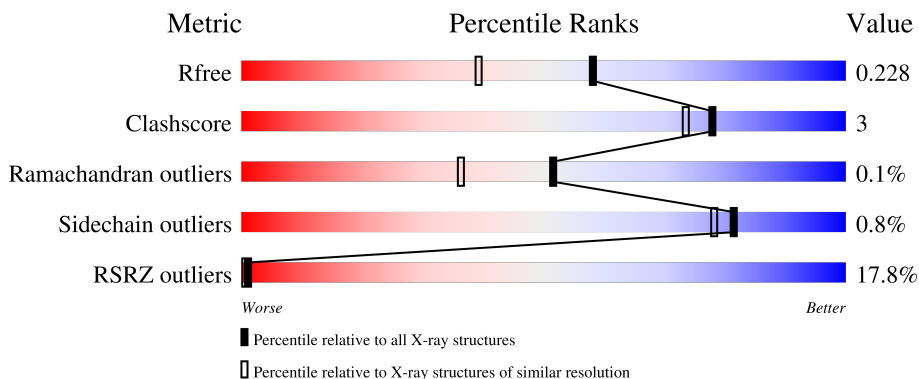

Metric	Whole archive (#Entries)	Similar resolution (#Entries, resolution range(Å))
R_{free}	130704	5950 (1.80-1.80)
Clashscore	141614	6793 (1.80-1.80)
Ramachandran outliers	138981	6697 (1.80-1.80)
Sidechain outliers	138945	6696 (1.80-1.80)
RSRZ outliers	127900	5850 (1.80-1.80)

The table below summarises the geometric issues observed across the polymeric chains and their fit to the electron density. The red, orange, yellow and green segments of the lower bar indicate the fraction of residues that contain outliers for ≥ 3 , 2, 1 and 0 types of geometric quality criteria respectively. A grey segment represents the fraction of residues that are not modelled. The numeric value for each fraction is indicated below the corresponding segment, with a dot representing fractions $\leq 5\%$. The upper red bar (where present) indicates the fraction of residues that have poor fit to the electron density. The numeric value is given above the bar.

Mol	Chain	Length	Quality of chain
1	A	420	 13% 86% 10%
1	B	420	 7% 84% 6% 9%
1	C	420	 28% 87% 9%
2	D	5	 80% 60% 20% 20%

2 Entry composition [i](#)

There are 10 unique types of molecules in this entry. The entry contains 18649 atoms, of which 8994 are hydrogens and 0 are deuteriums.

In the tables below, the ZeroOcc column contains the number of atoms modelled with zero occupancy, the AltConf column contains the number of residues with at least one atom in alternate conformation and the Trace column contains the number of residues modelled with at most 2 atoms.

- Molecule 1 is a protein called Cytochrome P450-SU1.

Mol	Chain	Residues	Atoms						ZeroOcc	AltConf	Trace
			Total	C	H	N	O	S			
1	A	380	5844	1832	2925	554	529	4	0	6	0
1	B	382	5840	1832	2925	551	528	4	0	1	0
1	C	382	5864	1838	2938	555	529	4	0	3	0

There are 63 discrepancies between the modelled and reference sequences:

Chain	Residue	Modelled	Actual	Comment	Reference
A	-20	MET	-	initiating methionine	UNP A0A3E2YLT4
A	-19	GLY	-	expression tag	UNP A0A3E2YLT4
A	-18	SER	-	expression tag	UNP A0A3E2YLT4
A	-17	SER	-	expression tag	UNP A0A3E2YLT4
A	-16	HIS	-	expression tag	UNP A0A3E2YLT4
A	-15	HIS	-	expression tag	UNP A0A3E2YLT4
A	-14	HIS	-	expression tag	UNP A0A3E2YLT4
A	-13	HIS	-	expression tag	UNP A0A3E2YLT4
A	-12	HIS	-	expression tag	UNP A0A3E2YLT4
A	-11	HIS	-	expression tag	UNP A0A3E2YLT4
A	-10	SER	-	expression tag	UNP A0A3E2YLT4
A	-9	SER	-	expression tag	UNP A0A3E2YLT4
A	-8	GLY	-	expression tag	UNP A0A3E2YLT4
A	-7	LEU	-	expression tag	UNP A0A3E2YLT4
A	-6	VAL	-	expression tag	UNP A0A3E2YLT4
A	-5	PRO	-	expression tag	UNP A0A3E2YLT4
A	-4	ARG	-	expression tag	UNP A0A3E2YLT4
A	-3	GLY	-	expression tag	UNP A0A3E2YLT4
A	-2	SER	-	expression tag	UNP A0A3E2YLT4
A	-1	HIS	-	expression tag	UNP A0A3E2YLT4
A	0	MET	-	expression tag	UNP A0A3E2YLT4
B	-20	MET	-	initiating methionine	UNP A0A3E2YLT4
B	-19	GLY	-	expression tag	UNP A0A3E2YLT4

Continued on next page...

Continued from previous page...

Chain	Residue	Modelled	Actual	Comment	Reference
B	-18	SER	-	expression tag	UNP A0A3E2YLT4
B	-17	SER	-	expression tag	UNP A0A3E2YLT4
B	-16	HIS	-	expression tag	UNP A0A3E2YLT4
B	-15	HIS	-	expression tag	UNP A0A3E2YLT4
B	-14	HIS	-	expression tag	UNP A0A3E2YLT4
B	-13	HIS	-	expression tag	UNP A0A3E2YLT4
B	-12	HIS	-	expression tag	UNP A0A3E2YLT4
B	-11	HIS	-	expression tag	UNP A0A3E2YLT4
B	-10	SER	-	expression tag	UNP A0A3E2YLT4
B	-9	SER	-	expression tag	UNP A0A3E2YLT4
B	-8	GLY	-	expression tag	UNP A0A3E2YLT4
B	-7	LEU	-	expression tag	UNP A0A3E2YLT4
B	-6	VAL	-	expression tag	UNP A0A3E2YLT4
B	-5	PRO	-	expression tag	UNP A0A3E2YLT4
B	-4	ARG	-	expression tag	UNP A0A3E2YLT4
B	-3	GLY	-	expression tag	UNP A0A3E2YLT4
B	-2	SER	-	expression tag	UNP A0A3E2YLT4
B	-1	HIS	-	expression tag	UNP A0A3E2YLT4
B	0	MET	-	expression tag	UNP A0A3E2YLT4
C	-20	MET	-	initiating methionine	UNP A0A3E2YLT4
C	-19	GLY	-	expression tag	UNP A0A3E2YLT4
C	-18	SER	-	expression tag	UNP A0A3E2YLT4
C	-17	SER	-	expression tag	UNP A0A3E2YLT4
C	-16	HIS	-	expression tag	UNP A0A3E2YLT4
C	-15	HIS	-	expression tag	UNP A0A3E2YLT4
C	-14	HIS	-	expression tag	UNP A0A3E2YLT4
C	-13	HIS	-	expression tag	UNP A0A3E2YLT4
C	-12	HIS	-	expression tag	UNP A0A3E2YLT4
C	-11	HIS	-	expression tag	UNP A0A3E2YLT4
C	-10	SER	-	expression tag	UNP A0A3E2YLT4
C	-9	SER	-	expression tag	UNP A0A3E2YLT4
C	-8	GLY	-	expression tag	UNP A0A3E2YLT4
C	-7	LEU	-	expression tag	UNP A0A3E2YLT4
C	-6	VAL	-	expression tag	UNP A0A3E2YLT4
C	-5	PRO	-	expression tag	UNP A0A3E2YLT4
C	-4	ARG	-	expression tag	UNP A0A3E2YLT4
C	-3	GLY	-	expression tag	UNP A0A3E2YLT4
C	-2	SER	-	expression tag	UNP A0A3E2YLT4
C	-1	HIS	-	expression tag	UNP A0A3E2YLT4
C	0	MET	-	expression tag	UNP A0A3E2YLT4

- Molecule 2 is a protein called MET-ARG-TYR-LEU-HIS.

Mol	Chain	Residues	Atoms					ZeroOcc	AltConf	Trace	
			Total	C	H	N	O				S
2	D	5	101	32	51	10	7	1	0	0	0

- Molecule 3 is ACETATE ION (three-letter code: ACT) (formula: C₂H₃O₂).



Mol	Chain	Residues	Atoms				ZeroOcc	AltConf
			Total	C	H	O		
3	A	1	7	2	3	2	0	0
3	A	1	7	2	3	2	0	0
3	A	1	7	2	3	2	0	0
3	A	1	7	2	3	2	0	0
3	B	1	7	2	3	2	0	0
3	B	1	14	4	6	4	0	1

- Molecule 4 is TETRAETHYLENE GLYCOL (three-letter code: PG4) (formula: C₈H₁₈O₅).



Mol	Chain	Residues	Atoms				ZeroOcc	AltConf
			Total	C	H	O		
4	A	1	31	8	18	5	0	0

- Molecule 5 is PROTOPORPHYRIN IX CONTAINING FE (three-letter code: HEM) (formula: $C_{34}H_{32}FeN_4O_4$).

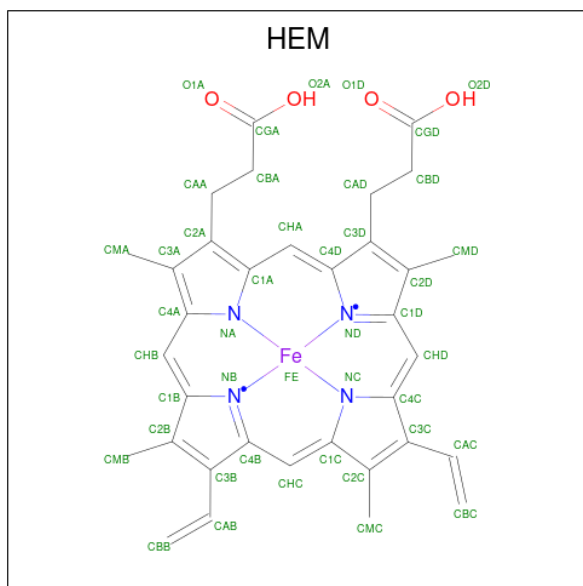

Mol	Chain	Residues	Atoms						ZeroOcc	AltConf
			Total	C	Fe	H	N	O		
5	A	1	73	34	1	30	4	4	0	0
5	B	1	73	34	1	30	4	4	0	0

Continued on next page...

Continued from previous page...

Mol	Chain	Residues	Atoms					ZeroOcc	AltConf	
			Total	C	Fe	H	N			O
5	C	1	73	34	1	30	4	4	0	0

- Molecule 6 is SODIUM ION (three-letter code: NA) (formula: Na).

Mol	Chain	Residues	Atoms		ZeroOcc	AltConf
6	A	3	Total	Na	0	0
			3	3		
6	B	1	Total	Na	0	0
			1	1		
6	C	1	Total	Na	0	0
			1	1		

- Molecule 7 is 2-[2-(2-METHOXY-ETHOXY)-ETHOXY]-ETHOXYL (three-letter code: TOE) (formula: C₇H₁₆O₄).

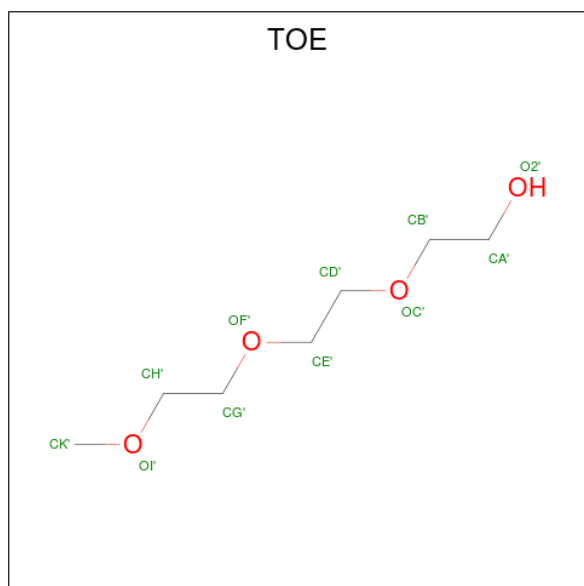

Mol	Chain	Residues	Atoms				ZeroOcc	AltConf
7	B	1	Total	C	H	O	0	0
			27	7	16	4		

- Molecule 8 is MESO-ERYTHRITOL (three-letter code: MRY) (formula: C₄H₁₀O₄).

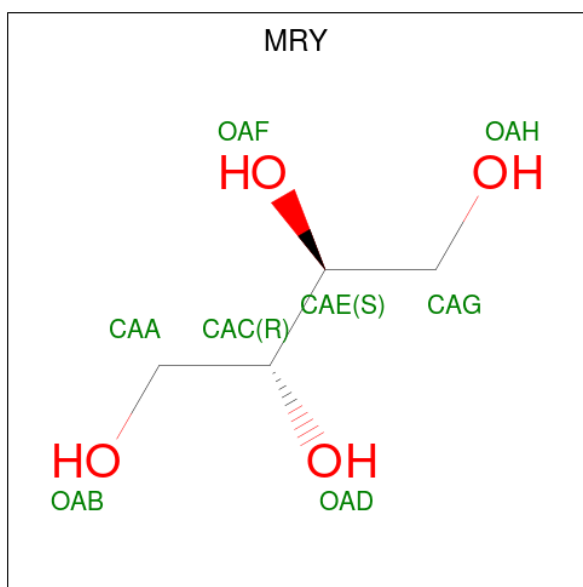

Mol	Chain	Residues	Atoms				ZeroOcc	AltConf
			Total	C	H	O		
8	B	1	18	4	10	4	0	0

- Molecule 9 is trifluoroacetic acid (three-letter code: TFA) (formula: $C_2HF_3O_2$).

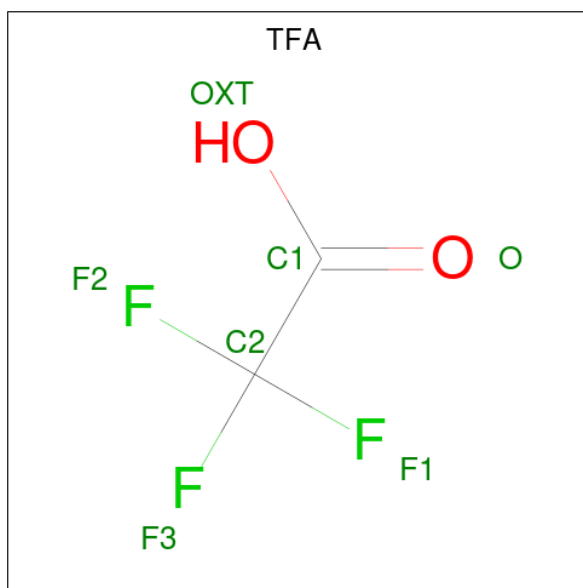

Mol	Chain	Residues	Atoms				ZeroOcc	AltConf
			Total	C	F	O		
9	B	1	7	2	3	2	0	0
9	B	1	7	2	3	2	0	0
9	C	1	7	2	3	2	0	0

Continued on next page...

Continued from previous page...

Mol	Chain	Residues	Atoms				ZeroOcc	AltConf
9	C	1	Total	C	F	O	0	0
			7	2	3	2		

- Molecule 10 is water.

Mol	Chain	Residues	Atoms		ZeroOcc	AltConf
10	A	201	Total	O	0	0
			201	201		
10	B	271	Total	O	0	0
			271	271		
10	C	148	Total	O	0	0
			148	148		
10	D	3	Total	O	0	0
			3	3		

3 Residue-property plots [i](#)

These plots are drawn for all protein, RNA, DNA and oligosaccharide chains in the entry. The first graphic for a chain summarises the proportions of the various outlier classes displayed in the second graphic. The second graphic shows the sequence view annotated by issues in geometry and electron density. Residues are color-coded according to the number of geometric quality criteria for which they contain at least one outlier: green = 0, yellow = 1, orange = 2 and red = 3 or more. A red dot above a residue indicates a poor fit to the electron density ($RSRZ > 2$). Stretches of 2 or more consecutive residues without any outlier are shown as a green connector. Residues present in the sample, but not in the model, are shown in grey.

- Molecule 1: Cytochrome P450-SU1

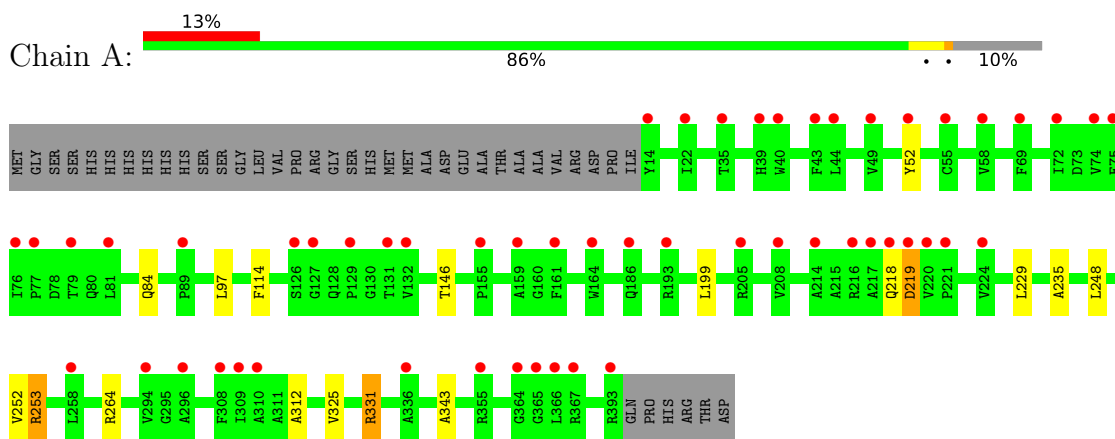

- Molecule 1: Cytochrome P450-SU1

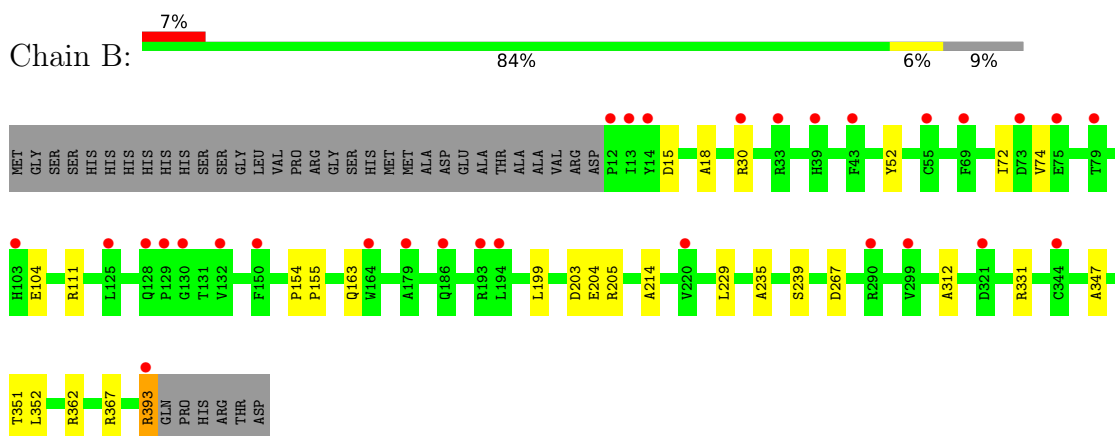

- Molecule 1: Cytochrome P450-SU1

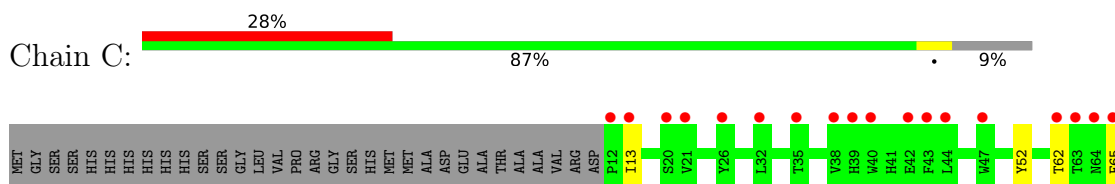

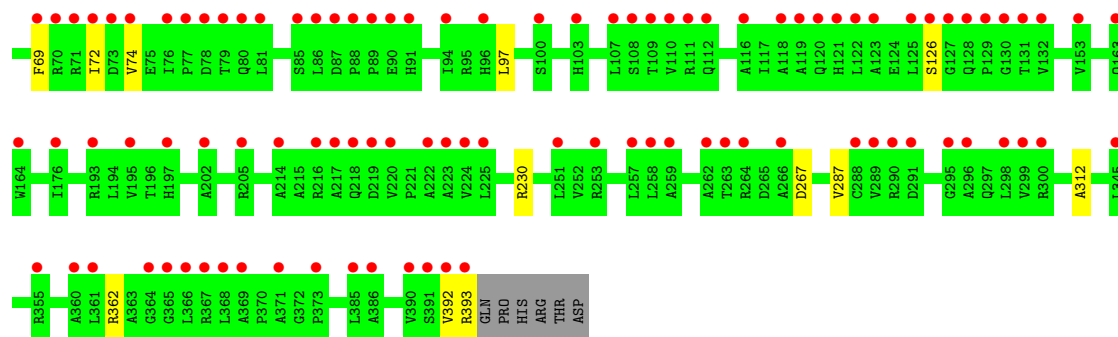

- Molecule 2: MET-ARG-TYR-LEU-HIS

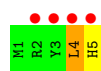
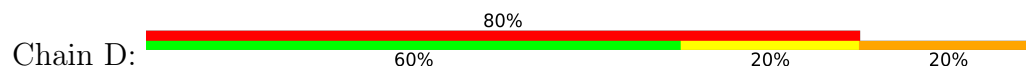

4 Data and refinement statistics

Property	Value	Source
Space group	P 1 21 1	Depositor
Cell constants a, b, c, α , β , γ	61.67Å 95.61Å 105.76Å 90.00° 92.71° 90.00°	Depositor
Resolution (Å)	47.80 – 1.79 47.80 – 1.79	Depositor EDS
% Data completeness (in resolution range)	99.0 (47.80-1.79) 99.0 (47.80-1.79)	Depositor EDS
R_{merge}	0.07	Depositor
R_{sym}	(Not available)	Depositor
$\langle I/\sigma(I) \rangle$ ¹	1.23 (at 1.79Å)	Xtrriage
Refinement program	PHENIX 1.20.1_4487	Depositor
R, R_{free}	0.199 , 0.229 0.198 , 0.228	Depositor DCC
R_{free} test set	5635 reflections (4.93%)	wwPDB-VP
Wilson B-factor (Å ²)	24.9	Xtrriage
Anisotropy	0.339	Xtrriage
Bulk solvent k_{sol} (e/Å ³), B_{sol} (Å ²)	0.42 , 48.4	EDS
L-test for twinning ²	$\langle L \rangle = 0.49$, $\langle L^2 \rangle = 0.32$	Xtrriage
Estimated twinning fraction	0.023 for h,-k,-l	Xtrriage
F_o, F_c correlation	0.96	EDS
Total number of atoms	18649	wwPDB-VP
Average B, all atoms (Å ²)	40.0	wwPDB-VP

Xtrriage's analysis on translational NCS is as follows: *The largest off-origin peak in the Patterson function is 4.02% of the height of the origin peak. No significant pseudotranslation is detected.*

¹Intensities estimated from amplitudes.

²Theoretical values of $\langle |L| \rangle$, $\langle L^2 \rangle$ for acentric reflections are 0.5, 0.333 respectively for untwinned datasets, and 0.375, 0.2 for perfectly twinned datasets.

5 Model quality [i](#)

5.1 Standard geometry [i](#)

Bond lengths and bond angles in the following residue types are not validated in this section: ACT, HEM, MRY, TOE, TFA, PG4, NA

The Z score for a bond length (or angle) is the number of standard deviations the observed value is removed from the expected value. A bond length (or angle) with $|Z| > 5$ is considered an outlier worth inspection. RMSZ is the root-mean-square of all Z scores of the bond lengths (or angles).

Mol	Chain	Bond lengths		Bond angles	
		RMSZ	# Z >5	RMSZ	# Z >5
1	A	0.26	0/3011	0.56	0/4109
1	B	0.26	0/2979	0.57	0/4065
1	C	0.26	0/2996	0.56	0/4087
2	D	0.35	0/51	0.57	0/65
All	All	0.26	0/9037	0.57	0/12326

There are no bond length outliers.

There are no bond angle outliers.

There are no chirality outliers.

There are no planarity outliers.

5.2 Too-close contacts [i](#)

In the following table, the Non-H and H(model) columns list the number of non-hydrogen atoms and hydrogen atoms in the chain respectively. The H(added) column lists the number of hydrogen atoms added and optimized by MolProbity. The Clashes column lists the number of clashes within the asymmetric unit, whereas Symm-Clashes lists symmetry-related clashes.

Mol	Chain	Non-H	H(model)	H(added)	Clashes	Symm-Clashes
1	A	2919	2925	2900	13	0
1	B	2915	2925	2923	17	0
1	C	2926	2938	2931	9	0
2	D	50	51	51	2	0
3	A	16	12	12	2	0
3	B	12	9	9	0	0
4	A	13	18	18	0	0
5	A	43	30	30	4	0
5	B	43	30	30	6	0

Continued on next page...

Continued from previous page...

Mol	Chain	Non-H	H(model)	H(added)	Clashes	Symm-Clashes
5	C	43	30	30	4	0
6	A	3	0	0	0	0
6	B	1	0	0	0	0
6	C	1	0	0	0	0
7	B	11	16	16	1	0
8	B	8	10	10	2	0
9	B	14	0	0	0	0
9	C	14	0	0	1	0
10	A	201	0	0	1	0
10	B	271	0	0	4	0
10	C	148	0	0	0	0
10	D	3	0	0	0	0
All	All	9655	8994	8960	53	0

The all-atom clashscore is defined as the number of clashes found per 1000 atoms (including hydrogen atoms). The all-atom clashscore for this structure is 3.

All (53) close contacts within the same asymmetric unit are listed below, sorted by their clash magnitude.

Atom-1	Atom-2	Interatomic distance (Å)	Clash overlap (Å)
1:A:325:VAL:H	3:A:401:ACT:H1	1.52	0.75
5:B:404:HEM:HBB2	5:B:404:HEM:HHC	1.74	0.70
5:B:404:HEM:HMC2	5:B:404:HEM:HBC2	1.75	0.68
1:B:111:ARG:HG3	1:B:352:LEU:HD11	1.81	0.63
1:A:235:ALA:HB2	2:D:5:HIS:CD2	2.36	0.61
1:B:267:ASP:OD2	1:B:362:ARG:NH2	2.35	0.58
5:B:404:HEM:HBC2	5:B:404:HEM:CMC	2.36	0.54
5:A:406:HEM:HBB2	5:A:406:HEM:HMB2	1.90	0.53
1:B:163:GLN:NE2	10:B:504:HOH:O	2.41	0.52
5:C:401:HEM:HMB2	5:C:401:HEM:HBB2	1.91	0.52
1:C:72:ILE:HG13	1:C:74:VAL:HG23	1.93	0.51
1:A:253:ARG:NH2	10:A:504:HOH:O	2.43	0.51
1:A:343:ALA:HB1	3:A:402:ACT:H1	1.94	0.50
5:C:401:HEM:CMC	5:C:401:HEM:HBC2	2.43	0.49
5:C:401:HEM:HBB2	5:C:401:HEM:CMB	2.43	0.48
5:A:406:HEM:HBB2	5:A:406:HEM:CMB	2.44	0.47
5:A:406:HEM:HBC2	5:A:406:HEM:CMC	2.45	0.47
1:A:218:GLN:O	1:A:219:ASP:HB3	2.15	0.47
1:B:199:LEU:HD21	1:B:229:LEU:CD1	2.45	0.47
1:A:248:LEU:O	1:A:252:VAL:HG13	2.16	0.46
1:A:52:TYR:HA	1:A:312:ALA:HB1	1.97	0.46

Continued on next page...

Continued from previous page...

Atom-1	Atom-2	Interatomic distance (Å)	Clash overlap (Å)
5:A:406:HEM:HBC2	5:A:406:HEM:HMC1	1.98	0.46
1:A:331:ARG:CZ	1:A:331:ARG:HB2	2.45	0.45
1:C:52:TYR:HA	1:C:312:ALA:HB1	1.98	0.45
1:C:69:PHE:CE1	1:C:287:VAL:HG13	2.52	0.45
1:B:15:ASP:HB3	1:B:18:ALA:HB2	1.99	0.45
7:B:402:TOE:H2	10:B:670:HOH:O	2.17	0.45
1:C:267:ASP:OD1	1:C:362:ARG:NH2	2.47	0.45
1:A:114:PHE:CE1	1:A:146:THR:HG23	2.51	0.45
5:C:401:HEM:HBC2	5:C:401:HEM:HMC1	1.99	0.45
1:B:30:ARG:NH1	10:B:511:HOH:O	2.50	0.44
1:B:104:GLU:OE1	8:B:403:MRY:OAB	2.29	0.44
5:B:404:HEM:HBB2	5:B:404:HEM:CHC	2.44	0.44
1:B:203:ASP:OD1	1:B:204:GLU:N	2.51	0.44
1:A:97:LEU:C	1:A:97:LEU:HD23	2.38	0.44
1:C:230:ARG:NH2	9:C:403:TFA:O	2.52	0.43
1:C:126:SER:HA	1:C:392:VAL:HG11	2.01	0.42
1:B:367:ARG:HG2	1:B:393:ARG:HD2	2.01	0.42
1:B:239:SER:HB3	5:B:404:HEM:C3B	2.54	0.42
1:B:203:ASP:OD1	1:B:205:ARG:N	2.51	0.42
1:A:84[B]:GLN:HE21	2:D:4:LEU:HD13	1.85	0.41
1:A:218:GLN:O	1:A:219:ASP:CB	2.67	0.41
1:B:72:ILE:HG13	1:B:74:VAL:HG23	2.00	0.41
1:C:392:VAL:O	1:C:393:ARG:HG3	2.20	0.41
1:C:62:THR:HA	1:C:65:PHE:O	2.21	0.41
1:B:154:PRO:HA	1:B:155:PRO:HD3	2.00	0.41
1:B:347:ALA:O	1:B:351:THR:HG23	2.21	0.41
5:B:404:HEM:HHC	5:B:404:HEM:CBB	2.47	0.41
1:B:52:TYR:HA	1:B:312:ALA:HB1	2.01	0.40
1:B:214:ALA:HB2	8:B:403:MRY:CAA	2.51	0.40
1:A:199:LEU:HD21	1:A:229:LEU:CD1	2.52	0.40
1:B:235:ALA:HB1	10:B:572:HOH:O	2.21	0.40
1:C:97:LEU:HD23	1:C:97:LEU:C	2.42	0.40

There are no symmetry-related clashes.

5.3 Torsion angles [i](#)

5.3.1 Protein backbone [i](#)

In the following table, the Percentiles column shows the percent Ramachandran outliers of the chain as a percentile score with respect to all X-ray entries followed by that with respect to entries

of similar resolution.

The Analysed column shows the number of residues for which the backbone conformation was analysed, and the total number of residues.

Mol	Chain	Analysed	Favoured	Allowed	Outliers	Percentiles	
1	A	384/420 (91%)	379 (99%)	4 (1%)	1 (0%)	41	27
1	B	381/420 (91%)	378 (99%)	3 (1%)	0	100	100
1	C	383/420 (91%)	377 (98%)	6 (2%)	0	100	100
2	D	3/5 (60%)	3 (100%)	0	0	100	100
All	All	1151/1265 (91%)	1137 (99%)	13 (1%)	1 (0%)	51	36

All (1) Ramachandran outliers are listed below:

Mol	Chain	Res	Type
1	A	219	ASP

5.3.2 Protein sidechains [i](#)

In the following table, the Percentiles column shows the percent sidechain outliers of the chain as a percentile score with respect to all X-ray entries followed by that with respect to entries of similar resolution.

The Analysed column shows the number of residues for which the sidechain conformation was analysed, and the total number of residues.

Mol	Chain	Analysed	Rotameric	Outliers	Percentiles	
1	A	298/325 (92%)	295 (99%)	3 (1%)	76	71
1	B	295/325 (91%)	293 (99%)	2 (1%)	84	81
1	C	297/325 (91%)	296 (100%)	1 (0%)	92	91
2	D	5/5 (100%)	4 (80%)	1 (20%)	1	0
All	All	895/980 (91%)	888 (99%)	7 (1%)	81	78

All (7) residues with a non-rotameric sidechain are listed below:

Mol	Chain	Res	Type
1	A	253	ARG
1	A	264	ARG
1	A	331	ARG
1	B	331	ARG
1	B	393	ARG

Continued on next page...

Continued from previous page...

Mol	Chain	Res	Type
1	C	13	ILE
2	D	4	LEU

Sometimes sidechains can be flipped to improve hydrogen bonding and reduce clashes. There are no such sidechains identified.

5.3.3 RNA [i](#)

There are no RNA molecules in this entry.

5.4 Non-standard residues in protein, DNA, RNA chains [i](#)

There are no non-standard protein/DNA/RNA residues in this entry.

5.5 Carbohydrates [i](#)

There are no monosaccharides in this entry.

5.6 Ligand geometry [i](#)

Of 22 ligands modelled in this entry, 5 are monoatomic - leaving 17 for Mogul analysis.

In the following table, the Counts columns list the number of bonds (or angles) for which Mogul statistics could be retrieved, the number of bonds (or angles) that are observed in the model and the number of bonds (or angles) that are defined in the Chemical Component Dictionary. The Link column lists molecule types, if any, to which the group is linked. The Z score for a bond length (or angle) is the number of standard deviations the observed value is removed from the expected value. A bond length (or angle) with $|Z| > 2$ is considered an outlier worth inspection. RMSZ is the root-mean-square of all Z scores of the bond lengths (or angles).

Mol	Type	Chain	Res	Link	Bond lengths			Bond angles		
					Counts	RMSZ	$\# Z > 2$	Counts	RMSZ	$\# Z > 2$
3	ACT	B	401	-	3,3,3	1.44	0	3,3,3	1.57	1 (33%)
9	TFA	C	402	-	6,6,6	1.02	0	9,9,9	0.97	0
7	TOE	B	402	-	10,10,10	0.30	0	9,9,9	0.39	0
9	TFA	B	407	-	6,6,6	1.06	0	9,9,9	0.95	0
3	ACT	A	402	-	3,3,3	1.46	0	3,3,3	1.42	0
5	HEM	C	401	1	41,50,50	1.44	4 (9%)	45,82,82	1.40	5 (11%)
5	HEM	B	404	1,10	41,50,50	1.44	3 (7%)	45,82,82	1.53	10 (22%)
4	PG4	A	403	-	12,12,12	0.12	0	11,11,11	0.58	0

Mol	Type	Chain	Res	Link	Bond lengths			Bond angles		
					Counts	RMSZ	# Z > 2	Counts	RMSZ	# Z > 2
8	MRY	B	403	-	7,7,7	0.49	0	8,8,8	0.95	0
3	ACT	A	404	-	3,3,3	1.40	0	3,3,3	2.04	1 (33%)
9	TFA	C	403	-	6,6,6	1.09	0	9,9,9	0.95	0
3	ACT	B	405[A]	-	3,3,3	1.40	0	3,3,3	1.91	1 (33%)
9	TFA	B	406	-	6,6,6	1.01	0	9,9,9	0.94	0
3	ACT	A	401	-	3,3,3	1.36	0	3,3,3	1.93	1 (33%)
3	ACT	B	405[B]	-	3,3,3	1.40	0	3,3,3	1.85	1 (33%)
3	ACT	A	405	-	3,3,3	1.42	0	3,3,3	1.88	1 (33%)
5	HEM	A	406	1,10	41,50,50	1.46	3 (7%)	45,82,82	1.43	7 (15%)

In the following table, the Chirals column lists the number of chiral outliers, the number of chiral centers analysed, the number of these observed in the model and the number defined in the Chemical Component Dictionary. Similar counts are reported in the Torsion and Rings columns. '-' means no outliers of that kind were identified.

Mol	Type	Chain	Res	Link	Chirals	Torsions	Rings
9	TFA	C	402	-	-	0/6/6/6	-
7	TOE	B	402	-	-	7/8/8/8	-
9	TFA	B	407	-	-	0/6/6/6	-
5	HEM	C	401	1	-	2/12/54/54	-
5	HEM	B	404	1,10	-	4/12/54/54	-
4	PG4	A	403	-	-	4/10/10/10	-
8	MRY	B	403	-	-	6/8/8/8	-
9	TFA	C	403	-	-	0/6/6/6	-
9	TFA	B	406	-	-	0/6/6/6	-
5	HEM	A	406	1,10	-	2/12/54/54	-

All (10) bond length outliers are listed below:

Mol	Chain	Res	Type	Atoms	Z	Observed(Å)	Ideal(Å)
5	B	404	HEM	C3C-C2C	-4.10	1.34	1.40
5	A	406	HEM	C3C-C2C	-4.06	1.34	1.40
5	C	401	HEM	C3C-C2C	-4.04	1.34	1.40
5	B	404	HEM	C3C-CAC	3.57	1.55	1.47
5	C	401	HEM	C3C-CAC	3.46	1.54	1.47
5	A	406	HEM	C3C-CAC	3.45	1.54	1.47
5	A	406	HEM	CAB-C3B	2.88	1.55	1.47
5	C	401	HEM	CAB-C3B	2.84	1.55	1.47
5	B	404	HEM	CAB-C3B	2.64	1.54	1.47
5	C	401	HEM	CMB-C2B	2.00	1.55	1.50

All (28) bond angle outliers are listed below:

Mol	Chain	Res	Type	Atoms	Z	Observed(°)	Ideal(°)
5	B	404	HEM	C4D-ND-C1D	3.02	108.20	105.07
5	A	406	HEM	C4D-ND-C1D	2.94	108.11	105.07
5	C	401	HEM	C1B-NB-C4B	2.86	108.03	105.07
5	B	404	HEM	C4C-CHD-C1D	2.84	126.30	122.56
3	A	404	ACT	O-C-CH3	-2.81	111.38	122.33
5	C	401	HEM	C4D-ND-C1D	2.81	107.97	105.07
5	B	404	HEM	C1B-NB-C4B	2.74	107.90	105.07
3	A	401	ACT	O-C-CH3	-2.68	111.90	122.33
5	A	406	HEM	C4B-CHC-C1C	2.66	126.06	122.56
5	A	406	HEM	CAD-CBD-CGD	-2.65	107.89	113.60
3	B	405[A]	ACT	O-C-CH3	-2.64	112.04	122.33
3	A	405	ACT	O-C-CH3	-2.61	112.17	122.33
5	A	406	HEM	C1B-NB-C4B	2.60	107.76	105.07
5	C	401	HEM	C4B-CHC-C1C	2.60	125.99	122.56
3	B	405[B]	ACT	O-C-CH3	-2.56	112.36	122.33
5	C	401	HEM	CAD-CBD-CGD	-2.52	108.17	113.60
5	B	404	HEM	CMC-C2C-C3C	2.34	129.05	124.68
5	A	406	HEM	C4C-CHD-C1D	2.33	125.64	122.56
5	B	404	HEM	CAA-CBA-CGA	-2.33	107.24	113.76
5	B	404	HEM	C4B-CHC-C1C	2.32	125.62	122.56
5	B	404	HEM	C3D-C4D-ND	-2.30	107.61	110.17
5	B	404	HEM	CHD-C1D-ND	2.28	126.91	124.43
5	B	404	HEM	CMA-C3A-C4A	-2.27	124.97	128.46
3	B	401	ACT	O-C-CH3	-2.18	113.85	122.33
5	B	404	HEM	C3B-C2B-C1B	2.17	108.10	106.49
5	A	406	HEM	CBA-CAA-C2A	-2.13	108.99	112.62
5	C	401	HEM	CBA-CAA-C2A	-2.12	109.01	112.62
5	A	406	HEM	CMA-C3A-C4A	-2.10	125.23	128.46

There are no chirality outliers.

All (25) torsion outliers are listed below:

Mol	Chain	Res	Type	Atoms
8	B	403	MRY	OAB-CAA-CAC-OAD
8	B	403	MRY	CAA-CAC-CAE-OAF
8	B	403	MRY	CAA-CAC-CAE-CAG
8	B	403	MRY	OAD-CAC-CAE-OAF
8	B	403	MRY	OAD-CAC-CAE-CAG
8	B	403	MRY	OAB-CAA-CAC-CAE
4	A	403	PG4	O2-C3-C4-O3
7	B	402	TOE	OF'-CG'-CH'-OI'

Continued on next page...

Continued from previous page...

Mol	Chain	Res	Type	Atoms
4	A	403	PG4	O1-C1-C2-O2
7	B	402	TOE	OC'-CD'-CE'-OF'
4	A	403	PG4	C8-C7-O4-C6
4	A	403	PG4	C4-C3-O2-C2
7	B	402	TOE	O2'-CA'-CB'-OC'
5	B	404	HEM	CAA-CBA-CGA-O1A
7	B	402	TOE	CE'-CD'-OC'-CB'
7	B	402	TOE	CG'-CH'-OF'-CK'
5	C	401	HEM	CAD-CBD-CGD-O2D
5	A	406	HEM	CAD-CBD-CGD-O2D
5	B	404	HEM	CAA-CBA-CGA-O2A
5	C	401	HEM	CAD-CBD-CGD-O1D
7	B	402	TOE	CH'-CG'-OF'-CE'
5	A	406	HEM	CAD-CBD-CGD-O1D
5	B	404	HEM	CAD-CBD-CGD-O1D
5	B	404	HEM	CAD-CBD-CGD-O2D
7	B	402	TOE	CA'-CB'-OC'-CD'

There are no ring outliers.

8 monomers are involved in 20 short contacts:

Mol	Chain	Res	Type	Clashes	Symm-Clashes
7	B	402	TOE	1	0
3	A	402	ACT	1	0
5	C	401	HEM	4	0
5	B	404	HEM	6	0
8	B	403	MRY	2	0
9	C	403	TFA	1	0
3	A	401	ACT	1	0
5	A	406	HEM	4	0

The following is a two-dimensional graphical depiction of Mogul quality analysis of bond lengths, bond angles, torsion angles, and ring geometry for all instances of the Ligand of Interest. In addition, ligands with molecular weight > 250 and outliers as shown on the validation Tables will also be included. For torsion angles, if less than 5% of the Mogul distribution of torsion angles is within 10 degrees of the torsion angle in question, then that torsion angle is considered an outlier. Any bond that is central to one or more torsion angles identified as an outlier by Mogul will be highlighted in the graph. For rings, the root-mean-square deviation (RMSD) between the ring in question and similar rings identified by Mogul is calculated over all ring torsion angles. If the average RMSD is greater than 60 degrees and the minimal RMSD between the ring in question and any Mogul-identified rings is also greater than 60 degrees, then that ring is considered an outlier. The outliers are highlighted in purple. The color gray indicates Mogul did not find sufficient

equivalents in the CSD to analyse the geometry.

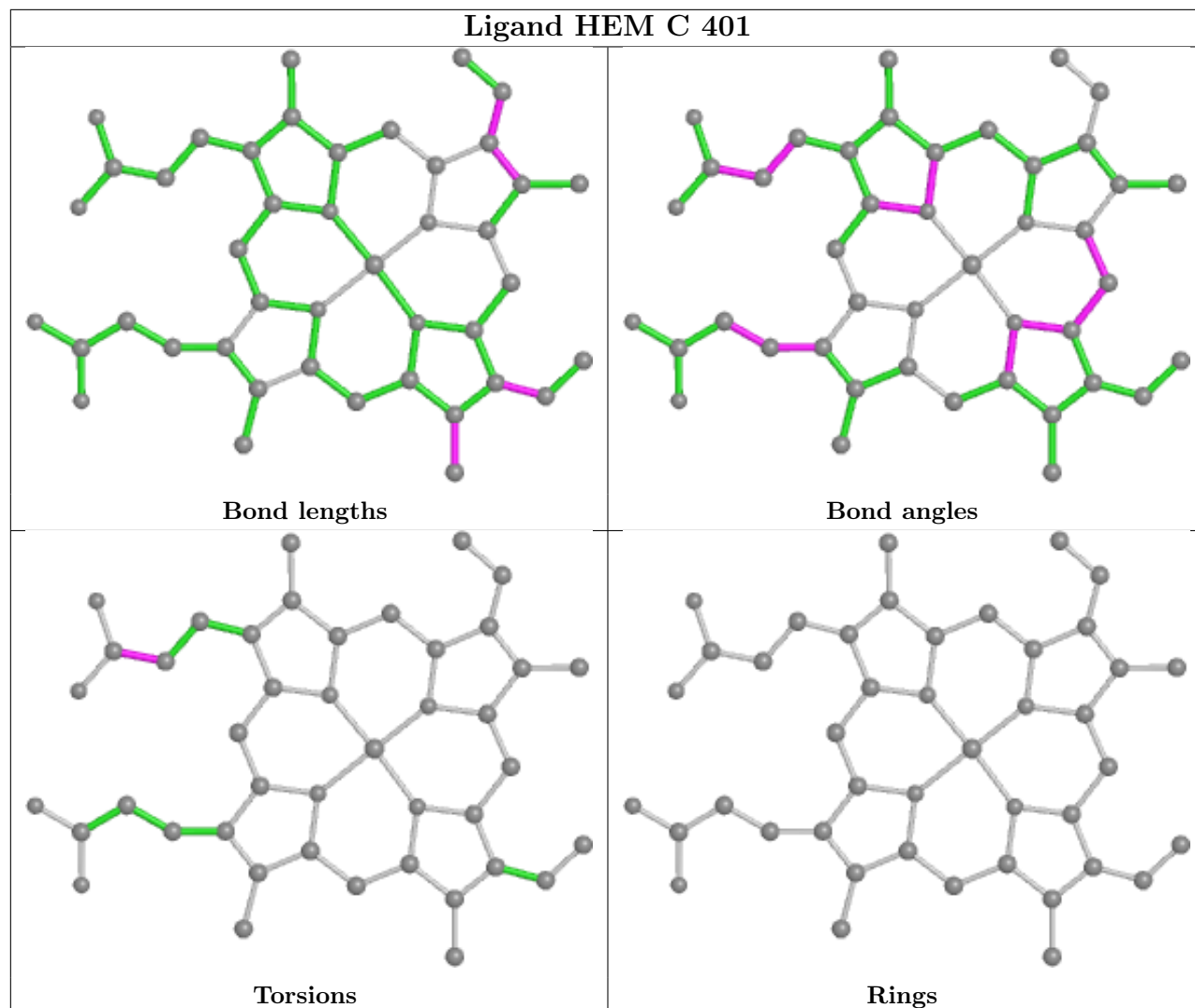

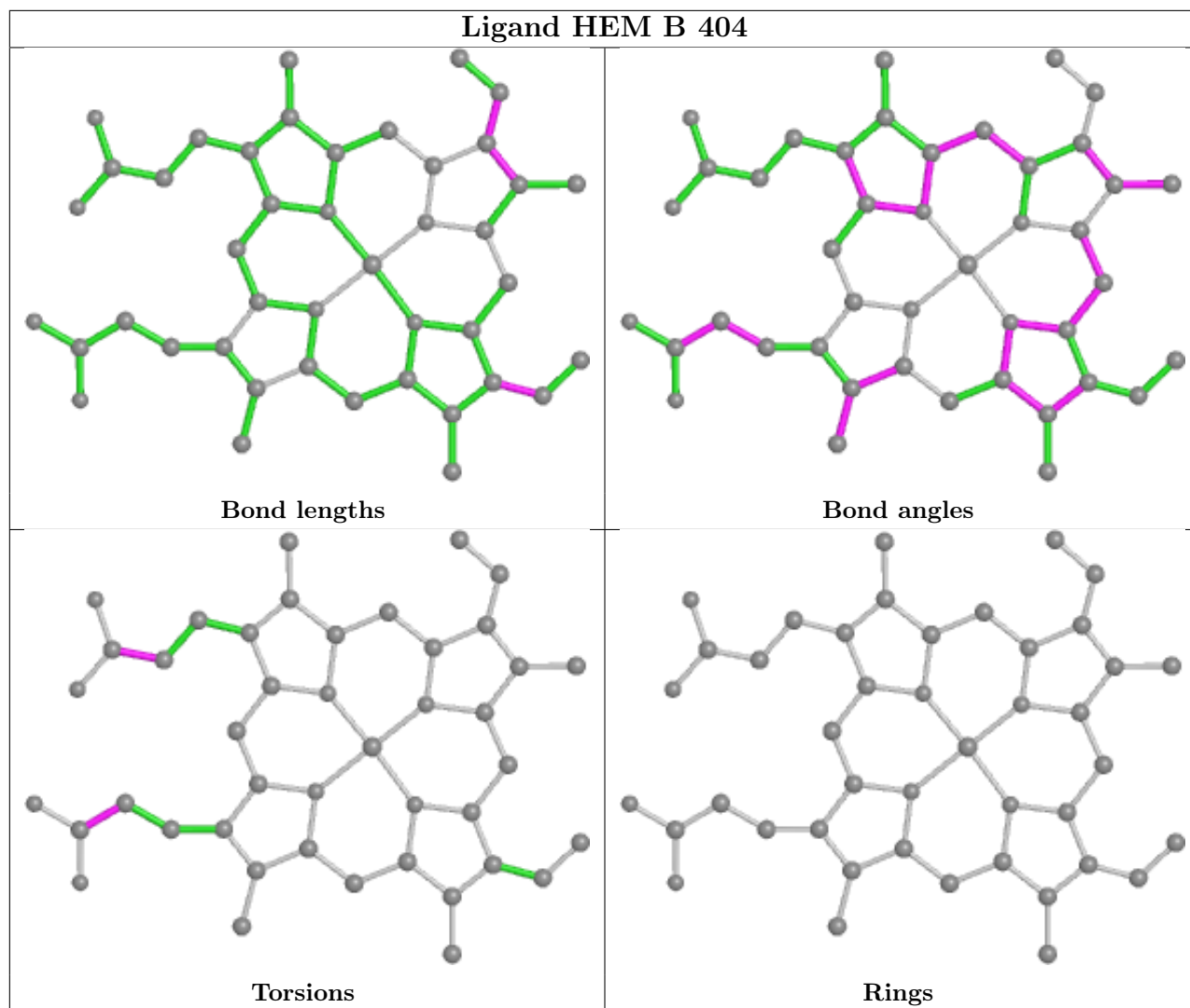

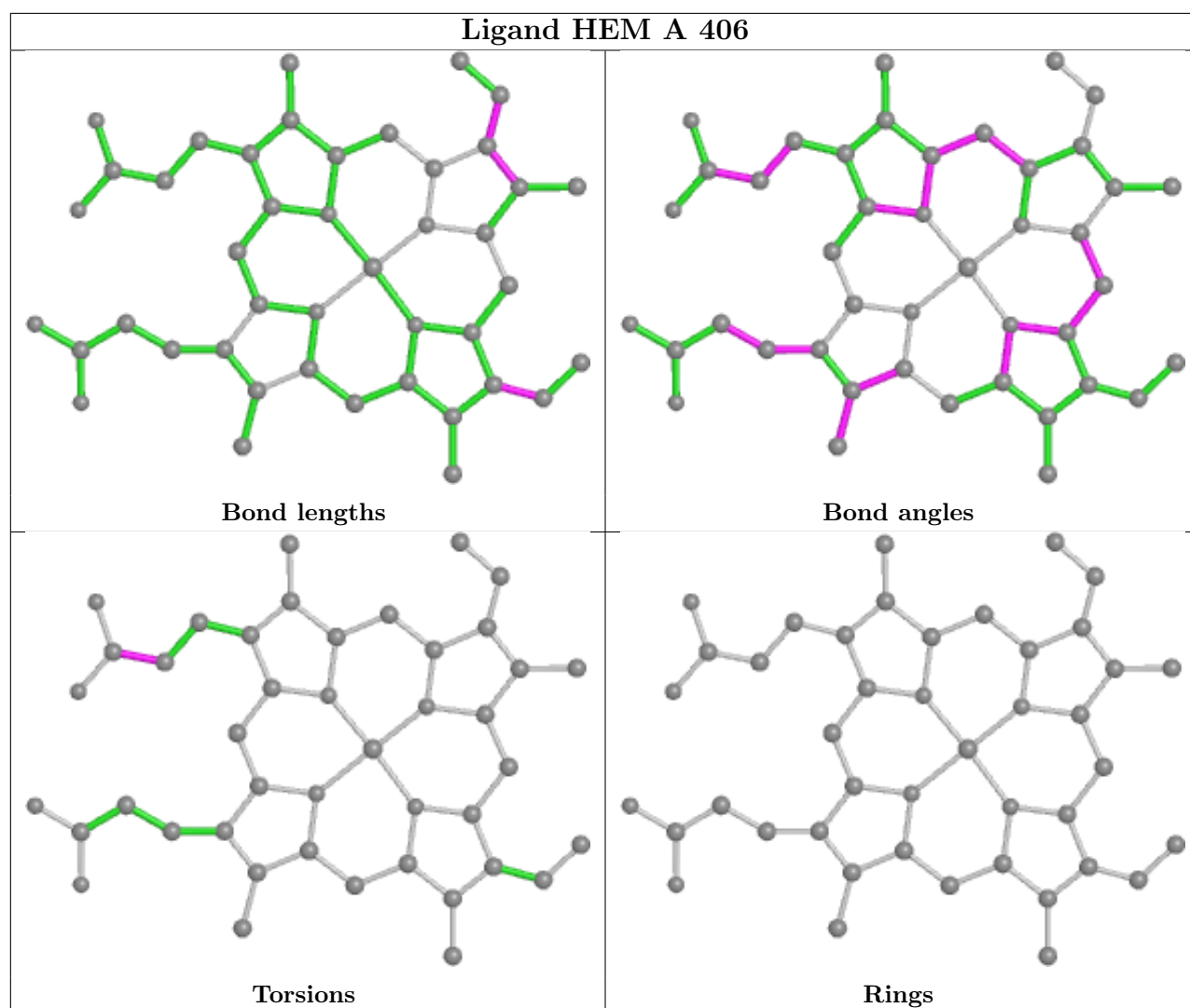

5.7 Other polymers [i](#)

There are no such residues in this entry.

5.8 Polymer linkage issues [i](#)

There are no chain breaks in this entry.

6 Fit of model and data [i](#)

6.1 Protein, DNA and RNA chains [i](#)

In the following table, the column labelled ‘#RSRZ > 2’ contains the number (and percentage) of RSRZ outliers, followed by percent RSRZ outliers for the chain as percentile scores relative to all X-ray entries and entries of similar resolution. The OWAB column contains the minimum, median, 95th percentile and maximum values of the occupancy-weighted average B-factor per residue. The column labelled ‘Q < 0.9’ lists the number of (and percentage) of residues with an average occupancy less than 0.9.

Mol	Chain	Analysed	<RSRZ>	#RSRZ>2	OWAB(Å ²)	Q<0.9
1	A	380/420 (90%)	1.35	54 (14%) 2 1	18, 29, 60, 86	0
1	B	382/420 (90%)	1.06	30 (7%) 12 9	17, 27, 49, 68	0
1	C	382/420 (90%)	1.79	117 (30%) 0 0	22, 42, 72, 95	0
2	D	5/5 (100%)	3.35	4 (80%) 0 0	40, 40, 47, 55	0
All	All	1149/1265 (90%)	1.41	205 (17%) 1 0	17, 32, 66, 95	0

All (205) RSRZ outliers are listed below:

Mol	Chain	Res	Type	RSRZ
1	C	365	GLY	17.3
1	B	13	ILE	7.9
1	C	220	VAL	7.5
1	C	393	ARG	7.5
1	A	76	ILE	7.0
1	C	76	ILE	6.8
1	C	368	LEU	6.7
1	C	69	PHE	6.5
1	C	296	ALA	6.5
1	A	367	ARG	6.5
1	C	86	LEU	6.4
1	C	122	LEU	6.3
1	A	164	TRP	6.3
1	A	74	VAL	6.2
1	A	218	GLN	6.2
1	A	365	GLY	6.2
1	C	219	ASP	6.0
1	C	364	GLY	5.9
1	A	366	LEU	5.9
1	C	392	VAL	5.6
1	C	222	ALA	5.5

Continued on next page...

Continued from previous page...

Mol	Chain	Res	Type	RSRZ
1	A	217	ALA	5.2
1	A	126	SER	5.1
1	C	129	PRO	5.1
1	C	298	LEU	5.1
1	C	12	PRO	5.1
1	C	367	ARG	5.1
1	C	371	ALA	5.1
1	B	393	ARG	5.0
1	A	79	THR	4.9
1	C	131	THR	4.9
1	A	81	LEU	4.9
1	C	366	LEU	4.9
1	C	217	ALA	4.9
1	C	125	LEU	4.9
1	A	14	TYR	4.8
1	C	266	ALA	4.8
1	A	44	LEU	4.7
1	A	127	GLY	4.7
1	C	73	ASP	4.7
2	D	4	LEU	4.6
1	C	13	ILE	4.6
1	C	110	VAL	4.5
1	C	128	GLN	4.5
1	C	88	PRO	4.5
1	A	216	ARG	4.4
1	A	89	PRO	4.4
1	C	74	VAL	4.4
1	C	360	ALA	4.4
1	C	126	SER	4.4
1	C	72	ILE	4.2
1	C	299	VAL	4.2
2	D	2	ARG	4.1
1	A	43	PHE	4.1
1	C	43	PHE	4.1
1	B	73	ASP	4.1
1	C	214	ALA	4.0
1	C	112	GLN	3.9
1	C	123	ALA	3.9
1	C	258	LEU	3.9
1	B	69	PHE	3.9
1	C	290	ARG	3.9
1	C	223	ALA	3.8

Continued on next page...

Continued from previous page...

Mol	Chain	Res	Type	RSRZ
2	D	5	HIS	3.7
1	A	205	ARG	3.7
1	C	295	GLY	3.7
1	C	100	SER	3.6
1	C	80	GLN	3.6
1	C	40	TRP	3.6
1	C	94	ILE	3.6
1	C	62	THR	3.6
1	C	163	GLN	3.5
1	A	77	PRO	3.5
1	C	118	ALA	3.4
1	C	79	THR	3.4
1	A	159	ALA	3.4
1	C	373	PRO	3.3
1	B	129	PRO	3.3
1	B	128	GLN	3.3
1	A	219	ASP	3.3
1	A	364	GLY	3.3
1	B	132	VAL	3.2
1	C	77	PRO	3.2
1	C	63	THR	3.2
1	C	253	ARG	3.2
1	C	132	VAL	3.2
1	A	221	PRO	3.1
1	C	111	ARG	3.1
2	D	3	TYR	3.1
1	B	164	TRP	3.1
1	A	55	CYS	3.1
1	C	288	CYS	3.1
1	C	64	ASN	3.1
1	C	107	LEU	3.1
1	C	202	ALA	3.1
1	C	78	ASP	3.0
1	C	262	ALA	3.0
1	B	33[A]	ARG	3.0
1	A	161	PHE	3.0
1	C	390	VAL	3.0
1	A	193	ARG	2.9
1	C	224	VAL	2.9
1	C	386	ALA	2.9
1	C	205	ARG	2.9
1	C	120	GLN	2.9

Continued on next page...

Continued from previous page...

Mol	Chain	Res	Type	RSRZ
1	C	361	LEU	2.9
1	C	291	ASP	2.9
1	A	258	LEU	2.9
1	A	186	GLN	2.9
1	C	264	ARG	2.9
1	B	30	ARG	2.8
1	C	193	ARG	2.8
1	B	179	ALA	2.8
1	A	58	VAL	2.8
1	A	208	VAL	2.8
1	A	220	VAL	2.8
1	C	81	LEU	2.8
1	C	119	ALA	2.8
1	C	127	GLY	2.8
1	C	71	ARG	2.8
1	C	121	HIS	2.8
1	B	75	GLU	2.8
1	A	75	GLU	2.8
1	C	300	ARG	2.7
1	A	214	ALA	2.7
1	C	89	PRO	2.7
1	C	103	HIS	2.7
1	B	290	ARG	2.7
1	B	299	VAL	2.7
1	B	55	CYS	2.6
1	B	12	PRO	2.6
1	C	26	TYR	2.6
1	C	369	ALA	2.6
1	B	193	ARG	2.6
1	A	39[A]	HIS	2.6
1	A	132	VAL	2.6
1	C	225	LEU	2.6
1	B	344	CYS	2.5
1	B	43	PHE	2.5
1	C	87	ASP	2.5
1	C	218	GLN	2.5
1	A	72	ILE	2.5
1	C	289	VAL	2.5
1	C	216	ARG	2.4
1	C	21	VAL	2.4
1	A	310	ALA	2.4
1	B	14	TYR	2.4

Continued on next page...

Continued from previous page...

Mol	Chain	Res	Type	RSRZ
1	A	131	THR	2.4
1	B	130	GLY	2.3
1	C	47	TRP	2.3
1	C	391	SER	2.3
1	C	176	ILE	2.3
1	C	65	PHE	2.3
1	C	35	THR	2.3
1	C	164	TRP	2.3
1	C	195	VAL	2.3
1	B	194	LEU	2.3
1	C	32	LEU	2.3
1	C	251	LEU	2.3
1	B	103	HIS	2.3
1	A	69	PHE	2.3
1	A	355	ARG	2.3
1	B	186	GLN	2.3
1	A	155	PRO	2.3
1	C	197	HIS	2.3
1	A	224	VAL	2.2
1	C	20	SER	2.2
1	B	79	THR	2.2
1	A	296	ALA	2.2
1	B	125	LEU	2.2
1	C	70	ARG	2.2
1	C	257	LEU	2.2
1	A	40[A]	TRP	2.2
1	C	91	HIS	2.2
1	A	393	ARG	2.2
1	C	355	ARG	2.2
1	C	85	SER	2.2
1	A	35	THR	2.2
1	C	42	GLU	2.2
1	C	38	VAL	2.2
1	A	129	PRO	2.2
1	B	321	ASP	2.2
1	C	44	LEU	2.1
1	C	385	LEU	2.1
1	C	130	GLY	2.1
1	C	116	ALA	2.1
1	C	90	GLU	2.1
1	A	52	TYR	2.1
1	B	150	PHE	2.1

Continued on next page...

Continued from previous page...

Mol	Chain	Res	Type	RSRZ
1	C	96	HIS	2.1
1	C	259	ALA	2.1
1	C	345	LEU	2.1
1	C	263	THR	2.1
1	A	309	ILE	2.1
1	C	109	THR	2.0
1	A	49	VAL	2.0
1	A	308	PHE	2.0
1	C	153	VAL	2.0
1	B	39	HIS	2.0
1	A	22	ILE	2.0
1	A	336	ALA	2.0
1	C	39	HIS	2.0
1	C	108	SER	2.0
1	A	294	VAL	2.0
1	B	220	VAL	2.0

6.2 Non-standard residues in protein, DNA, RNA chains [i](#)

There are no non-standard protein/DNA/RNA residues in this entry.

6.3 Carbohydrates [i](#)

There are no monosaccharides in this entry.

6.4 Ligands [i](#)

In the following table, the Atoms column lists the number of modelled atoms in the group and the number defined in the chemical component dictionary. The B-factors column lists the minimum, median, 95th percentile and maximum values of B factors of atoms in the group. The column labelled 'Q< 0.9' lists the number of atoms with occupancy less than 0.9.

Mol	Type	Chain	Res	Atoms	RSCC	RSR	B-factors(Å ²)	Q<0.9
3	ACT	B	401	4/4	0.59	0.20	42,51,53,55	0
9	TFA	C	403	7/7	0.63	0.23	81,88,99,104	0
3	ACT	A	402	4/4	0.66	0.19	41,50,51,52	0
4	PG4	A	403	13/13	0.72	0.21	34,45,60,69	31
3	ACT	A	404	4/4	0.74	0.29	46,55,56,63	0
9	TFA	B	406	7/7	0.76	0.24	32,51,59,64	0
8	MRY	B	403	8/8	0.78	0.38	37,46,62,75	0

Continued on next page...

Continued from previous page...

Mol	Type	Chain	Res	Atoms	RSCC	RSR	B-factors(\AA^2)	Q<0.9
6	NA	A	409	1/1	0.79	0.21	51,51,51,51	0
7	TOE	B	402	11/11	0.82	0.20	30,45,54,56	27
9	TFA	C	402	7/7	0.84	0.15	29,48,55,67	0
9	TFA	B	407	7/7	0.85	0.23	42,54,62,68	0
3	ACT	A	405	4/4	0.87	0.16	35,38,42,45	7
3	ACT	B	405[A]	4/4	0.88	0.13	35,39,42,42	7
6	NA	C	404	1/1	0.88	0.11	50,50,50,50	0
3	ACT	B	405[B]	4/4	0.88	0.13	30,37,42,42	7
3	ACT	A	401	4/4	0.88	0.18	19,23,39,40	0
6	NA	A	408	1/1	0.90	0.27	55,55,55,55	0
5	HEM	C	401	43/43	0.92	0.15	20,28,37,44	0
6	NA	A	407	1/1	0.93	0.15	43,43,43,43	0
5	HEM	B	404	43/43	0.94	0.16	12,20,29,31	0
5	HEM	A	406	43/43	0.94	0.16	14,21,35,46	0
6	NA	B	408	1/1	0.96	0.09	51,51,51,51	0

The following is a graphical depiction of the model fit to experimental electron density of all instances of the Ligand of Interest. In addition, ligands with molecular weight > 250 and outliers as shown on the geometry validation Tables will also be included. Each fit is shown from different orientation to approximate a three-dimensional view.

Electron density around HEM C 401:

$2mF_o-DF_c$ (at 0.7 rmsd) in gray
 mF_o-DF_c (at 3 rmsd) in purple (negative)
and green (positive)

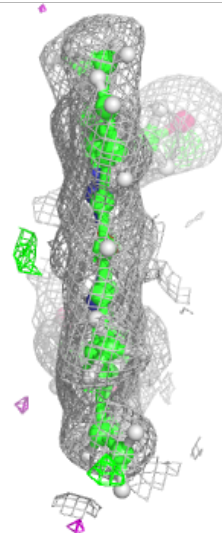
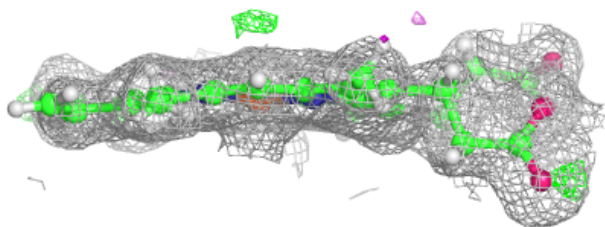
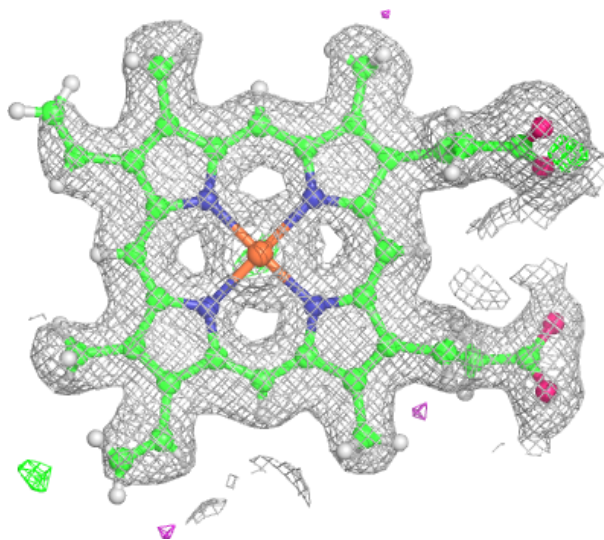

Electron density around HEM B 404:

$2mF_o-DF_c$ (at 0.7 rmsd) in gray
 mF_o-DF_c (at 3 rmsd) in purple (negative)
and green (positive)

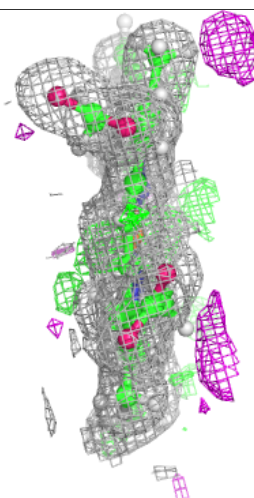
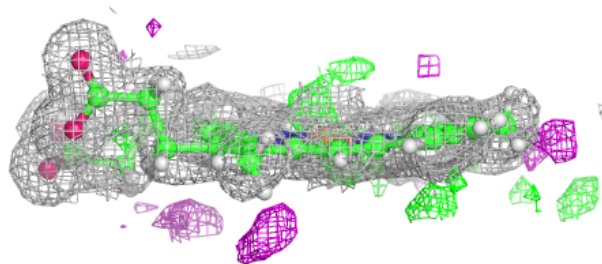
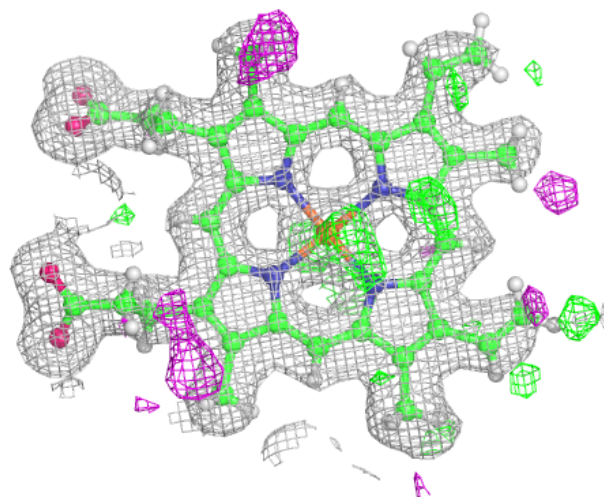

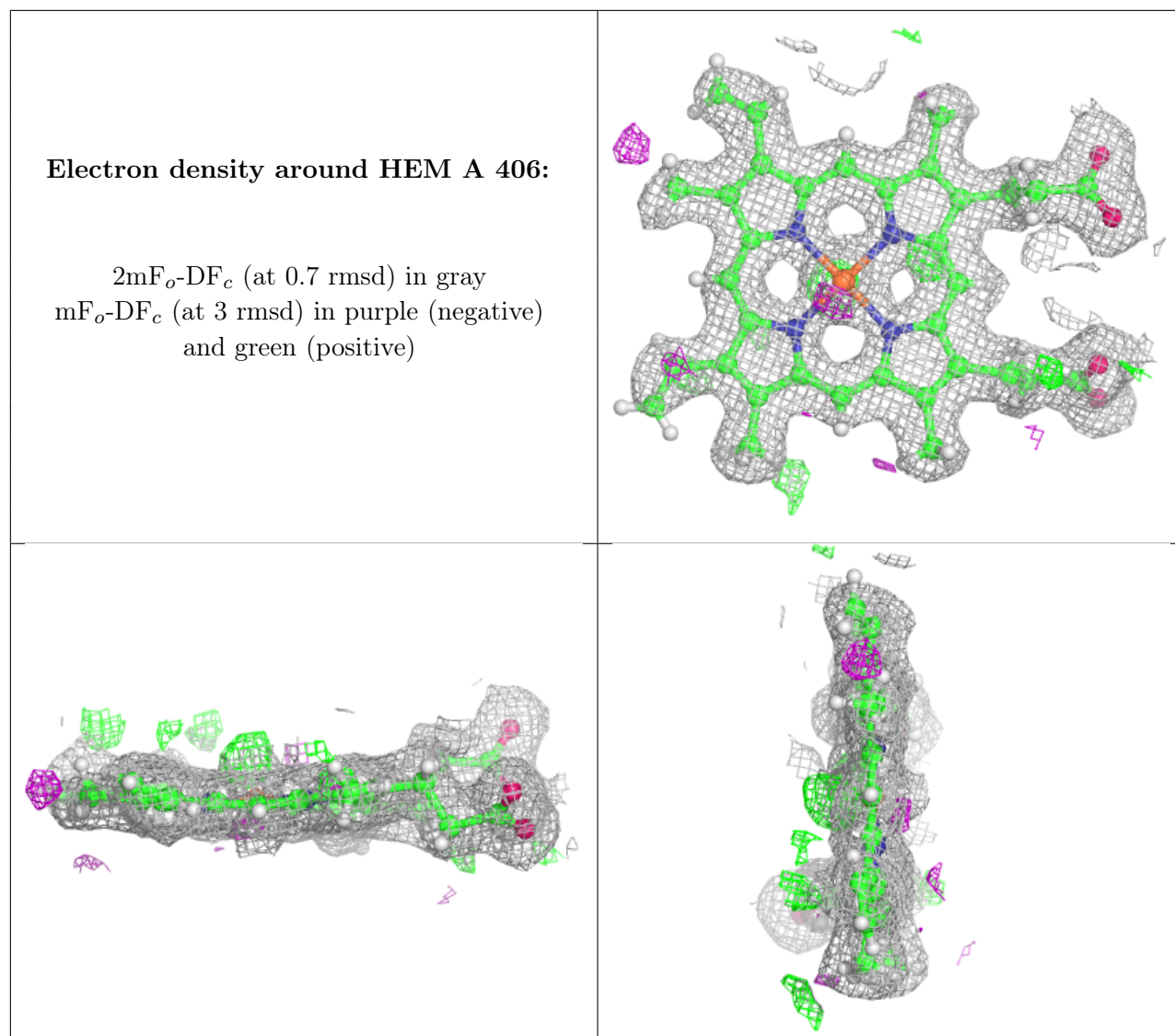

6.5 Other polymers [\(i\)](#)

There are no such residues in this entry.