



Full wwPDB X-ray Structure Validation Report ⓘ

May 13, 2020 – 02:39 am BST

PDB ID : 6O7A
Title : Crystal structure of the LjCASTOR gating ring in the Ca²⁺-free state
Authors : Jiang, Y.; Kim, S.
Deposited on : 2019-03-07
Resolution : 3.30 Å(reported)

This is a Full wwPDB X-ray Structure Validation Report for a publicly released PDB entry.

We welcome your comments at validation@mail.wwpdb.org

A user guide is available at

<https://www.wwpdb.org/validation/2017/XrayValidationReportHelp>

with specific help available everywhere you see the ⓘ symbol.

The following versions of software and data (see [references ⓘ](#)) were used in the production of this report:

MolProbity : 4.02b-467
Xtriage (Phenix) : 1.13
EDS : 2.11
Percentile statistics : 20191225.v01 (using entries in the PDB archive December 25th 2019)
Refmac : 5.8.0158
CCP4 : 7.0.044 (Gargrove)
Ideal geometry (proteins) : Engh & Huber (2001)
Ideal geometry (DNA, RNA) : Parkinson et al. (1996)
Validation Pipeline (wwPDB-VP) : 2.11

1 Overall quality at a glance

The following experimental techniques were used to determine the structure:

X-RAY DIFFRACTION

The reported resolution of this entry is 3.30 Å.

Percentile scores (ranging between 0-100) for global validation metrics of the entry are shown in the following graphic. The table shows the number of entries on which the scores are based.

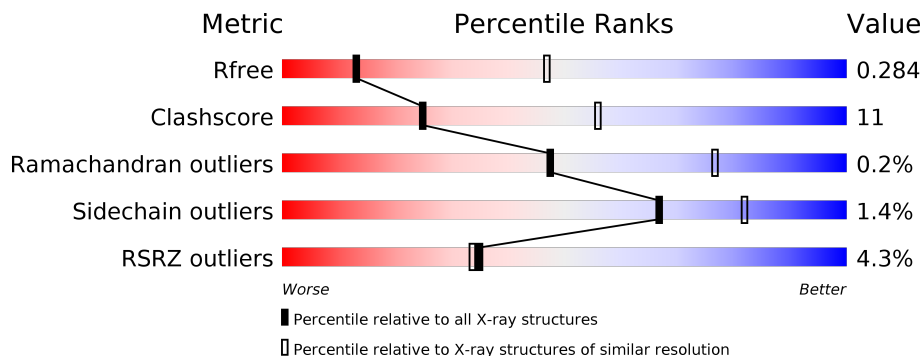

Metric	Whole archive (#Entries)	Similar resolution (#Entries, resolution range(Å))
R_{free}	130704	1149 (3.34-3.26)
Clashscore	141614	1205 (3.34-3.26)
Ramachandran outliers	138981	1183 (3.34-3.26)
Sidechain outliers	138945	1182 (3.34-3.26)
RSRZ outliers	127900	1115 (3.34-3.26)

The table below summarises the geometric issues observed across the polymeric chains and their fit to the electron density. The red, orange, yellow and green segments on the lower bar indicate the fraction of residues that contain outliers for ≥ 3 , 2, 1 and 0 types of geometric quality criteria respectively. A grey segment represents the fraction of residues that are not modelled. The numeric value for each fraction is indicated below the corresponding segment, with a dot representing fractions $\leq 5\%$. The upper red bar (where present) indicates the fraction of residues that have poor fit to the electron density. The numeric value is given above the bar.

Mol	Chain	Length	Quality of chain
1	A	554	
1	B	554	
1	C	554	
1	D	554	

2 Entry composition i

There is only 1 type of molecule in this entry. The entry contains 15882 atoms, of which 0 are hydrogens and 0 are deuteriums.

In the tables below, the ZeroOcc column contains the number of atoms modelled with zero occupancy, the AltConf column contains the number of residues with at least one atom in alternate conformation and the Trace column contains the number of residues modelled with at most 2 atoms.

- Molecule 1 is a protein called Ion channel CASTOR.

Mol	Chain	Residues	Atoms					ZeroOcc	AltConf	Trace
			Total	C	N	O	S			
1	A	506	3970	2504	681	764	21	0	0	0
1	C	506	3970	2504	681	764	21	0	0	0
1	B	505	3963	2499	680	763	21	0	0	0
1	D	507	3979	2509	682	767	21	0	0	0

There are 48 discrepancies between the modelled and reference sequences:

Chain	Residue	Modelled	Actual	Comment	Reference
A	310	MET	-	expression tag	UNP Q5H8A6
A	311	ALA	-	expression tag	UNP Q5H8A6
A	854	GLY	-	expression tag	UNP Q5H8A6
A	855	SER	-	expression tag	UNP Q5H8A6
A	856	ARG	-	expression tag	UNP Q5H8A6
A	857	SER	-	expression tag	UNP Q5H8A6
A	858	HIS	-	expression tag	UNP Q5H8A6
A	859	HIS	-	expression tag	UNP Q5H8A6
A	860	HIS	-	expression tag	UNP Q5H8A6
A	861	HIS	-	expression tag	UNP Q5H8A6
A	862	HIS	-	expression tag	UNP Q5H8A6
A	863	HIS	-	expression tag	UNP Q5H8A6
C	310	MET	-	expression tag	UNP Q5H8A6
C	311	ALA	-	expression tag	UNP Q5H8A6
C	854	GLY	-	expression tag	UNP Q5H8A6
C	855	SER	-	expression tag	UNP Q5H8A6
C	856	ARG	-	expression tag	UNP Q5H8A6
C	857	SER	-	expression tag	UNP Q5H8A6
C	858	HIS	-	expression tag	UNP Q5H8A6
C	859	HIS	-	expression tag	UNP Q5H8A6
C	860	HIS	-	expression tag	UNP Q5H8A6

Continued on next page...

Continued from previous page...

Chain	Residue	Modelled	Actual	Comment	Reference
C	861	HIS	-	expression tag	UNP Q5H8A6
C	862	HIS	-	expression tag	UNP Q5H8A6
C	863	HIS	-	expression tag	UNP Q5H8A6
B	310	MET	-	expression tag	UNP Q5H8A6
B	311	ALA	-	expression tag	UNP Q5H8A6
B	854	GLY	-	expression tag	UNP Q5H8A6
B	855	SER	-	expression tag	UNP Q5H8A6
B	856	ARG	-	expression tag	UNP Q5H8A6
B	857	SER	-	expression tag	UNP Q5H8A6
B	858	HIS	-	expression tag	UNP Q5H8A6
B	859	HIS	-	expression tag	UNP Q5H8A6
B	860	HIS	-	expression tag	UNP Q5H8A6
B	861	HIS	-	expression tag	UNP Q5H8A6
B	862	HIS	-	expression tag	UNP Q5H8A6
B	863	HIS	-	expression tag	UNP Q5H8A6
D	310	MET	-	expression tag	UNP Q5H8A6
D	311	ALA	-	expression tag	UNP Q5H8A6
D	854	GLY	-	expression tag	UNP Q5H8A6
D	855	SER	-	expression tag	UNP Q5H8A6
D	856	ARG	-	expression tag	UNP Q5H8A6
D	857	SER	-	expression tag	UNP Q5H8A6
D	858	HIS	-	expression tag	UNP Q5H8A6
D	859	HIS	-	expression tag	UNP Q5H8A6
D	860	HIS	-	expression tag	UNP Q5H8A6
D	861	HIS	-	expression tag	UNP Q5H8A6
D	862	HIS	-	expression tag	UNP Q5H8A6
D	863	HIS	-	expression tag	UNP Q5H8A6

3 Residue-property plots [i](#)

These plots are drawn for all protein, RNA and DNA chains in the entry. The first graphic for a chain summarises the proportions of the various outlier classes displayed in the second graphic. The second graphic shows the sequence view annotated by issues in geometry and electron density. Residues are color-coded according to the number of geometric quality criteria for which they contain at least one outlier: green = 0, yellow = 1, orange = 2 and red = 3 or more. A red dot above a residue indicates a poor fit to the electron density ($RSRZ > 2$). Stretches of 2 or more consecutive residues without any outlier are shown as a green connector. Residues present in the sample, but not in the model, are shown in grey.

• Molecule 1: Ion channel CASTOR

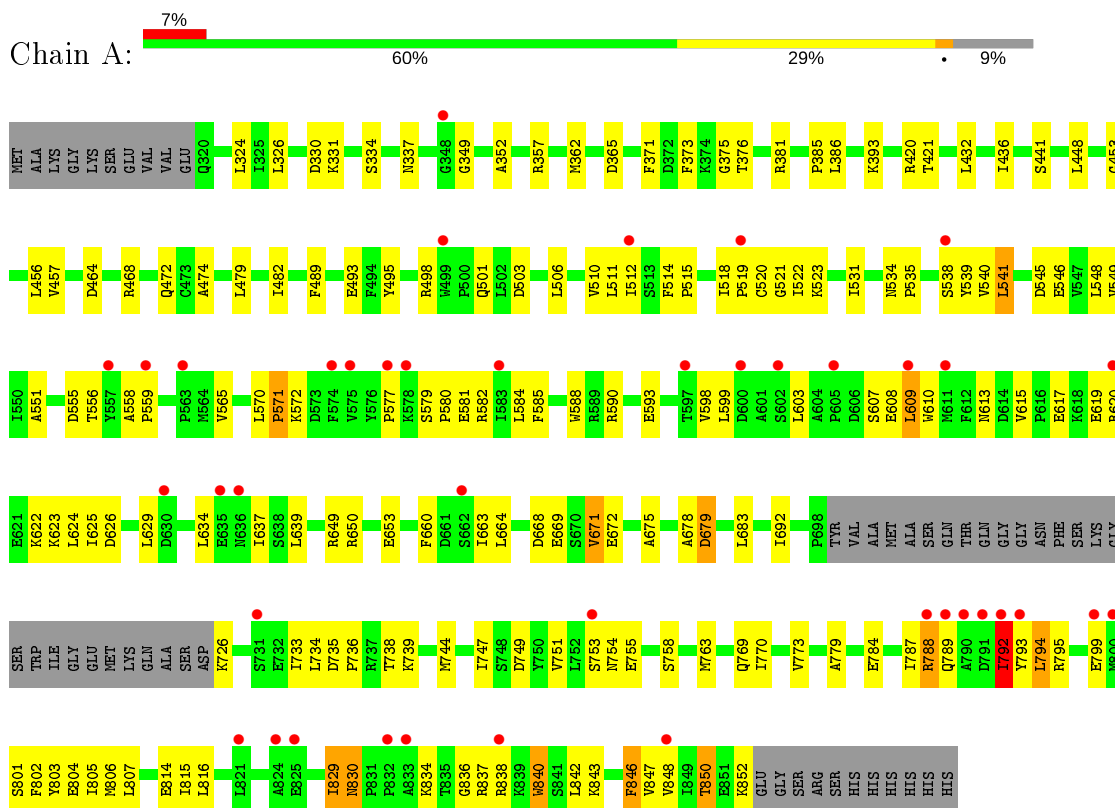

• Molecule 1: Ion channel CASTOR

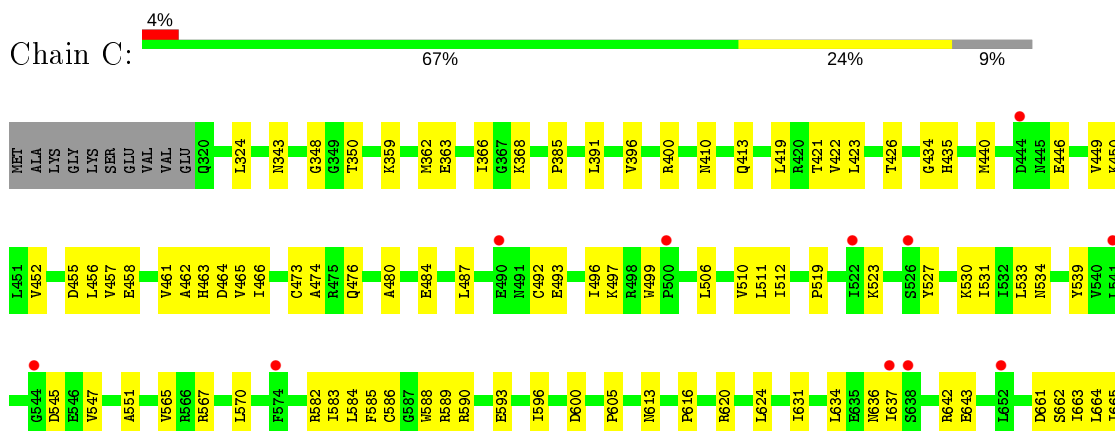

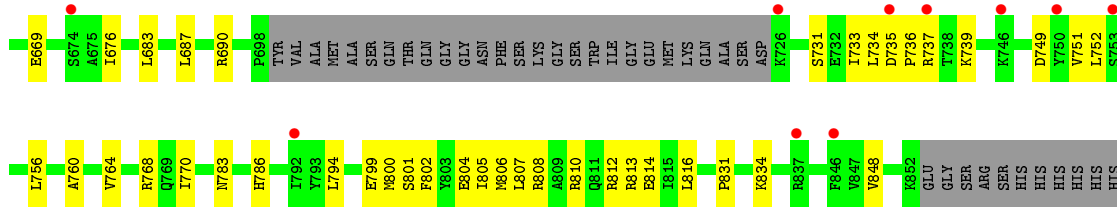

● Molecule 1: Ion channel CASTOR

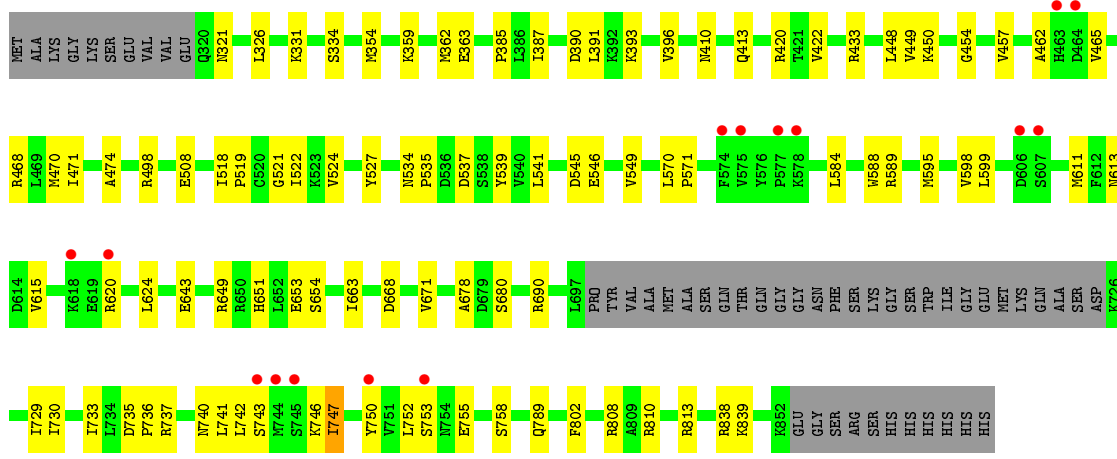
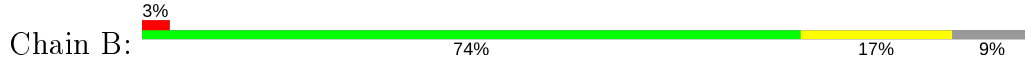

● Molecule 1: Ion channel CASTOR

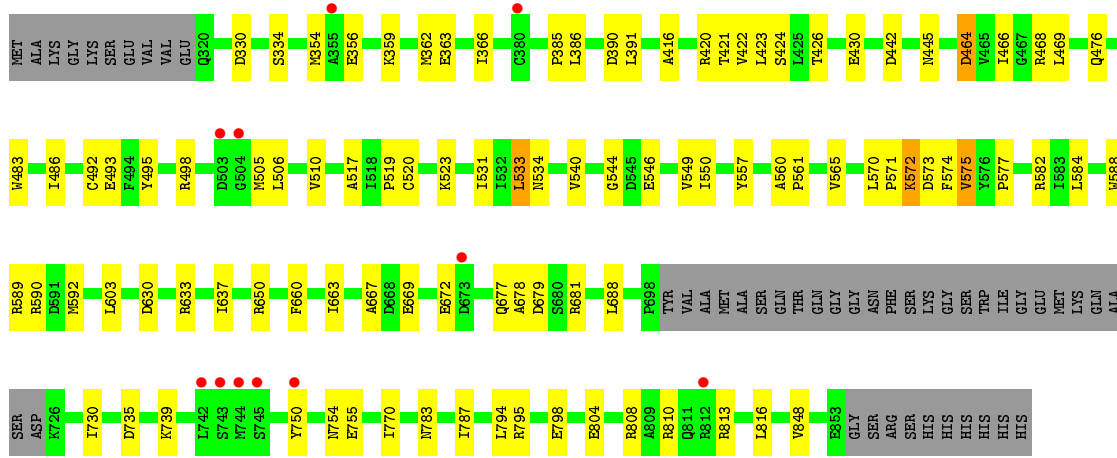

4 Data and refinement statistics

Property	Value	Source
Space group	P 1 21 1	Depositor
Cell constants a, b, c, α , β , γ	100.43Å 116.02Å 113.03Å 90.00° 113.92° 90.00°	Depositor
Resolution (Å)	41.47 – 3.30 41.46 – 3.30	Depositor EDS
% Data completeness (in resolution range)	99.8 (41.47-3.30) 94.6 (41.46-3.30)	Depositor EDS
R_{merge}	0.08	Depositor
R_{sym}	0.08	Depositor
$\langle I/\sigma(I) \rangle$ ¹	3.01 (at 3.32Å)	Xtrriage
Refinement program	PHENIX 1.13_2998	Depositor
R, R_{free}	0.229 , 0.284 0.229 , 0.284	Depositor DCC
R_{free} test set	1996 reflections (5.57%)	wwPDB-VP
Wilson B-factor (Å ²)	89.1	Xtrriage
Anisotropy	0.651	Xtrriage
Bulk solvent k_{sol} (e/Å ³), B_{sol} (Å ²)	0.29 , 62.3	EDS
L-test for twinning ²	$\langle L \rangle = 0.48$, $\langle L^2 \rangle = 0.32$	Xtrriage
Estimated twinning fraction	0.023 for h,-k,-h-l	Xtrriage
F_o, F_c correlation	0.93	EDS
Total number of atoms	15882	wwPDB-VP
Average B, all atoms (Å ²)	113.0	wwPDB-VP

Xtrriage's analysis on translational NCS is as follows: *The largest off-origin peak in the Patterson function is 3.75% of the height of the origin peak. No significant pseudotranslation is detected.*

¹Intensities estimated from amplitudes.

²Theoretical values of $\langle |L| \rangle$, $\langle L^2 \rangle$ for acentric reflections are 0.5, 0.333 respectively for untwinned datasets, and 0.375, 0.2 for perfectly twinned datasets.

5 Model quality [i](#)

5.1 Standard geometry [i](#)

The Z score for a bond length (or angle) is the number of standard deviations the observed value is removed from the expected value. A bond length (or angle) with $|Z| > 5$ is considered an outlier worth inspection. RMSZ is the root-mean-square of all Z scores of the bond lengths (or angles).

Mol	Chain	Bond lengths		Bond angles	
		RMSZ	# Z >5	RMSZ	# Z >5
1	A	0.33	0/4026	0.54	2/5440 (0.0%)
1	B	0.30	0/4018	0.51	0/5428
1	C	0.30	0/4026	0.50	0/5440
1	D	0.30	0/4035	0.49	0/5452
All	All	0.31	0/16105	0.51	2/21760 (0.0%)

Chiral center outliers are detected by calculating the chiral volume of a chiral center and verifying if the center is modelled as a planar moiety or with the opposite hand. A planarity outlier is detected by checking planarity of atoms in a peptide group, atoms in a mainchain group or atoms of a sidechain that are expected to be planar.

Mol	Chain	#Chirality outliers	#Planarity outliers
1	A	0	3

There are no bond length outliers.

All (2) bond angle outliers are listed below:

Mol	Chain	Res	Type	Atoms	Z	Observed($^{\circ}$)	Ideal($^{\circ}$)
1	A	794	LEU	CA-CB-CG	-7.50	98.04	115.30
1	A	541	LEU	CB-CG-CD2	-5.31	101.97	111.00

There are no chirality outliers.

All (3) planarity outliers are listed below:

Mol	Chain	Res	Type	Group
1	A	571	PRO	Peptide
1	A	792	ILE	Peptide
1	A	843	LYS	Peptide

5.2 Too-close contacts [i](#)

In the following table, the Non-H and H(model) columns list the number of non-hydrogen atoms and hydrogen atoms in the chain respectively. The H(added) column lists the number of hydrogen atoms added and optimized by MolProbity. The Clashes column lists the number of clashes within the asymmetric unit, whereas Symm-Clashes lists symmetry related clashes.

Mol	Chain	Non-H	H(model)	H(added)	Clashes	Symm-Clashes
1	A	3970	0	4033	130	1
1	B	3963	0	4026	68	0
1	C	3970	0	4033	93	1
1	D	3979	0	4039	66	0
All	All	15882	0	16131	347	1

The all-atom clashscore is defined as the number of clashes found per 1000 atoms (including hydrogen atoms). The all-atom clashscore for this structure is 11.

All (347) close contacts within the same asymmetric unit are listed below, sorted by their clash magnitude.

Atom-1	Atom-2	Interatomic distance (Å)	Clash overlap (Å)
1:C:805:ILE:HG23	1:C:808:ARG:HH21	1.45	0.82
1:C:794:LEU:HB3	1:C:808:ARG:HH12	1.46	0.80
1:A:739:LYS:HD2	1:A:753:SER:HB3	1.64	0.79
1:B:470:MET:HG2	1:B:752:LEU:HD21	1.66	0.78
1:B:534:ASN:O	1:B:813:ARG:NH2	2.17	0.77
1:B:611:MET:SD	1:B:620:ARG:NH2	2.59	0.76
1:A:581:GLU:HG3	1:A:603:LEU:HD11	1.68	0.75
1:A:683:LEU:HD21	1:A:733:ILE:HD11	1.68	0.74
1:D:498:ARG:HH21	1:D:544:GLY:H	1.36	0.73
1:B:390:ASP:HA	1:B:393:LYS:HE3	1.71	0.72
1:A:787:ILE:HG22	1:A:847:VAL:HA	1.71	0.72
1:D:498:ARG:HB2	1:D:546:GLU:HG2	1.70	0.72
1:C:463:HIS:HE1	1:C:590:ARG:HB3	1.54	0.72
1:A:330:ASP:HB3	1:A:736:PRO:HD3	1.72	0.72
1:A:629:LEU:HD11	1:A:634:LEU:HD21	1.73	0.69
1:A:736:PRO:HA	1:A:739:LYS:HD3	1.73	0.69
1:D:523:LYS:HA	1:D:531:ILE:HG22	1.73	0.69
1:A:650:ARG:HA	1:A:653:GLU:HG3	1.75	0.69
1:B:649:ARG:NH1	1:B:653:GLU:OE1	2.26	0.69
1:D:565:VAL:HG13	1:D:804:GLU:HG2	1.75	0.68
1:C:593:GLU:HG3	1:C:624:LEU:HD12	1.76	0.68
1:C:456:LEU:HD22	1:C:768:ARG:HH12	1.59	0.67
1:A:511:LEU:HA	1:A:519:PRO:HG2	1.77	0.67

Continued on next page...

Continued from previous page...

Atom-1	Atom-2	Interatomic distance (Å)	Clash overlap (Å)
1:A:571:PRO:HG3	1:A:795:ARG:HD3	1.76	0.67
1:B:730:ILE:HA	1:B:750:TYR:O	1.94	0.67
1:A:565:VAL:HG21	1:A:807:LEU:HD13	1.76	0.67
1:C:816:LEU:HA	1:C:848:VAL:HG12	1.76	0.66
1:A:386:LEU:HD22	1:A:420:ARG:HG3	1.78	0.66
1:D:359:LYS:NZ	1:D:363:GLU:OE2	2.29	0.66
1:A:805:ILE:HG21	1:A:846:PHE:CZ	2.31	0.66
1:B:680:SER:HB3	1:D:416:ALA:HB1	1.78	0.66
1:C:570:LEU:HD12	1:C:808:ARG:HH11	1.61	0.65
1:A:770:ILE:O	1:A:773:VAL:HG12	1.97	0.65
1:A:733:ILE:HD12	1:A:751:VAL:HG11	1.78	0.65
1:B:539:TYR:OH	1:B:545:ASP:OD2	2.14	0.65
1:A:326:LEU:HD13	1:A:385:PRO:HB3	1.78	0.64
1:D:816:LEU:HA	1:D:848:VAL:HG12	1.79	0.64
1:A:489:PHE:HE2	1:A:763:MET:HG2	1.60	0.64
1:C:800:MET:SD	1:C:808:ARG:NH1	2.70	0.64
1:D:533:LEU:HD11	1:D:783:ASN:HB2	1.79	0.63
1:C:410:ASN:HB3	1:C:413:GLN:HB2	1.79	0.63
1:A:565:VAL:HB	1:A:804:GLU:HG2	1.81	0.62
1:B:519:PRO:HA	1:B:549:VAL:HG12	1.80	0.62
1:C:511:LEU:HD12	1:C:512:ILE:HG23	1.81	0.62
1:A:794:LEU:HD11	1:A:846:PHE:CZ	2.35	0.62
1:A:801:SER:HB2	1:A:836:GLY:HA2	1.81	0.61
1:C:492:CYS:HA	1:C:551:ALA:O	2.00	0.61
1:B:508:GLU:HB3	1:B:537:ASP:HB3	1.81	0.61
1:A:498:ARG:HB2	1:A:546:GLU:HG2	1.82	0.61
1:A:584:LEU:HD12	1:A:663:ILE:HG23	1.82	0.61
1:B:410:ASN:HB3	1:B:413:GLN:HB2	1.82	0.61
1:C:462:ALA:O	1:C:465:VAL:HG12	2.01	0.61
1:B:422:VAL:HG21	1:B:449:VAL:HG13	1.84	0.60
1:C:435:HIS:HB3	1:C:768:ARG:HH11	1.65	0.60
1:B:736:PRO:HG3	1:B:755:GLU:HG3	1.83	0.59
1:C:585:PHE:HE1	1:C:664:LEU:HD12	1.68	0.59
1:A:571:PRO:HG2	1:A:792:ILE:HG22	1.84	0.59
1:C:812:ARG:HB3	1:C:814:GLU:HG3	1.85	0.58
1:A:588:TRP:NE1	1:A:669:GLU:OE2	2.31	0.58
1:A:511:LEU:HD12	1:A:512:ILE:HG23	1.85	0.58
1:A:639:LEU:HD23	1:A:639:LEU:H	1.69	0.58
1:C:487:LEU:HD12	1:C:756:LEU:HD12	1.85	0.58
1:A:590:ARG:HA	1:A:669:GLU:HG2	1.85	0.58
1:C:570:LEU:HB2	1:C:808:ARG:HD2	1.86	0.58

Continued on next page...

Continued from previous page...

Atom-1	Atom-2	Interatomic distance (Å)	Clash overlap (Å)
1:A:834:LYS:HD3	1:A:837:ARG:HD3	1.85	0.57
1:A:514:PHE:O	1:A:803:TYR:OH	2.22	0.57
1:B:741:LEU:HB3	1:D:423:LEU:HG	1.86	0.57
1:A:420:ARG:HD3	1:D:739:LYS:HE3	1.87	0.57
1:A:534:ASN:HA	1:A:815:ILE:HD11	1.86	0.57
1:C:539:TYR:OH	1:C:545:ASP:OD2	2.21	0.57
1:A:531:ILE:HD11	1:A:769:GLN:HB3	1.86	0.57
1:A:829:ILE:HG23	1:A:830:ASN:OD1	2.05	0.57
1:A:837:ARG:HE	1:A:838:ARG:H	1.53	0.57
1:A:518:ILE:HB	1:A:830:ASN:ND2	2.20	0.56
1:A:432:LEU:HD12	1:A:456:LEU:HD13	1.87	0.56
1:A:373:PHE:HB3	1:A:376:THR:HB	1.87	0.56
1:A:649:ARG:HH21	1:A:692:ILE:HD11	1.69	0.56
1:A:622:LYS:HA	1:A:625:ILE:HG22	1.88	0.56
1:B:620:ARG:NH2	1:B:624:LEU:HD11	2.21	0.56
1:A:787:ILE:O	1:A:788:ARG:HG2	2.06	0.56
1:A:675:ALA:HB1	1:A:735:ASP:OD2	2.05	0.56
1:A:514:PHE:HE2	1:A:559:PRO:HB3	1.70	0.56
1:A:381:ARG:HH11	1:A:393:LYS:HE2	1.70	0.55
1:D:735:ASP:O	1:D:739:LYS:HG2	2.07	0.55
1:D:590:ARG:HH21	1:D:672:GLU:HG2	1.71	0.55
1:A:579:SER:HB3	1:A:603:LEU:HD22	1.88	0.55
1:B:651:HIS:O	1:B:654:SER:OG	2.17	0.54
1:C:605:PRO:HA	1:C:636:ASN:HB3	1.87	0.54
1:B:741:LEU:HD22	1:D:424:SER:HA	1.87	0.54
1:A:588:TRP:HZ2	1:A:623:LYS:HD2	1.72	0.54
1:A:581:GLU:CG	1:A:603:LEU:HD11	2.37	0.54
1:A:830:ASN:N	1:A:830:ASN:OD1	2.40	0.54
1:C:385:PRO:HB2	1:C:421:THR:HG23	1.90	0.54
1:C:567:ARG:HD3	1:C:807:LEU:HD13	1.90	0.54
1:D:386:LEU:HD22	1:D:420:ARG:HG3	1.90	0.54
1:D:534:ASN:HD22	1:D:783:ASN:ND2	2.06	0.54
1:C:596:ILE:HD12	1:C:624:LEU:HD11	1.90	0.53
1:B:450:LYS:O	1:B:454:GLY:N	2.29	0.53
1:C:474:ALA:HB2	1:C:664:LEU:HD21	1.89	0.53
1:D:523:LYS:HB3	1:D:546:GLU:HB2	1.89	0.53
1:A:541:LEU:HB3	1:A:545:ASP:OD2	2.08	0.53
1:A:814:GLU:HB3	1:A:848:VAL:HG11	1.91	0.53
1:C:794:LEU:HD23	1:C:808:ARG:HH22	1.73	0.53
1:A:441:SER:O	1:A:590:ARG:NH2	2.31	0.53
1:D:735:ASP:HB3	1:D:739:LYS:HZ3	1.74	0.53

Continued on next page...

Continued from previous page...

Atom-1	Atom-2	Interatomic distance (Å)	Clash overlap (Å)
1:D:466:ILE:HD11	1:D:754:ASN:HA	1.91	0.53
1:C:620:ARG:NH2	1:C:642:ARG:O	2.38	0.53
1:D:603:LEU:HB2	1:D:637:ILE:HD11	1.91	0.53
1:D:334:SER:OG	1:D:755:GLU:HG3	2.08	0.53
1:B:354:MET:SD	1:B:390:ASP:HB3	2.48	0.53
1:C:497:LYS:HD3	1:C:499:TRP:CZ2	2.44	0.53
1:C:805:ILE:HG23	1:C:808:ARG:NH2	2.21	0.52
1:D:575:VAL:O	1:D:577:PRO:HD3	2.08	0.52
1:B:740:ASN:O	1:B:743:SER:OG	2.26	0.52
1:C:565:VAL:HG13	1:C:804:GLU:HG2	1.92	0.52
1:D:430:GLU:N	1:D:430:GLU:OE1	2.43	0.52
1:C:368:LYS:HB3	1:B:387:ILE:HG21	1.92	0.51
1:C:687:LEU:HB3	1:B:448:LEU:HD22	1.92	0.51
1:A:805:ILE:HG21	1:A:846:PHE:CE1	2.45	0.51
1:A:620:ARG:HA	1:A:623:LYS:HG3	1.93	0.51
1:C:493:GLU:N	1:C:493:GLU:OE1	2.41	0.51
1:C:620:ARG:HH22	1:C:642:ARG:C	2.14	0.51
1:B:838:ARG:NH1	1:B:839:LYS:O	2.44	0.51
1:C:506:LEU:O	1:C:510:VAL:HG23	2.11	0.51
1:A:726:LYS:HD2	1:A:747:ILE:HG21	1.92	0.51
1:A:585:PHE:HE2	1:A:609:LEU:HG	1.75	0.51
1:C:586:CYS:HB2	1:C:665:ILE:HA	1.92	0.51
1:A:579:SER:HB3	1:A:603:LEU:HD13	1.93	0.51
1:A:619:GLU:OE2	1:A:623:LYS:HE2	2.12	0.50
1:A:474:ALA:HB2	1:A:664:LEU:HD21	1.93	0.50
1:D:506:LEU:HD23	1:D:540:VAL:HG22	1.94	0.50
1:D:798:GLU:OE2	1:D:808:ARG:NH2	2.43	0.50
1:B:471:ILE:HD13	1:B:599:LEU:HB2	1.94	0.50
1:D:385:PRO:HB2	1:D:421:THR:HG23	1.93	0.50
1:D:667:ALA:HB1	1:D:678:ALA:HB1	1.94	0.50
1:D:534:ASN:O	1:D:813:ARG:NH2	2.44	0.50
1:C:423:LEU:O	1:C:426:THR:OG1	2.25	0.50
1:C:794:LEU:HB3	1:C:808:ARG:NH1	2.22	0.50
1:B:570:LEU:HB2	1:B:808:ARG:HH12	1.76	0.50
1:B:649:ARG:O	1:B:653:GLU:HG3	2.12	0.50
1:A:834:LYS:HB3	1:A:837:ARG:HG2	1.94	0.49
1:B:735:ASP:OD1	1:B:737:ARG:HB3	2.12	0.49
1:B:690:ARG:CZ	1:B:729:ILE:HD12	2.42	0.49
1:B:742:LEU:HD11	1:B:746:LYS:CB	2.43	0.49
1:D:506:LEU:O	1:D:510:VAL:HG23	2.12	0.49
1:A:464:ASP:OD2	1:A:468:ARG:NH2	2.42	0.49

Continued on next page...

Continued from previous page...

Atom-1	Atom-2	Interatomic distance (Å)	Clash overlap (Å)
1:A:570:LEU:O	1:A:572:LYS:HG3	2.12	0.49
1:A:629:LEU:HD21	1:A:634:LEU:HD11	1.95	0.49
1:A:733:ILE:HD13	1:A:738:THR:HG22	1.95	0.49
1:D:572:LYS:HD3	1:D:574:PHE:CZ	2.47	0.49
1:A:671:VAL:O	1:A:678:ALA:HB2	2.12	0.49
1:B:331:LYS:HB3	1:B:758:SER:OG	2.12	0.49
1:C:511:LEU:HA	1:C:519:PRO:HG2	1.93	0.49
1:C:466:ILE:CG2	1:C:589:ARG:HH12	2.26	0.49
1:B:449:VAL:HG12	1:B:457:VAL:HG11	1.94	0.48
1:C:676:ILE:HA	1:C:735:ASP:OD2	2.12	0.48
1:C:527:TYR:HB3	1:C:530:LYS:HE3	1.96	0.48
1:A:816:LEU:HG	1:A:848:VAL:HG22	1.94	0.48
1:A:506:LEU:O	1:A:510:VAL:HG23	2.14	0.48
1:A:514:PHE:CD2	1:A:558:ALA:HB1	2.49	0.48
1:A:590:ARG:HA	1:A:669:GLU:CG	2.43	0.48
1:C:737:ARG:CZ	1:B:420:ARG:HD3	2.44	0.48
1:C:736:PRO:O	1:C:739:LYS:HB3	2.14	0.48
1:D:630:ASP:HB3	1:D:633:ARG:HD2	1.96	0.47
1:C:466:ILE:HG21	1:C:589:ARG:HH12	1.79	0.47
1:A:472:GLN:HB3	1:A:479:LEU:HD23	1.96	0.47
1:A:551:ALA:HB1	1:A:556:THR:HG21	1.95	0.47
1:A:799:GLU:HA	1:A:840:TRP:HE1	1.79	0.47
1:C:749:ASP:O	1:C:751:VAL:HG22	2.14	0.47
1:A:514:PHE:CE2	1:A:559:PRO:HB3	2.49	0.47
1:C:476:GLN:HE22	1:C:786:HIS:CD2	2.32	0.47
1:D:498:ARG:NH2	1:D:544:GLY:H	2.10	0.47
1:C:458:GLU:HG3	1:C:768:ARG:HG3	1.97	0.47
1:C:802:PHE:HB3	1:C:834:LYS:HA	1.97	0.47
1:A:582:ARG:HG3	1:A:608:GLU:HB2	1.97	0.47
1:B:391:LEU:HB3	1:B:396:VAL:HG11	1.97	0.47
1:A:365:ASP:OD1	1:A:365:ASP:N	2.48	0.46
1:A:585:PHE:HZ	1:A:599:LEU:HD13	1.80	0.46
1:B:733:ILE:O	1:B:753:SER:HA	2.14	0.46
1:C:582:ARG:O	1:C:661:ASP:N	2.48	0.46
1:A:816:LEU:HD12	1:A:848:VAL:HG13	1.97	0.46
1:C:731:SER:OG	1:C:751:VAL:HG11	2.16	0.46
1:A:521:GLY:HA3	1:A:548:LEU:HD23	1.98	0.46
1:C:533:LEU:HD23	1:C:783:ASN:HB2	1.98	0.46
1:A:555:ASP:N	1:A:555:ASP:OD1	2.48	0.46
1:C:446:GLU:OE2	1:C:450:LYS:HD2	2.14	0.46
1:A:739:LYS:NZ	1:A:755:GLU:HB2	2.30	0.46

Continued on next page...

Continued from previous page...

Atom-1	Atom-2	Interatomic distance (Å)	Clash overlap (Å)
1:B:522:ILE:HG12	1:B:535:PRO:HG3	1.98	0.46
1:B:539:TYR:HE2	1:B:541:LEU:HA	1.80	0.46
1:B:584:LEU:HD23	1:B:663:ILE:HG23	1.96	0.46
1:B:733:ILE:HG13	1:B:753:SER:HB3	1.97	0.46
1:A:523:LYS:HG2	1:A:531:ILE:HG12	1.98	0.46
1:B:498:ARG:HB2	1:B:546:GLU:HG2	1.98	0.46
1:C:466:ILE:HG22	1:C:589:ARG:HH22	1.79	0.46
1:A:506:LEU:HD12	1:A:538:SER:HA	1.97	0.46
1:D:735:ASP:HB3	1:D:739:LYS:NZ	2.31	0.46
1:A:337:ASN:HB2	1:A:371:PHE:CE1	2.51	0.46
1:B:321:ASN:HB3	1:B:433:ARG:HH11	1.81	0.46
1:D:549:VAL:HG11	1:D:557:TYR:CE2	2.51	0.46
1:A:518:ILE:HB	1:A:830:ASN:HD22	1.80	0.45
1:D:589:ARG:H	1:D:592:MET:HE3	1.81	0.45
1:D:571:PRO:HG3	1:D:794:LEU:N	2.30	0.45
1:B:524:VAL:HB	1:B:527:TYR:HB2	1.98	0.45
1:C:731:SER:H	1:C:751:VAL:HG12	1.80	0.45
1:D:483:TRP:HA	1:D:486:ILE:HG22	1.98	0.45
1:D:588:TRP:HA	1:D:592:MET:HE1	1.98	0.45
1:A:334:SER:HB2	1:A:755:GLU:HG3	1.98	0.45
1:A:324:LEU:HD12	1:A:352:ALA:O	2.17	0.45
1:A:514:PHE:HB2	1:A:519:PRO:HD3	1.99	0.45
1:A:468:ARG:HG3	1:A:598:VAL:HG11	1.98	0.45
1:C:362:MET:O	1:C:366:ILE:HG12	2.16	0.45
1:C:511:LEU:HD13	1:C:806:MET:SD	2.56	0.45
1:D:469:LEU:HD11	1:D:483:TRP:CD1	2.52	0.45
1:A:585:PHE:HZ	1:A:599:LEU:CD1	2.30	0.45
1:A:744:MET:SD	1:A:749:ASP:HB3	2.57	0.45
1:A:789:GLN:HB3	1:A:793:TYR:OH	2.16	0.45
1:D:570:LEU:HA	1:D:570:LEU:HD23	1.82	0.45
1:C:731:SER:O	1:C:751:VAL:HB	2.16	0.45
1:C:801:SER:O	1:C:805:ILE:HG13	2.16	0.45
1:D:590:ARG:HG3	1:D:669:GLU:HB2	1.98	0.45
1:C:523:LYS:HB2	1:C:531:ILE:HG12	1.97	0.45
1:C:584:LEU:HD23	1:C:663:ILE:HG23	1.99	0.45
1:A:522:ILE:CG2	1:A:541:LEU:HD21	2.47	0.45
1:B:321:ASN:OD1	1:B:321:ASN:N	2.46	0.45
1:A:733:ILE:HB	1:A:751:VAL:CG1	2.47	0.44
1:D:520:CYS:SG	1:D:550:ILE:HG13	2.57	0.44
1:A:468:ARG:HD3	1:A:779:ALA:HA	1.99	0.44
1:B:588:TRP:O	1:B:668:ASP:HA	2.17	0.44

Continued on next page...

Continued from previous page...

Atom-1	Atom-2	Interatomic distance (Å)	Clash overlap (Å)
1:D:730:ILE:HG23	1:D:750:TYR:O	2.17	0.44
1:A:501:GLN:N	1:A:501:GLN:OE1	2.50	0.44
1:B:521:GLY:HA2	1:B:535:PRO:HD3	2.00	0.44
1:B:613:ASN:HD22	1:B:615:VAL:HB	1.83	0.44
1:B:789:GLN:H	1:B:789:GLN:HG2	1.60	0.44
1:A:837:ARG:HD2	1:A:837:ARG:HA	1.72	0.44
1:C:600:ASP:OD1	1:C:637:ILE:HD12	2.17	0.44
1:C:613:ASN:O	1:C:643:GLU:HA	2.16	0.44
1:A:453:GLY:HA3	1:A:457:VAL:HG21	2.00	0.44
1:A:522:ILE:HD12	1:A:535:PRO:HG3	2.00	0.44
1:A:506:LEU:HA	1:A:540:VAL:HG12	2.00	0.44
1:A:482:ILE:HG23	1:A:829:ILE:HD11	1.99	0.44
1:B:810:ARG:HA	1:B:810:ARG:HD2	1.73	0.44
1:B:539:TYR:CE2	1:B:541:LEU:HA	2.52	0.44
1:A:493:GLU:OE2	1:A:495:TYR:OH	2.25	0.44
1:A:784:GLU:OE2	1:A:852:LYS:HB2	2.16	0.44
1:D:510:VAL:O	1:D:519:PRO:HG2	2.18	0.44
1:A:371:PHE:CE1	1:A:373:PHE:HE1	2.36	0.44
1:A:609:LEU:HD13	1:A:637:ILE:HD12	1.99	0.44
1:D:810:ARG:HA	1:D:810:ARG:HD2	1.73	0.44
1:D:354:MET:SD	1:D:390:ASP:HB3	2.58	0.44
1:C:735:ASP:HB3	1:C:737:ARG:H	1.83	0.43
1:C:534:ASN:ND2	1:C:813:ARG:O	2.30	0.43
1:A:679:ASP:OD1	1:A:733:ILE:HG12	2.18	0.43
1:A:788:ARG:HG3	1:A:788:ARG:O	2.18	0.43
1:C:760:ALA:O	1:C:764:VAL:HG23	2.18	0.43
1:A:349:GLY:N	1:A:375:GLY:O	2.50	0.43
1:B:690:ARG:HA	1:B:690:ARG:HD3	1.85	0.43
1:D:571:PRO:HB2	1:D:572:LYS:HG2	2.01	0.43
1:D:582:ARG:HG2	1:D:660:PHE:HD1	1.82	0.43
1:A:588:TRP:CZ2	1:A:623:LYS:HD2	2.52	0.43
1:C:419:LEU:HD11	1:C:452:VAL:HG21	2.00	0.43
1:D:464:ASP:O	1:D:468:ARG:HG3	2.18	0.43
1:A:385:PRO:HB2	1:A:421:THR:HG22	2.01	0.43
1:A:739:LYS:HZ1	1:A:755:GLU:HB2	1.82	0.43
1:B:570:LEU:N	1:B:571:PRO:CD	2.81	0.43
1:C:768:ARG:O	1:C:770:ILE:N	2.52	0.43
1:A:626:ASP:O	1:D:650:ARG:HB3	2.19	0.43
1:A:668:ASP:O	1:A:672:GLU:HB2	2.19	0.43
1:A:734:LEU:O	1:A:754:ASN:ND2	2.52	0.43
1:B:518:ILE:HD11	1:B:802:PHE:HE2	1.84	0.43

Continued on next page...

Continued from previous page...

Atom-1	Atom-2	Interatomic distance (Å)	Clash overlap (Å)
1:C:806:MET:O	1:C:810:ARG:HG2	2.18	0.43
1:D:584:LEU:HD23	1:D:663:ILE:HG23	1.99	0.43
1:D:770:ILE:HA	1:D:770:ILE:HD12	1.84	0.43
1:B:589:ARG:HD3	1:B:595:MET:SD	2.59	0.43
1:C:631:ILE:O	1:C:634:LEU:HD23	2.19	0.43
1:C:687:LEU:HA	1:C:690:ARG:HG2	1.99	0.43
1:C:422:VAL:O	1:C:426:THR:HG23	2.19	0.42
1:D:517:ALA:HB1	1:D:549:VAL:CG2	2.48	0.42
1:A:806:MET:HG2	1:A:816:LEU:HB2	2.01	0.42
1:B:747:ILE:HG22	1:B:747:ILE:O	2.19	0.42
1:C:343:ASN:HB3	1:C:348:GLY:O	2.20	0.42
1:B:359:LYS:O	1:B:363:GLU:HG3	2.19	0.42
1:B:671:VAL:O	1:B:678:ALA:HB2	2.18	0.42
1:A:668:ASP:OD1	1:A:668:ASP:N	2.44	0.42
1:C:391:LEU:HD22	1:C:396:VAL:HG21	2.01	0.42
1:D:442:ASP:HB3	1:D:445:ASN:OD1	2.19	0.42
1:A:794:LEU:CD2	1:A:840:TRP:HH2	2.32	0.42
1:C:461:VAL:HG22	1:C:464:ASP:HB3	2.01	0.42
1:C:802:PHE:CE1	1:C:831:PRO:HG2	2.54	0.42
1:A:520:CYS:HB3	1:A:815:ILE:HG21	2.02	0.42
1:B:321:ASN:HB3	1:B:433:ARG:NH1	2.35	0.42
1:B:742:LEU:HD11	1:B:746:LYS:HB3	2.01	0.42
1:C:440:MET:SD	1:C:449:VAL:HG21	2.59	0.42
1:C:613:ASN:O	1:C:620:ARG:NH2	2.52	0.42
1:D:589:ARG:H	1:D:592:MET:CE	2.32	0.42
1:B:326:LEU:HD13	1:B:385:PRO:HB3	2.02	0.42
1:B:462:ALA:HA	1:B:465:VAL:HG22	2.01	0.42
1:B:742:LEU:HD11	1:B:746:LYS:HB2	2.01	0.42
1:D:677:GLN:O	1:D:681:ARG:HG3	2.20	0.42
1:A:840:TRP:CD1	1:A:840:TRP:N	2.86	0.42
1:D:362:MET:O	1:D:366:ILE:HG12	2.20	0.42
1:A:794:LEU:HA	1:A:794:LEU:HD23	1.72	0.42
1:A:814:GLU:HB3	1:A:848:VAL:CG1	2.49	0.42
1:C:359:LYS:HE2	1:C:363:GLU:OE2	2.19	0.42
1:D:422:VAL:O	1:D:426:THR:HG23	2.18	0.42
1:C:480:ALA:O	1:C:484:GLU:HG3	2.20	0.42
1:D:330:ASP:OD2	1:D:330:ASP:N	2.50	0.42
1:D:385:PRO:HA	1:D:391:LEU:HD21	2.02	0.42
1:C:400:ARG:O	1:C:434:GLY:HA3	2.20	0.41
1:D:560:ALA:HB1	1:D:561:PRO:HD2	2.02	0.41
1:C:616:PRO:O	1:C:620:ARG:HG3	2.19	0.41

Continued on next page...

Continued from previous page...

Atom-1	Atom-2	Interatomic distance (Å)	Clash overlap (Å)
1:A:649:ARG:HH21	1:A:692:ILE:CD1	2.32	0.41
1:B:613:ASN:O	1:B:643:GLU:HA	2.21	0.41
1:B:334:SER:CB	1:B:755:GLU:HG2	2.49	0.41
1:C:583:ILE:HG23	1:C:662:SER:OG	2.20	0.41
1:C:737:ARG:NH2	1:B:420:ARG:HD3	2.35	0.41
1:D:493:GLU:HB2	1:D:495:TYR:CE2	2.55	0.41
1:A:436:ILE:N	1:A:456:LEU:O	2.52	0.41
1:B:468:ARG:HG2	1:B:598:VAL:HG21	2.02	0.41
1:B:474:ALA:N	1:B:730:ILE:HD11	2.36	0.41
1:B:570:LEU:H	1:B:808:ARG:NH1	2.19	0.41
1:C:683:LEU:HD22	1:C:737:ARG:HD3	2.03	0.41
1:A:519:PRO:HB3	1:A:549:VAL:HG12	2.02	0.41
1:C:324:LEU:CD2	1:C:396:VAL:HG22	2.51	0.41
1:C:733:ILE:HD13	1:C:751:VAL:HG23	2.02	0.41
1:C:800:MET:HE3	1:C:800:MET:HB2	1.76	0.41
1:A:814:GLU:HG2	1:A:850:THR:HB	2.02	0.41
1:C:496:ILE:HA	1:C:547:VAL:O	2.21	0.41
1:A:585:PHE:HE2	1:A:609:LEU:CG	2.34	0.41
1:C:588:TRP:HB2	1:C:613:ASN:HB3	2.03	0.41
1:D:505:MET:HB3	1:D:505:MET:HE3	1.93	0.41
1:D:679:ASP:CG	1:D:739:LYS:HE2	2.41	0.41
1:A:613:ASN:HB3	1:A:615:VAL:HG12	2.03	0.41
1:A:448:LEU:HD21	1:D:688:LEU:HD23	2.03	0.40
1:D:476:GLN:HB2	1:D:787:ILE:HB	2.03	0.40
1:A:331:LYS:HB3	1:A:758:SER:OG	2.20	0.40
1:C:620:ARG:HH12	1:C:642:ARG:H	1.67	0.40
1:B:359:LYS:HA	1:B:362:MET:HE2	2.03	0.40
1:A:357:ARG:NH1	1:A:362:MET:HG2	2.36	0.40
1:A:624:LEU:HD23	1:A:624:LEU:HA	1.96	0.40
1:A:610:TRP:CD1	1:A:660:PHE:HE1	2.39	0.40
1:A:802:PHE:O	1:A:806:MET:HG3	2.22	0.40
1:B:620:ARG:CZ	1:B:624:LEU:HD11	2.51	0.40
1:C:473:CYS:HB2	1:C:752:LEU:HD21	2.04	0.40
1:C:588:TRP:O	1:C:669:GLU:N	2.42	0.40
1:C:733:ILE:O	1:C:734:LEU:HD23	2.21	0.40
1:C:808:ARG:HB2	1:C:808:ARG:HE	1.62	0.40
1:D:571:PRO:HA	1:D:795:ARG:CZ	2.52	0.40

All (1) symmetry-related close contacts are listed below. The label for Atom-2 includes the symmetry operator and encoded unit-cell translations to be applied.

Atom-1	Atom-2	Interatomic distance (Å)	Clash overlap (Å)
1:A:539:TYR:OH	1:C:799:GLU:O[1_554]	2.07	0.13

5.3 Torsion angles [i](#)

5.3.1 Protein backbone [i](#)

In the following table, the Percentiles column shows the percent Ramachandran outliers of the chain as a percentile score with respect to all X-ray entries followed by that with respect to entries of similar resolution.

The Analysed column shows the number of residues for which the backbone conformation was analysed, and the total number of residues.

Mol	Chain	Analysed	Favoured	Allowed	Outliers	Percentiles	
1	A	502/554 (91%)	475 (95%)	23 (5%)	4 (1%)	19	51
1	B	501/554 (90%)	493 (98%)	7 (1%)	1 (0%)	47	77
1	C	502/554 (91%)	490 (98%)	12 (2%)	0	100	100
1	D	503/554 (91%)	493 (98%)	10 (2%)	0	100	100
All	All	2008/2216 (91%)	1951 (97%)	52 (3%)	5 (0%)	47	77

All (5) Ramachandran outliers are listed below:

Mol	Chain	Res	Type
1	A	515	PRO
1	B	747	ILE
1	A	580	PRO
1	A	671	VAL
1	A	577	PRO

5.3.2 Protein sidechains [i](#)

In the following table, the Percentiles column shows the percent sidechain outliers of the chain as a percentile score with respect to all X-ray entries followed by that with respect to entries of similar resolution.

The Analysed column shows the number of residues for which the sidechain conformation was analysed, and the total number of residues.

Mol	Chain	Analysed	Rotameric	Outliers	Percentiles	
1	A	438/476 (92%)	424 (97%)	14 (3%)	39	67

Continued on next page...

Continued from previous page...

Mol	Chain	Analysed	Rotameric	Outliers	Percentiles	
1	B	437/476 (92%)	437 (100%)	0	100	100
1	C	438/476 (92%)	435 (99%)	3 (1%)	84	90
1	D	439/476 (92%)	432 (98%)	7 (2%)	62	79
All	All	1752/1904 (92%)	1728 (99%)	24 (1%)	67	82

All (24) residues with a non-rotameric sidechain are listed below:

Mol	Chain	Res	Type
1	A	503	ASP
1	A	593	GLU
1	A	607	SER
1	A	609	LEU
1	A	617	GLU
1	A	679	ASP
1	A	788	ARG
1	A	792	ILE
1	A	829	ILE
1	A	830	ASN
1	A	840	TRP
1	A	842	LEU
1	A	846	PHE
1	A	850	THR
1	C	350	THR
1	C	455	ASP
1	C	457	VAL
1	D	356	GLU
1	D	464	ASP
1	D	492	CYS
1	D	533	LEU
1	D	572	LYS
1	D	573	ASP
1	D	575	VAL

Some sidechains can be flipped to improve hydrogen bonding and reduce clashes. All (3) such sidechains are listed below:

Mol	Chain	Res	Type
1	A	789	GLN
1	C	786	HIS
1	D	783	ASN

5.3.3 RNA [i](#)

There are no RNA molecules in this entry.

5.4 Non-standard residues in protein, DNA, RNA chains [i](#)

There are no non-standard protein/DNA/RNA residues in this entry.

5.5 Carbohydrates [i](#)

There are no carbohydrates in this entry.

5.6 Ligand geometry [i](#)

There are no ligands in this entry.

5.7 Other polymers [i](#)

There are no such residues in this entry.

5.8 Polymer linkage issues [i](#)

There are no chain breaks in this entry.

6 Fit of model and data [i](#)

6.1 Protein, DNA and RNA chains [i](#)

In the following table, the column labelled ‘#RSRZ> 2’ contains the number (and percentage) of RSRZ outliers, followed by percent RSRZ outliers for the chain as percentile scores relative to all X-ray entries and entries of similar resolution. The OWAB column contains the minimum, median, 95th percentile and maximum values of the occupancy-weighted average B-factor per residue. The column labelled ‘Q< 0.9’ lists the number of (and percentage) of residues with an average occupancy less than 0.9.

Mol	Chain	Analysed	<RSRZ>	#RSRZ>2	OWAB(Å ²)	Q<0.9
1	A	506/554 (91%)	0.42	41 (8%) 12 11	55, 117, 196, 232	0
1	B	505/554 (91%)	0.08	15 (2%) 50 49	46, 95, 147, 202	0
1	C	506/554 (91%)	0.21	21 (4%) 36 34	55, 122, 165, 197	0
1	D	507/554 (91%)	-0.01	11 (2%) 62 60	58, 104, 148, 212	0
All	All	2024/2216 (91%)	0.18	88 (4%) 35 34	46, 108, 172, 232	0

All (88) RSRZ outliers are listed below:

Mol	Chain	Res	Type	RSRZ
1	A	790	ALA	8.6
1	A	609	LEU	6.6
1	B	620	ARG	5.6
1	A	557	TYR	5.3
1	A	600	ASP	5.2
1	D	743	SER	4.8
1	A	620	ARG	4.6
1	A	788	ARG	4.4
1	A	789	GLN	4.3
1	A	519	PRO	4.3
1	A	611	MET	4.2
1	A	825	GLU	4.2
1	D	744	MET	4.1
1	D	504	GLY	4.1
1	B	743	SER	3.9
1	A	833	ALA	3.9
1	C	574	PHE	3.8
1	A	605	PRO	3.7
1	A	574	PHE	3.7
1	D	745	SER	3.6
1	B	575	VAL	3.5

Continued on next page...

Continued from previous page...

Mol	Chain	Res	Type	RSRZ
1	B	607	SER	3.4
1	A	662	SER	3.4
1	A	583	ILE	3.3
1	A	832	PRO	3.2
1	D	742	LEU	3.2
1	A	602	SER	3.1
1	C	544	GLY	3.1
1	C	526	SER	3.1
1	A	791	ASP	3.0
1	C	490	GLU	2.8
1	C	792	ILE	2.7
1	B	578	LYS	2.7
1	A	577	PRO	2.7
1	A	753	SER	2.7
1	B	574	PHE	2.7
1	C	541	LEU	2.6
1	B	606	ASP	2.6
1	D	673	ASP	2.6
1	A	538	SER	2.6
1	C	637	ILE	2.6
1	C	735	ASP	2.6
1	C	753	SER	2.6
1	C	522	ILE	2.5
1	A	630	ASP	2.5
1	B	618	LYS	2.5
1	B	745	SER	2.5
1	D	355	ALA	2.4
1	B	577	PRO	2.4
1	A	578	LYS	2.4
1	A	559	PRO	2.4
1	A	635	GLU	2.4
1	A	793	TYR	2.4
1	D	503	ASP	2.4
1	A	824	ALA	2.3
1	B	744	MET	2.3
1	C	837	ARG	2.3
1	D	380	CYS	2.3
1	C	674	SER	2.3
1	A	800	MET	2.3
1	B	750	TYR	2.3
1	A	563	PRO	2.3
1	A	731	SER	2.3

Continued on next page...

Continued from previous page...

Mol	Chain	Res	Type	RSRZ
1	A	799	GLU	2.3
1	C	638	SER	2.2
1	C	750	TYR	2.2
1	B	464	ASP	2.2
1	C	726	LYS	2.2
1	A	838	ARG	2.2
1	B	463	HIS	2.2
1	A	348	GLY	2.2
1	C	500	PRO	2.2
1	C	444	ASP	2.1
1	B	753	SER	2.1
1	D	812	ARG	2.1
1	A	512	ILE	2.1
1	D	750	TYR	2.1
1	C	846	PHE	2.1
1	A	636	ASN	2.1
1	A	575	VAL	2.1
1	A	597	THR	2.1
1	C	652	LEU	2.1
1	C	746	LYS	2.0
1	A	499	TRP	2.0
1	A	792	ILE	2.0
1	A	821	LEU	2.0
1	A	848	VAL	2.0
1	C	737	ARG	2.0

6.2 Non-standard residues in protein, DNA, RNA chains [i](#)

There are no non-standard protein/DNA/RNA residues in this entry.

6.3 Carbohydrates [i](#)

There are no carbohydrates in this entry.

6.4 Ligands [i](#)

There are no ligands in this entry.

6.5 Other polymers

There are no such residues in this entry.