



Full wwPDB X-ray Structure Validation Report ⓘ

Jan 7, 2024 – 01:38 pm GMT

PDB ID : 6G94
Title : Structure of E. coli hydrogenase-1 C19G variant in complex with cytochrome b
Authors : Volbeda, A.; Fontecilla-Camps, J.C.
Deposited on : 2018-04-10
Resolution : 2.50 Å (reported)

This is a Full wwPDB X-ray Structure Validation Report for a publicly released PDB entry.

We welcome your comments at validation@mail.wwpdb.org

A user guide is available at

<https://www.wwpdb.org/validation/2017/XrayValidationReportHelp>

with specific help available everywhere you see the ⓘ symbol.

The types of validation reports are described at

<http://www.wwpdb.org/validation/2017/FAQs#types>.

The following versions of software and data (see [references ⓘ](#)) were used in the production of this report:

MolProbity : 4.02b-467
Mogul : 1.8.4, CSD as541be (2020)
Xtriage (Phenix) : 1.13
EDS : 2.36
buster-report : 1.1.7 (2018)
Percentile statistics : 20191225.v01 (using entries in the PDB archive December 25th 2019)
Refmac : 5.8.0158
CCP4 : 7.0.044 (Gargrove)
Ideal geometry (proteins) : Engh & Huber (2001)
Ideal geometry (DNA, RNA) : Parkinson et al. (1996)
Validation Pipeline (wwPDB-VP) : 2.36

1 Overall quality at a glance i

The following experimental techniques were used to determine the structure:

X-RAY DIFFRACTION

The reported resolution of this entry is 2.50 Å.

Percentile scores (ranging between 0-100) for global validation metrics of the entry are shown in the following graphic. The table shows the number of entries on which the scores are based.

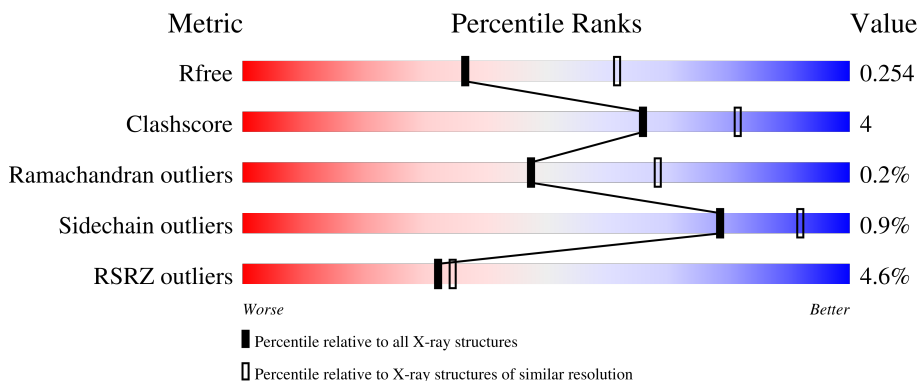

Metric	Whole archive (#Entries)	Similar resolution (#Entries, resolution range(Å))
R_{free}	130704	4661 (2.50-2.50)
Clashscore	141614	5346 (2.50-2.50)
Ramachandran outliers	138981	5231 (2.50-2.50)
Sidechain outliers	138945	5233 (2.50-2.50)
RSRZ outliers	127900	4559 (2.50-2.50)

The table below summarises the geometric issues observed across the polymeric chains and their fit to the electron density. The red, orange, yellow and green segments of the lower bar indicate the fraction of residues that contain outliers for ≥ 3 , 2, 1 and 0 types of geometric quality criteria respectively. A grey segment represents the fraction of residues that are not modelled. The numeric value for each fraction is indicated below the corresponding segment, with a dot representing fractions $\leq 5\%$. The upper red bar (where present) indicates the fraction of residues that have poor fit to the electron density. The numeric value is given above the bar.

Mol	Chain	Length	Quality of chain
1	Q	335	10% 81% 7% 12%
1	R	335	10% 76% 10% 13%
1	S	335	1% 80% 8% 12%
1	T	335	4% 77% 10% 12%
2	J	582	1% 90% 10%

Continued on next page...

Continued from previous page...

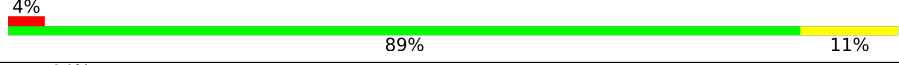
Mol	Chain	Length	Quality of chain
2	K	582	 3% 91% 9%
2	L	582	 % 91% 9%
2	M	582	 4% 89% 11%
3	A	235	 14% 62% 11% 27%
3	B	235	 15% 59% 9% 32%

2 Entry composition i

There are 12 unique types of molecules in this entry. The entry contains 30463 atoms, of which 0 are hydrogens and 0 are deuteriums.

In the tables below, the ZeroOcc column contains the number of atoms modelled with zero occupancy, the AltConf column contains the number of residues with at least one atom in alternate conformation and the Trace column contains the number of residues modelled with at most 2 atoms.

- Molecule 1 is a protein called Hydrogenase-1 small chain.

Mol	Chain	Residues	Atoms					ZeroOcc	AltConf	Trace
			Total	C	N	O	S			
1	S	296	2242	1420	385	417	20	0	0	0
1	T	296	2220	1408	379	413	20	0	0	0
1	Q	295	2234	1416	383	415	20	0	0	0
1	R	291	2203	1394	378	411	20	0	0	0

There are 36 discrepancies between the modelled and reference sequences:

Chain	Residue	Modelled	Actual	Comment	Reference
S	19	GLY	CYS	conflict	UNP P69739
S	328	ARG	-	expression tag	UNP P69739
S	329	SER	-	expression tag	UNP P69739
S	330	HIS	-	expression tag	UNP P69739
S	331	HIS	-	expression tag	UNP P69739
S	332	HIS	-	expression tag	UNP P69739
S	333	HIS	-	expression tag	UNP P69739
S	334	HIS	-	expression tag	UNP P69739
S	335	HIS	-	expression tag	UNP P69739
T	19	GLY	CYS	conflict	UNP P69739
T	328	ARG	-	expression tag	UNP P69739
T	329	SER	-	expression tag	UNP P69739
T	330	HIS	-	expression tag	UNP P69739
T	331	HIS	-	expression tag	UNP P69739
T	332	HIS	-	expression tag	UNP P69739
T	333	HIS	-	expression tag	UNP P69739
T	334	HIS	-	expression tag	UNP P69739
T	335	HIS	-	expression tag	UNP P69739
Q	19	GLY	CYS	conflict	UNP P69739
Q	328	ARG	-	expression tag	UNP P69739
Q	329	SER	-	expression tag	UNP P69739

Continued on next page...

Continued from previous page...

Chain	Residue	Modelled	Actual	Comment	Reference
Q	330	HIS	-	expression tag	UNP P69739
Q	331	HIS	-	expression tag	UNP P69739
Q	332	HIS	-	expression tag	UNP P69739
Q	333	HIS	-	expression tag	UNP P69739
Q	334	HIS	-	expression tag	UNP P69739
Q	335	HIS	-	expression tag	UNP P69739
R	19	GLY	CYS	conflict	UNP P69739
R	328	ARG	-	expression tag	UNP P69739
R	329	SER	-	expression tag	UNP P69739
R	330	HIS	-	expression tag	UNP P69739
R	331	HIS	-	expression tag	UNP P69739
R	332	HIS	-	expression tag	UNP P69739
R	333	HIS	-	expression tag	UNP P69739
R	334	HIS	-	expression tag	UNP P69739
R	335	HIS	-	expression tag	UNP P69739

- Molecule 2 is a protein called Hydrogenase-1 large chain.

Mol	Chain	Residues	Atoms					ZeroOcc	AltConf	Trace
			Total	C	N	O	S			
2	L	581	Total 4526	C 2874	N 787	O 838	S 27	0	1	0
2	M	581	Total 4512	C 2869	N 787	O 829	S 27	0	0	0
2	J	581	Total 4528	C 2876	N 792	O 833	S 27	0	0	0
2	K	581	Total 4526	C 2873	N 791	O 835	S 27	0	0	0

- Molecule 3 is a protein called Probable Ni/Fe-hydrogenase 1 B-type cytochrome subunit.

Mol	Chain	Residues	Atoms					ZeroOcc	AltConf	Trace
			Total	C	N	O	S			
3	A	172	Total 1310	C 888	N 204	O 207	S 11	0	0	0
3	B	160	Total 1242	C 842	N 196	O 194	S 10	0	0	0

- Molecule 4 is IRON/SULFUR CLUSTER (three-letter code: SF4) (formula: Fe₄S₄).



Mol	Chain	Residues	Atoms		ZeroOcc	AltConf
4	S	1	Total	Fe S	0	0
			8	4 4		
4	T	1	Total	Fe S	0	0
			8	4 4		
4	Q	1	Total	Fe S	0	0
			8	4 4		
4	R	1	Total	Fe S	0	0
			8	4 4		

- Molecule 5 is FE3-S4 CLUSTER (three-letter code: F3S) (formula: Fe₃S₄).

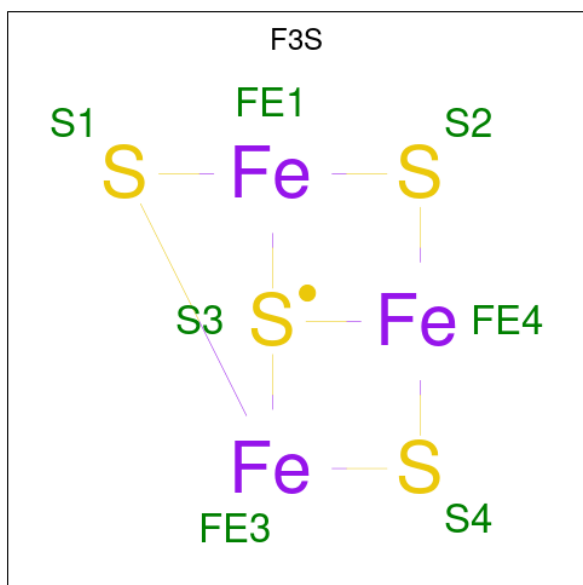

Mol	Chain	Residues	Atoms	ZeroOcc	AltConf
5	S	1	Total Fe S 7 3 4	0	0
5	T	1	Total Fe S 7 3 4	0	0
5	Q	1	Total Fe S 7 3 4	0	0
5	R	1	Total Fe S 7 3 4	0	0

- Molecule 6 is Fe4S4 (three-letter code: ER2) (formula: Fe₄S₄).

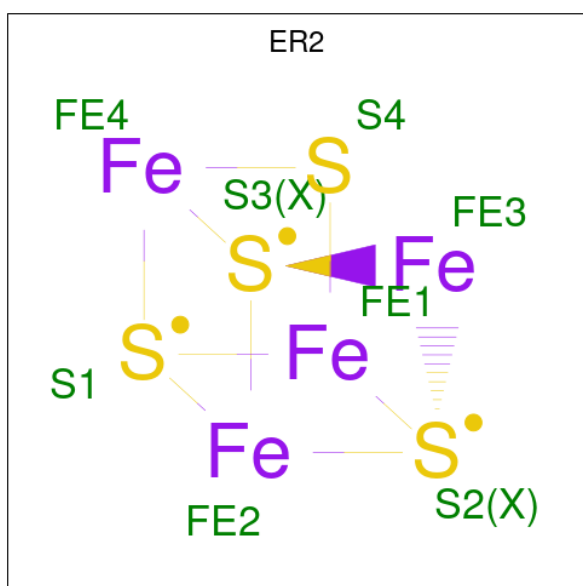

Mol	Chain	Residues	Atoms	ZeroOcc	AltConf
6	S	1	Total Fe S 8 4 4	0	0
6	T	1	Total Fe S 8 4 4	0	0
6	Q	1	Total Fe S 8 4 4	0	0
6	R	1	Total Fe S 8 4 4	0	0

- Molecule 7 is CARBONMONOXIDE-(DICYANO) IRON (three-letter code: FCO) (formula: C₃FeN₂O).

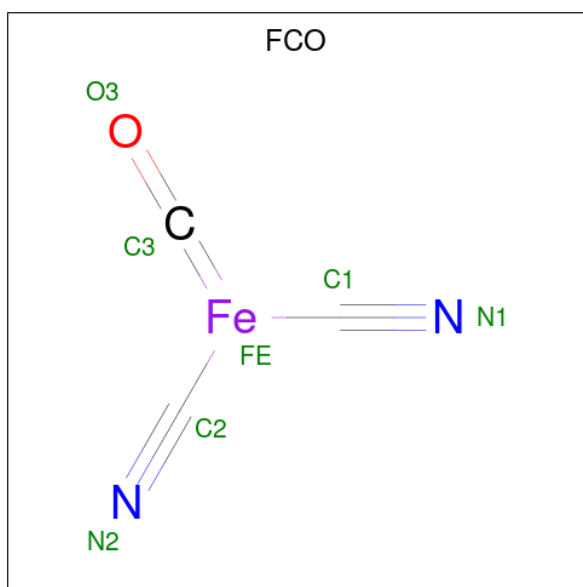

Mol	Chain	Residues	Atoms					ZeroOcc	AltConf
7	L	1	Total	C	Fe	N	O	0	0
			7	3	1	2	1		
7	M	1	Total	C	Fe	N	O	0	0
			7	3	1	2	1		
7	J	1	Total	C	Fe	N	O	0	0
			7	3	1	2	1		
7	K	1	Total	C	Fe	N	O	0	0
			7	3	1	2	1		

- Molecule 8 is NICKEL (II) ION (three-letter code: NI) (formula: Ni).

Mol	Chain	Residues	Atoms		ZeroOcc	AltConf
8	L	1	Total	Ni	0	0
			1	1		
8	M	1	Total	Ni	0	0
			1	1		
8	J	1	Total	Ni	0	0
			1	1		
8	K	1	Total	Ni	0	0
			1	1		

- Molecule 9 is MAGNESIUM ION (three-letter code: MG) (formula: Mg).

Mol	Chain	Residues	Atoms		ZeroOcc	AltConf
9	L	1	Total	Mg	0	0
			1	1		

Continued on next page...

Continued from previous page...

Mol	Chain	Residues	Atoms	ZeroOcc	AltConf
9	M	1	Total Mg 1 1	0	0
9	J	1	Total Mg 1 1	0	0
9	K	1	Total Mg 1 1	0	0

- Molecule 10 is CHLORIDE ION (three-letter code: CL) (formula: Cl).

Mol	Chain	Residues	Atoms	ZeroOcc	AltConf
10	L	1	Total Cl 1 1	0	0
10	M	1	Total Cl 1 1	0	0
10	J	1	Total Cl 1 1	0	0
10	K	1	Total Cl 1 1	0	0

- Molecule 11 is PROTOPORPHYRIN IX CONTAINING FE (three-letter code: HEM) (formula: C₃₄H₃₂FeN₄O₄).

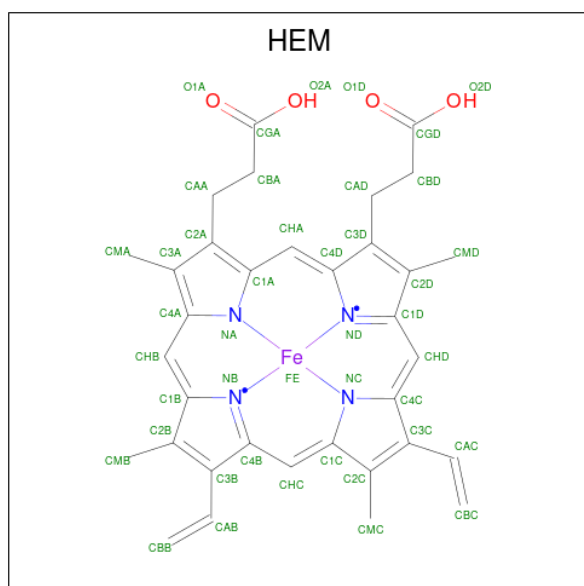

Mol	Chain	Residues	Atoms	ZeroOcc	AltConf
11	A	1	Total C Fe N O 43 34 1 4 4	0	0
11	B	1	Total C Fe N O 43 34 1 4 4	0	0

- Molecule 12 is water.

Mol	Chain	Residues	Atoms	ZeroOcc	AltConf
12	S	62	Total O 62 62	0	0
12	L	111	Total O 111 111	0	0
12	T	59	Total O 59 59	0	0
12	M	113	Total O 113 113	0	0
12	Q	62	Total O 62 62	0	0
12	J	112	Total O 112 112	0	0
12	R	63	Total O 63 63	0	0
12	K	108	Total O 108 108	0	0
12	A	6	Total O 6 6	0	0
12	B	6	Total O 6 6	0	0

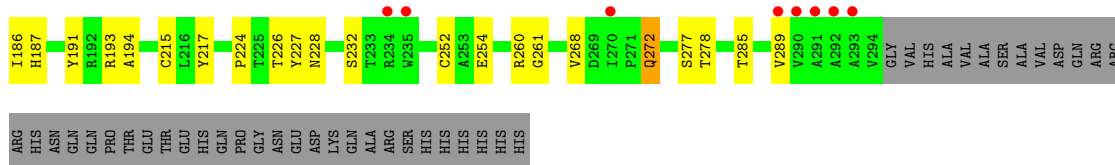

- Molecule 2: Hydrogenase-1 large chain

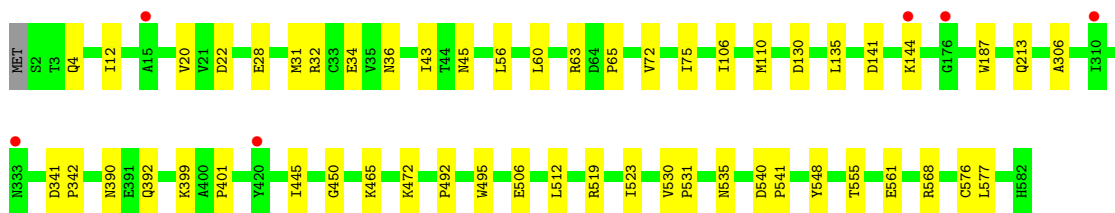
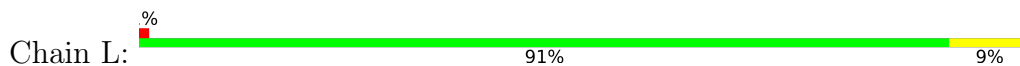

- Molecule 2: Hydrogenase-1 large chain

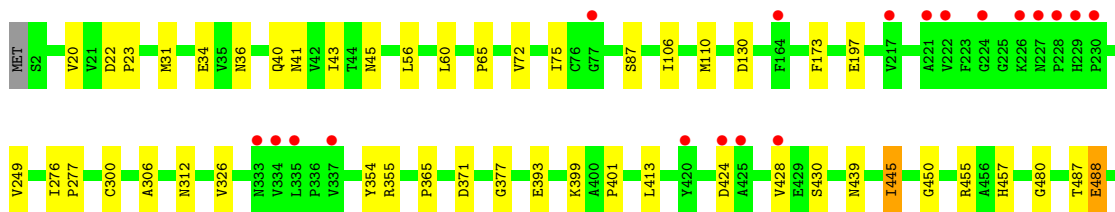
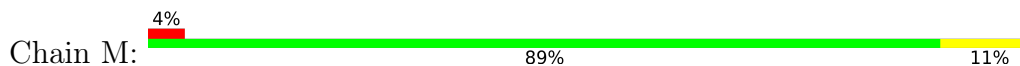

- Molecule 2: Hydrogenase-1 large chain

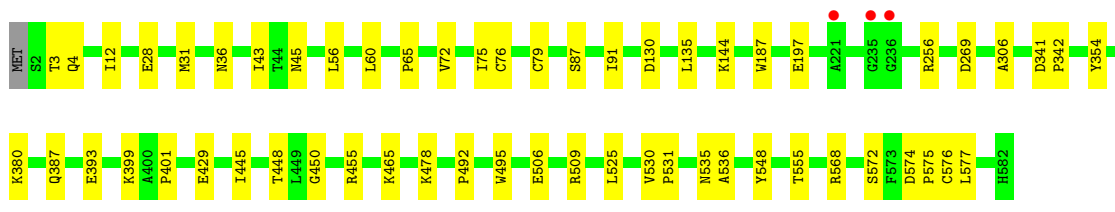
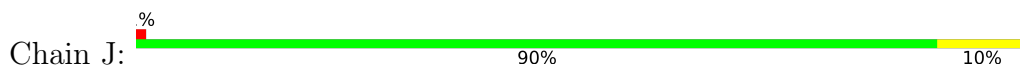

- Molecule 2: Hydrogenase-1 large chain

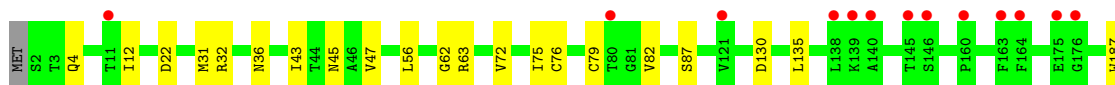
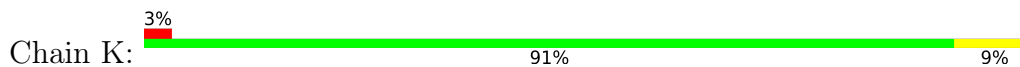

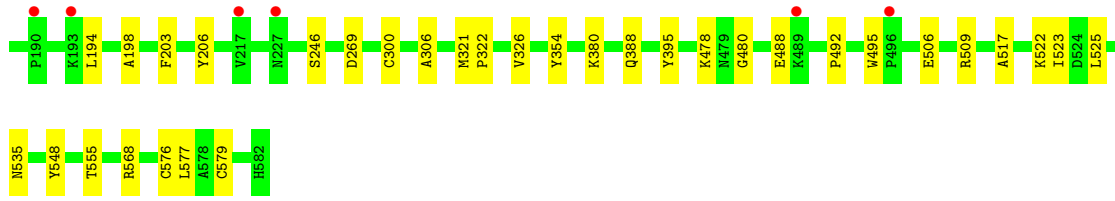

- Molecule 3: Probable Ni/Fe-hydrogenase 1 B-type cytochrome subunit

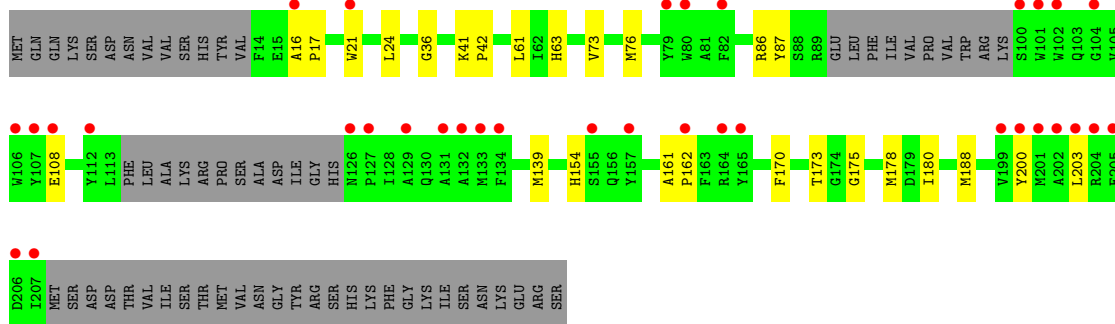

- Molecule 3: Probable Ni/Fe-hydrogenase 1 B-type cytochrome subunit

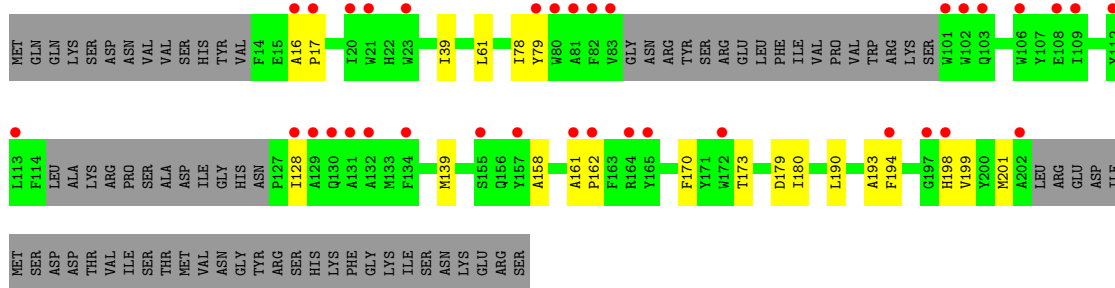

4 Data and refinement statistics

Property	Value	Source
Space group	P 21 21 21	Depositor
Cell constants a, b, c, α , β , γ	124.41Å 165.03Å 206.22Å 90.00° 90.00° 90.00°	Depositor
Resolution (Å)	25.00 – 2.50 49.67 – 2.50	Depositor EDS
% Data completeness (in resolution range)	97.6 (25.00-2.50) 97.7 (49.67-2.50)	Depositor EDS
R_{merge}	0.30	Depositor
R_{sym}	(Not available)	Depositor
$\langle I/\sigma(I) \rangle$ ¹	1.50 (at 2.51Å)	Xtrriage
Refinement program	REFMAC 5.8.0189	Depositor
R, R_{free}	0.222 , 0.253 0.223 , 0.254	Depositor DCC
R_{free} test set	7076 reflections (4.93%)	wwPDB-VP
Wilson B-factor (Å ²)	42.3	Xtrriage
Anisotropy	0.490	Xtrriage
Bulk solvent k_{sol} (e/Å ³), B_{sol} (Å ²)	0.31 , 20.3	EDS
L-test for twinning ²	$\langle L \rangle = 0.46$, $\langle L^2 \rangle = 0.28$	Xtrriage
Estimated twinning fraction	No twinning to report.	Xtrriage
F_o, F_c correlation	0.93	EDS
Total number of atoms	30463	wwPDB-VP
Average B, all atoms (Å ²)	52.0	wwPDB-VP

Xtrriage's analysis on translational NCS is as follows: *The largest off-origin peak in the Patterson function is 1.81% of the height of the origin peak. No significant pseudotranslation is detected.*

¹Intensities estimated from amplitudes.

²Theoretical values of $\langle |L| \rangle$, $\langle L^2 \rangle$ for acentric reflections are 0.5, 0.333 respectively for untwinned datasets, and 0.375, 0.2 for perfectly twinned datasets.

5 Model quality

5.1 Standard geometry

Bond lengths and bond angles in the following residue types are not validated in this section: FCO, MG, HEM, NI, F3S, CL, SF4, ER2

The Z score for a bond length (or angle) is the number of standard deviations the observed value is removed from the expected value. A bond length (or angle) with $|Z| > 5$ is considered an outlier worth inspection. RMSZ is the root-mean-square of all Z scores of the bond lengths (or angles).

Mol	Chain	Bond lengths		Bond angles	
		RMSZ	# Z >5	RMSZ	# Z >5
1	Q	0.50	0/2292	0.57	0/3120
1	R	0.50	0/2260	0.59	0/3077
1	S	0.50	0/2300	0.61	0/3131
1	T	0.49	0/2278	0.60	0/3104
2	J	0.49	0/4647	0.58	1/6328 (0.0%)
2	K	0.48	0/4645	0.56	0/6327
2	L	0.51	0/4648	0.57	0/6332
2	M	0.48	0/4631	0.59	0/6308
3	A	0.59	0/1356	0.65	0/1848
3	B	0.55	0/1288	0.64	0/1753
All	All	0.50	0/30345	0.59	1/41328 (0.0%)

There are no bond length outliers.

All (1) bond angle outliers are listed below:

Mol	Chain	Res	Type	Atoms	Z	Observed(°)	Ideal(°)
2	J	256	ARG	NE-CZ-NH2	-5.95	117.33	120.30

There are no chirality outliers.

There are no planarity outliers.

5.2 Too-close contacts

In the following table, the Non-H and H(model) columns list the number of non-hydrogen atoms and hydrogen atoms in the chain respectively. The H(added) column lists the number of hydrogen atoms added and optimized by MolProbity. The Clashes column lists the number of clashes within the asymmetric unit, whereas Symm-Clashes lists symmetry-related clashes.

Mol	Chain	Non-H	H(model)	H(added)	Clashes	Symm-Clashes
1	Q	2234	0	2164	20	0
1	R	2203	0	2121	22	0
1	S	2242	0	2170	18	0
1	T	2220	0	2129	28	0
2	J	4528	0	4390	34	0
2	K	4526	0	4379	31	0
2	L	4526	0	4376	33	0
2	M	4512	0	4371	38	0
3	A	1310	0	1188	21	0
3	B	1242	0	1141	14	0
4	Q	8	0	0	0	0
4	R	8	0	0	0	0
4	S	8	0	0	0	0
4	T	8	0	0	0	0
5	Q	7	0	0	0	0
5	R	7	0	0	0	0
5	S	7	0	0	0	0
5	T	7	0	0	0	0
6	Q	8	0	0	0	0
6	R	8	0	0	0	0
6	S	8	0	0	0	0
6	T	8	0	0	0	0
7	J	7	0	0	0	0
7	K	7	0	0	0	0
7	L	7	0	0	0	0
7	M	7	0	0	0	0
8	J	1	0	0	0	0
8	K	1	0	0	0	0
8	L	1	0	0	0	0
8	M	1	0	0	0	0
9	J	1	0	0	0	0
9	K	1	0	0	0	0
9	L	1	0	0	0	0
9	M	1	0	0	0	0
10	J	1	0	0	0	0
10	K	1	0	0	0	0
10	L	1	0	0	0	0
10	M	1	0	0	0	0
11	A	43	0	30	5	0
11	B	43	0	30	0	0
12	A	6	0	0	1	0
12	B	6	0	0	0	0
12	J	112	0	0	6	0

Continued on next page...

Continued from previous page...

Mol	Chain	Non-H	H(model)	H(added)	Clashes	Symm-Clashes
12	K	108	0	0	3	0
12	L	111	0	0	1	0
12	M	113	0	0	7	0
12	Q	62	0	0	1	0
12	R	63	0	0	0	0
12	S	62	0	0	1	0
12	T	59	0	0	0	0
All	All	30463	0	28489	231	0

The all-atom clashscore is defined as the number of clashes found per 1000 atoms (including hydrogen atoms). The all-atom clashscore for this structure is 4.

All (231) close contacts within the same asymmetric unit are listed below, sorted by their clash magnitude.

Atom-1	Atom-2	Interatomic distance (Å)	Clash overlap (Å)
3:B:78:ILE:HG13	3:B:79:TYR:H	1.21	1.02
3:B:78:ILE:HG13	3:B:79:TYR:N	1.77	0.95
2:J:3:THR:HB	12:J:717:HOH:O	1.70	0.91
3:A:16:ALA:HB1	3:A:17:PRO:HD2	1.65	0.79
1:T:260:ARG:HH21	3:A:175:GLY:HA2	1.54	0.72
3:B:16:ALA:HB1	3:B:17:PRO:CD	2.25	0.67
1:S:186:ILE:HD11	1:S:228:ASN:HB3	1.74	0.67
2:L:519:ARG:HG2	2:L:519:ARG:HH11	1.62	0.65
11:A:301:HEM:HMB1	11:A:301:HEM:HBB2	1.79	0.65
1:R:186:ILE:HD11	1:R:228:ASN:HB3	1.80	0.64
2:J:43:ILE:HD12	2:J:555:THR:HB	1.79	0.64
1:T:186:ILE:HD11	1:T:228:ASN:HB3	1.81	0.62
1:T:260:ARG:HH21	3:A:175:GLY:CA	2.13	0.61
3:B:16:ALA:HB1	3:B:17:PRO:HD2	1.83	0.60
2:M:36:ASN:HB2	2:M:45:ASN:HB3	1.83	0.59
1:Q:186:ILE:HD11	1:Q:228:ASN:HB3	1.84	0.59
3:A:41:LYS:HG3	12:A:405:HOH:O	2.03	0.59
3:B:78:ILE:CG1	3:B:79:TYR:N	2.61	0.58
2:K:56:LEU:HD22	2:K:75:ILE:HG13	1.85	0.57
2:L:530:VAL:HG12	2:L:531:PRO:HD2	1.86	0.57
1:T:133:PRO:HG2	1:T:136:LYS:HG2	1.87	0.57
1:S:187:HIS:CD2	1:S:193:ARG:NH1	2.73	0.56
2:L:36:ASN:HB2	2:L:45:ASN:HB3	1.88	0.55
2:M:517:ALA:HB3	2:M:525:LEU:HB3	1.89	0.55
2:K:354:TYR:HB3	12:K:774:HOH:O	2.07	0.55
2:L:141:ASP:HB3	2:L:144:LYS:HD2	1.89	0.54

Continued on next page...

Continued from previous page...

Atom-1	Atom-2	Interatomic distance (Å)	Clash overlap (Å)
11:A:301:HEM:HBB2	11:A:301:HEM:CMB	2.37	0.54
1:S:275:THR:HA	3:A:61:LEU:HD12	1.89	0.54
2:J:4:GLN:HA	2:J:12:ILE:O	2.07	0.54
2:L:135:LEU:HD13	2:L:187:TRP:CD1	2.43	0.54
2:J:56:LEU:HD22	2:J:75:ILE:HG13	1.89	0.54
3:B:139:MET:HA	3:B:139:MET:CE	2.37	0.54
2:M:424:ASP:O	2:M:428:VAL:HG23	2.08	0.53
2:K:36:ASN:HB2	2:K:45:ASN:HB3	1.90	0.53
2:K:130:ASP:HB3	2:K:568:ARG:HG2	1.89	0.53
1:S:193:ARG:HG3	1:T:194:ALA:HB2	1.90	0.53
1:Q:194:ALA:HB2	1:R:193:ARG:HG3	1.91	0.53
1:Q:165:THR:CG2	2:K:478:LYS:HE2	2.39	0.52
2:L:530:VAL:CG1	2:L:531:PRO:HD2	2.39	0.52
1:R:261:GLY:HA3	1:R:268:VAL:HB	1.92	0.52
2:L:576:CYS:CB	12:L:808:HOH:O	2.57	0.52
2:M:56:LEU:HD22	2:M:75:ILE:HG13	1.92	0.52
2:K:535:ASN:HB3	2:K:548:TYR:CE1	2.44	0.52
2:L:130:ASP:HB3	2:L:568:ARG:HG2	1.92	0.52
1:T:280:ASP:O	1:T:284:LEU:HB2	2.10	0.52
2:K:62:GLY:O	2:K:522:LYS:HD2	2.09	0.52
1:T:262:SER:HB3	1:T:265:SER:OG	2.10	0.51
1:R:35:VAL:HA	1:R:39:LEU:HB2	1.91	0.51
1:S:171:ASP:OD1	2:K:480:GLY:HA3	2.11	0.51
1:T:298:ALA:HB2	3:A:200:TYR:CE1	2.46	0.51
2:M:43:ILE:HD12	2:M:555:THR:HB	1.92	0.50
2:M:31:MET:HB2	2:M:577:LEU:HG	1.93	0.50
2:J:36:ASN:HB2	2:J:45:ASN:HB3	1.92	0.50
1:R:268:VAL:C	1:R:278:THR:HG22	2.32	0.50
2:L:60:LEU:HD11	2:L:72:VAL:HG13	1.94	0.50
2:L:56:LEU:HD22	2:L:75:ILE:HG13	1.94	0.50
1:T:260:ARG:NH2	3:A:175:GLY:HA2	2.24	0.50
2:M:430:SER:OG	2:M:457:HIS:CE1	2.65	0.50
2:J:56:LEU:HD22	2:J:75:ILE:CG1	2.41	0.50
2:L:31:MET:HB2	2:L:577:LEU:HG	1.93	0.50
1:S:232:SER:OG	2:M:249:VAL:HB	2.12	0.49
2:L:399:LYS:O	2:L:401:PRO:HD3	2.11	0.49
1:Q:183:GLY:HA3	2:K:246:SER:HB2	1.94	0.49
2:L:22:ASP:HB2	2:L:32:ARG:HG3	1.95	0.49
2:M:576:CYS:CB	12:M:812:HOH:O	2.60	0.48
1:Q:193:ARG:HG3	1:R:194:ALA:HB2	1.95	0.48
2:M:535:ASN:HB3	2:M:548:TYR:CE1	2.48	0.48

Continued on next page...

Continued from previous page...

Atom-1	Atom-2	Interatomic distance (Å)	Clash overlap (Å)
2:L:43:ILE:HD12	2:L:555:THR:HB	1.95	0.48
1:T:272:GLN:NE2	3:A:173:THR:HG23	2.28	0.48
2:M:365:PRO:HA	12:M:751:HOH:O	2.12	0.48
1:S:294:VAL:HG12	1:S:296:VAL:HG23	1.96	0.48
1:S:22:GLU:O	1:S:26:ARG:HG2	2.14	0.48
2:K:76:CYS:HB3	2:K:79:CYS:SG	2.53	0.48
2:L:306:ALA:HB2	2:L:506:GLU:H	1.79	0.48
1:R:226:THR:HG23	1:R:254:GLU:HG2	1.94	0.48
1:R:285:THR:O	1:R:289:VAL:HG23	2.14	0.47
2:J:306:ALA:HB2	2:J:506:GLU:H	1.80	0.47
3:B:170:PHE:CD2	3:B:180:ILE:HG12	2.49	0.47
2:L:519:ARG:HG2	2:L:519:ARG:NH1	2.25	0.47
2:J:393:GLU:HB3	12:J:784:HOH:O	2.14	0.47
2:L:65:PRO:HA	2:L:523:ILE:HD11	1.97	0.47
2:L:535:ASN:HB3	2:L:548:TYR:CE1	2.50	0.47
2:J:354:TYR:HB3	12:J:729:HOH:O	2.15	0.47
1:Q:218:LYS:HE2	1:Q:266:ARG:HH22	1.80	0.47
2:K:72:VAL:HG21	2:K:87:SER:HB2	1.96	0.47
2:M:72:VAL:HG21	2:M:87:SER:HB2	1.97	0.46
1:R:215:CYS:SG	1:R:217:TYR:HB2	2.55	0.46
2:K:63:ARG:O	2:K:523:ILE:HG13	2.16	0.46
2:K:509:ARG:HD2	12:K:805:HOH:O	2.13	0.46
2:M:355:ARG:NH1	2:M:371:ASP:OD2	2.44	0.46
3:B:194:PHE:O	3:B:198:HIS:N	2.42	0.46
1:T:14:GLY:O	1:T:16:GLU:HG2	2.16	0.46
2:J:135:LEU:HD13	2:J:187:TRP:CD1	2.50	0.46
2:K:43:ILE:HD12	2:K:555:THR:HB	1.97	0.46
3:A:24:LEU:HD23	3:A:73:VAL:HG21	1.97	0.46
1:T:7:ILE:HD12	1:T:8:PRO:HD2	1.98	0.46
2:M:480:GLY:HA3	1:Q:171:ASP:OD1	2.16	0.46
2:J:72:VAL:HG21	2:J:87:SER:HB2	1.97	0.46
2:L:492:PRO:HA	2:L:495:TRP:CD2	2.50	0.46
1:Q:7:ILE:HD12	1:Q:8:PRO:HD2	1.97	0.46
2:J:130:ASP:HB3	2:J:568:ARG:HG2	1.98	0.46
2:M:377:GLY:HA3	2:M:393:GLU:OE2	2.16	0.45
3:A:36:GLY:HA3	11:A:301:HEM:C4A	2.50	0.45
2:M:399:LYS:O	2:M:401:PRO:HD3	2.16	0.45
1:S:7:ILE:HD12	1:S:8:PRO:HD2	1.99	0.45
3:B:190:LEU:O	3:B:193:ALA:HB3	2.17	0.45
2:M:455:ARG:HD2	12:M:768:HOH:O	2.16	0.45
2:J:380:LYS:HB2	2:J:387:GLN:HB2	1.99	0.45

Continued on next page...

Continued from previous page...

Atom-1	Atom-2	Interatomic distance (Å)	Clash overlap (Å)
2:M:354:TYR:HB3	12:M:753:HOH:O	2.16	0.45
2:J:399:LYS:O	2:J:401:PRO:HD3	2.16	0.45
1:T:272:GLN:HE22	3:A:173:THR:HG23	1.81	0.45
1:Q:125:ARG:HA	1:Q:126:PRO:HA	1.78	0.45
2:J:509:ARG:HD2	12:J:806:HOH:O	2.16	0.45
2:M:40:GLN:O	2:M:41:ASN:HB2	2.17	0.45
2:K:47:VAL:HG13	2:K:395:TYR:CE2	2.52	0.45
1:T:260:ARG:NH1	1:T:271:PRO:HG2	2.32	0.45
2:M:492:PRO:HA	2:M:495:TRP:CD2	2.52	0.44
3:A:16:ALA:HB1	3:A:17:PRO:CD	2.37	0.44
2:M:60:LEU:HD11	2:M:72:VAL:HG13	2.00	0.44
2:M:511:ALA:O	2:M:531:PRO:HD3	2.18	0.44
1:T:79:PRO:HD2	1:T:132:THR:O	2.16	0.44
2:J:445:ILE:O	2:J:450:GLY:HA3	2.18	0.44
2:J:492:PRO:HA	2:J:495:TRP:CD2	2.52	0.44
1:S:194:ALA:HB2	1:T:193:ARG:HG3	1.99	0.44
2:M:197:GLU:CD	2:M:197:GLU:H	2.20	0.44
2:J:530:VAL:CG1	2:J:531:PRO:HD2	2.47	0.44
2:K:492:PRO:HA	2:K:495:TRP:CD2	2.52	0.44
2:K:300:CYS:HA	2:K:326:VAL:O	2.17	0.44
2:K:517:ALA:HB3	2:K:525:LEU:HB3	1.99	0.44
2:J:576:CYS:CB	12:J:806:HOH:O	2.66	0.44
2:K:22:ASP:HB2	2:K:32:ARG:HG3	2.00	0.44
1:T:273:MET:O	1:T:277:SER:HB2	2.18	0.44
1:Q:274:GLY:O	3:B:61:LEU:HD12	2.17	0.44
2:K:31:MET:HB2	2:K:577:LEU:HG	2.00	0.44
2:M:488:GLU:OE1	1:Q:174:ARG:NH1	2.51	0.43
2:K:4:GLN:HA	2:K:12:ILE:O	2.17	0.43
2:K:380:LYS:HB2	2:K:388:GLN:HB2	1.99	0.43
3:B:161:ALA:N	3:B:162:PRO:HD2	2.34	0.43
2:M:20:VAL:HG22	2:M:34:GLU:HG2	2.00	0.43
2:L:445:ILE:O	2:L:450:GLY:HA3	2.19	0.43
1:Q:189:LYS:O	1:Q:231:SER:HB2	2.19	0.43
1:R:217:TYR:OH	3:B:39:ILE:O	2.25	0.43
2:M:106:ILE:O	2:M:110:MET:HG2	2.19	0.43
1:R:272:GLN:NE2	3:B:173:THR:HG23	2.33	0.43
2:K:79:CYS:O	2:K:82:VAL:HG12	2.19	0.43
2:K:203:PHE:O	2:K:206:TYR:HB3	2.19	0.43
1:S:118:TRP:CD2	1:S:255:ASN:HB2	2.54	0.43
1:T:225:THR:HG21	3:A:178:MET:HA	2.00	0.43
2:M:312:ASN:HA	12:M:743:HOH:O	2.19	0.43

Continued on next page...

Continued from previous page...

Atom-1	Atom-2	Interatomic distance (Å)	Clash overlap (Å)
1:Q:13:HIS:HD2	12:Q:510:HOH:O	2.02	0.42
2:J:455:ARG:HD2	12:J:773:HOH:O	2.18	0.42
1:S:197:ASP:OD2	1:T:197:ASP:OD2	2.37	0.42
3:A:21:TRP:CE3	3:A:76:MET:HE2	2.54	0.42
2:K:306:ALA:HB2	2:K:506:GLU:H	1.84	0.42
1:T:193:ARG:HD2	1:T:193:ARG:HA	1.82	0.42
2:J:60:LEU:HD11	2:J:72:VAL:CG1	2.49	0.42
1:S:297:HIS:O	1:S:298:ALA:HB3	2.19	0.42
2:L:512:LEU:HD13	2:L:530:VAL:HG13	2.01	0.42
2:M:445:ILE:O	2:M:450:GLY:HA3	2.20	0.42
1:R:77:GLY:HA2	1:R:115:CYS:HB3	2.02	0.42
1:R:260:ARG:NH2	3:B:179:ASP:OD2	2.48	0.42
1:Q:165:THR:HG23	2:K:478:LYS:HE2	2.01	0.42
1:Q:174:ARG:HG2	1:Q:174:ARG:HH21	1.85	0.42
1:T:37:LEU:HD22	2:M:173:PHE:CD1	2.55	0.42
2:M:276:ILE:HB	2:M:277:PRO:HD3	2.01	0.42
2:M:509:ARG:HD2	12:M:812:HOH:O	2.19	0.42
1:Q:29:HIS:HA	1:Q:30:PRO:HA	1.91	0.42
1:Q:79:PRO:HD2	1:Q:132:THR:O	2.20	0.42
3:A:170:PHE:CD2	3:A:180:ILE:HG12	2.55	0.42
1:S:297:HIS:HD2	12:S:523:HOH:O	2.01	0.42
1:R:78:ASN:HB2	1:R:132:THR:O	2.20	0.42
1:R:185:ARG:HD3	1:R:227:TYR:CZ	2.55	0.42
3:A:24:LEU:HD12	3:A:24:LEU:HA	1.83	0.42
2:L:390:ASN:OD1	2:L:392:GLN:HB2	2.19	0.41
3:A:161:ALA:N	3:A:162:PRO:HD2	2.35	0.41
1:T:25:ILE:HA	1:T:32:ALA:HB2	2.02	0.41
2:M:300:CYS:HA	2:M:326:VAL:O	2.20	0.41
2:J:28:GLU:HB3	2:J:576:CYS:HA	2.02	0.41
1:R:22:GLU:O	1:R:26:ARG:HG2	2.20	0.41
2:L:56:LEU:HD22	2:L:75:ILE:CG1	2.50	0.41
2:J:65:PRO:HB3	2:J:91:ILE:HD12	2.01	0.41
2:J:448:THR:HG23	2:J:572:SER:HB3	2.03	0.41
1:T:218:LYS:HE3	3:A:42:PRO:HB2	2.02	0.41
2:M:22:ASP:HA	2:M:23:PRO:HA	1.94	0.41
2:M:130:ASP:HB3	2:M:568:ARG:HG2	2.02	0.41
2:M:306:ALA:HB2	2:M:506:GLU:H	1.85	0.41
3:A:63:HIS:CE1	11:A:301:HEM:NA	2.88	0.41
2:L:341:ASP:HA	2:L:342:PRO:HD3	1.94	0.41
1:T:125:ARG:HA	1:T:126:PRO:HA	1.66	0.41
2:K:194:LEU:HB3	2:K:198:ALA:HB3	2.01	0.41

Continued on next page...

Continued from previous page...

Atom-1	Atom-2	Interatomic distance (Å)	Clash overlap (Å)
2:J:535:ASN:HB3	2:J:548:TYR:CE1	2.55	0.41
1:R:133:PRO:HG2	1:R:136:LYS:HG2	2.02	0.41
1:R:79:PRO:HD2	1:R:132:THR:O	2.21	0.41
2:K:576:CYS:CB	12:K:805:HOH:O	2.69	0.41
3:A:36:GLY:HA3	11:A:301:HEM:C3A	2.55	0.41
2:L:28:GLU:HB3	2:L:576:CYS:HA	2.03	0.41
2:L:106:ILE:O	2:L:110:MET:HG2	2.21	0.41
2:L:540:ASP:HB2	2:L:541:PRO:CD	2.51	0.41
2:L:561:GLU:CD	2:L:561:GLU:H	2.24	0.41
2:J:197:GLU:CD	2:J:197:GLU:H	2.24	0.41
2:J:536:ALA:HB2	2:J:548:TYR:CE2	2.56	0.41
2:L:4:GLN:HA	2:L:12:ILE:O	2.20	0.41
2:K:135:LEU:HD13	2:K:187:TRP:CD1	2.56	0.41
1:S:25:ILE:O	2:L:213:GLN:NE2	2.54	0.40
2:M:65:PRO:HA	2:M:523:ILE:HD11	2.03	0.40
2:J:465:LYS:HD3	2:J:465:LYS:HA	1.95	0.40
2:K:321:MET:HA	2:K:322:PRO:HD3	1.94	0.40
1:T:22:GLU:O	1:T:26:ARG:HG2	2.21	0.40
1:T:226:THR:HG23	1:T:254:GLU:HG2	2.04	0.40
1:T:275:THR:C	1:T:276:HIS:HD1	2.23	0.40
2:M:393:GLU:HB3	12:M:783:HOH:O	2.21	0.40
1:Q:189:LYS:HD2	1:R:191:TYR:CD2	2.56	0.40
2:J:144:LYS:HB3	2:J:197:GLU:HG2	2.03	0.40
2:J:478:LYS:HE2	1:R:165:THR:CG2	2.51	0.40
2:J:574:ASP:N	2:J:575:PRO:HD3	2.36	0.40
1:S:174:ARG:HH11	2:K:488:GLU:CD	2.25	0.40
2:M:413:LEU:CD1	2:M:445:ILE:HG23	2.51	0.40
1:Q:193:ARG:HD2	1:Q:193:ARG:HA	1.92	0.40
2:J:31:MET:HB2	2:J:577:LEU:HG	2.02	0.40
1:R:187:HIS:CB	1:R:224:PRO:HA	2.51	0.40
1:R:193:ARG:HA	1:R:193:ARG:HD2	1.92	0.40
1:S:125:ARG:HA	1:S:126:PRO:HA	1.71	0.40
2:L:20:VAL:HG22	2:L:34:GLU:HG2	2.02	0.40
2:L:60:LEU:HA	2:L:63:ARG:HG3	2.03	0.40
1:T:297:HIS:CD2	1:T:297:HIS:C	2.94	0.40
1:Q:7:ILE:HA	1:Q:8:PRO:HD3	1.93	0.40
2:J:76:CYS:HB3	2:J:79:CYS:SG	2.62	0.40
2:J:341:ASP:HA	2:J:342:PRO:HD3	1.93	0.40
1:S:233:THR:O	1:S:234:ARG:HB2	2.20	0.40
2:L:465:LYS:HD3	2:L:465:LYS:HA	1.95	0.40
3:A:139:MET:HA	3:A:139:MET:CE	2.51	0.40

There are no symmetry-related clashes.

5.3 Torsion angles

5.3.1 Protein backbone

In the following table, the Percentiles column shows the percent Ramachandran outliers of the chain as a percentile score with respect to all X-ray entries followed by that with respect to entries of similar resolution.

The Analysed column shows the number of residues for which the backbone conformation was analysed, and the total number of residues.

Mol	Chain	Analysed	Favoured	Allowed	Outliers	Percentiles	
1	Q	293/335 (88%)	280 (96%)	13 (4%)	0	100	100
1	R	289/335 (86%)	275 (95%)	13 (4%)	1 (0%)	41	61
1	S	294/335 (88%)	280 (95%)	14 (5%)	0	100	100
1	T	294/335 (88%)	279 (95%)	14 (5%)	1 (0%)	41	61
2	J	579/582 (100%)	558 (96%)	21 (4%)	0	100	100
2	K	579/582 (100%)	562 (97%)	17 (3%)	0	100	100
2	L	580/582 (100%)	564 (97%)	16 (3%)	0	100	100
2	M	579/582 (100%)	560 (97%)	18 (3%)	1 (0%)	47	68
3	A	166/235 (71%)	140 (84%)	24 (14%)	2 (1%)	13	24
3	B	154/235 (66%)	135 (88%)	15 (10%)	4 (3%)	5	8
All	All	3807/4138 (92%)	3633 (95%)	165 (4%)	9 (0%)	47	68

All (9) Ramachandran outliers are listed below:

Mol	Chain	Res	Type
3	A	86	ARG
2	M	488	GLU
3	A	154	HIS
3	B	201	MET
1	R	272	GLN
3	B	158	ALA
1	T	298	ALA
3	B	128	ILE
3	B	199	VAL

5.3.2 Protein sidechains [i](#)

In the following table, the Percentiles column shows the percent sidechain outliers of the chain as a percentile score with respect to all X-ray entries followed by that with respect to entries of similar resolution.

The Analysed column shows the number of residues for which the sidechain conformation was analysed, and the total number of residues.

Mol	Chain	Analysed	Rotameric	Outliers	Percentiles	
1	Q	235/273 (86%)	231 (98%)	4 (2%)	60	82
1	R	231/273 (85%)	228 (99%)	3 (1%)	69	87
1	S	236/273 (86%)	233 (99%)	3 (1%)	69	87
1	T	230/273 (84%)	227 (99%)	3 (1%)	69	87
2	J	474/481 (98%)	471 (99%)	3 (1%)	86	95
2	K	474/481 (98%)	472 (100%)	2 (0%)	91	97
2	L	475/481 (99%)	474 (100%)	1 (0%)	93	98
2	M	471/481 (98%)	467 (99%)	4 (1%)	81	93
3	A	114/203 (56%)	110 (96%)	4 (4%)	36	62
3	B	111/203 (55%)	111 (100%)	0	100	100
All	All	3051/3422 (89%)	3024 (99%)	27 (1%)	78	92

All (27) residues with a non-rotameric sidechain are listed below:

Mol	Chain	Res	Type
1	S	16	GLU
1	S	37	LEU
1	S	193	ARG
2	L	472	LYS
1	T	276	HIS
1	T	284	LEU
1	T	289	VAL
2	M	439	ASN
2	M	445	ILE
2	M	487	THR
2	M	579	CYS
1	Q	16	GLU
1	Q	232	SER
1	Q	266	ARG
1	Q	275	THR
2	J	269	ASP

Continued on next page...

Continued from previous page...

Mol	Chain	Res	Type
2	J	429	GLU
2	J	525	LEU
1	R	232	SER
1	R	252	CYS
1	R	277	SER
2	K	269	ASP
2	K	579	CYS
3	A	87	TYR
3	A	108	GLU
3	A	188	MET
3	A	203	LEU

Sometimes sidechains can be flipped to improve hydrogen bonding and reduce clashes. All (9) such sidechains are listed below:

Mol	Chain	Res	Type
2	L	184	ASN
1	T	244	GLN
1	T	297	HIS
2	M	457	HIS
1	Q	244	GLN
2	J	446	GLN
2	J	457	HIS
2	J	562	GLN
2	K	446	GLN

5.3.3 RNA [i](#)

There are no RNA molecules in this entry.

5.4 Non-standard residues in protein, DNA, RNA chains [i](#)

There are no non-standard protein/DNA/RNA residues in this entry.

5.5 Carbohydrates [i](#)

There are no monosaccharides in this entry.

5.6 Ligand geometry

Of 30 ligands modelled in this entry, 12 are monoatomic - leaving 18 for Mogul analysis.

In the following table, the Counts columns list the number of bonds (or angles) for which Mogul statistics could be retrieved, the number of bonds (or angles) that are observed in the model and the number of bonds (or angles) that are defined in the Chemical Component Dictionary. The Link column lists molecule types, if any, to which the group is linked. The Z score for a bond length (or angle) is the number of standard deviations the observed value is removed from the expected value. A bond length (or angle) with $|Z| > 2$ is considered an outlier worth inspection. RMSZ is the root-mean-square of all Z scores of the bond lengths (or angles).

Mol	Type	Chain	Res	Link	Bond lengths			Bond angles		
					Counts	RMSZ	# Z > 2	Counts	RMSZ	# Z > 2
7	FCO	K	601	2,12	0,6,6	-	-	-		
7	FCO	M	601	2,12	0,6,6	-	-	-		
6	ER2	Q	403	1	0,11,11	-	-	-		
4	SF4	R	401	1	0,12,12	-	-	-		
4	SF4	T	401	1	0,12,12	-	-	-		
6	ER2	S	403	1	0,11,11	-	-	-		
4	SF4	Q	401	1	0,12,12	-	-	-		
5	F3S	Q	402	1	0,9,9	-	-	-		
6	ER2	T	403	1	0,11,11	-	-	-		
11	HEM	B	301	3	41,50,50	1.48	7 (17%)	45,82,82	1.97	11 (24%)
11	HEM	A	301	3	41,50,50	1.49	10 (24%)	45,82,82	1.55	8 (17%)
5	F3S	R	402	1	0,9,9	-	-	-		
4	SF4	S	401	1	0,12,12	-	-	-		
7	FCO	J	601	2,12	0,6,6	-	-	-		
7	FCO	L	601	2,12	0,6,6	-	-	-		
6	ER2	R	403	1	0,11,11	-	-	-		
5	F3S	T	402	1	0,9,9	-	-	-		
5	F3S	S	402	1	0,9,9	-	-	-		

In the following table, the Chirals column lists the number of chiral outliers, the number of chiral centers analysed, the number of these observed in the model and the number defined in the Chemical Component Dictionary. Similar counts are reported in the Torsion and Rings columns. '-' means no outliers of that kind were identified.

Mol	Type	Chain	Res	Link	Chirals	Torsions	Rings
6	ER2	Q	403	1	-	-	0/4/4/4
4	SF4	R	401	1	-	-	0/6/5/5
4	SF4	T	401	1	-	-	0/6/5/5
6	ER2	S	403	1	-	-	0/4/4/4
4	SF4	Q	401	1	-	-	0/6/5/5
5	F3S	Q	402	1	-	-	0/3/3/3

Continued on next page...

Continued from previous page...

Mol	Type	Chain	Res	Link	Chirals	Torsions	Rings
6	ER2	T	403	1	-	-	0/4/4/4
5	F3S	R	402	1	-	-	0/3/3/3
4	SF4	S	401	1	-	-	0/6/5/5
6	ER2	R	403	1	-	-	0/4/4/4
11	HEM	B	301	3	-	7/12/54/54	-
11	HEM	A	301	3	-	6/12/54/54	-
5	F3S	T	402	1	-	-	0/3/3/3
5	F3S	S	402	1	-	-	0/3/3/3

All (17) bond length outliers are listed below:

Mol	Chain	Res	Type	Atoms	Z	Observed(Å)	Ideal(Å)
11	B	301	HEM	C1B-NB	-4.46	1.32	1.40
11	A	301	HEM	C1B-NB	-3.95	1.33	1.40
11	A	301	HEM	C4D-ND	-3.30	1.34	1.40
11	B	301	HEM	C4D-ND	-3.13	1.34	1.40
11	A	301	HEM	C4B-NB	-3.09	1.32	1.38
11	B	301	HEM	C3C-C2C	-2.90	1.36	1.40
11	A	301	HEM	FE-NB	2.81	2.10	1.96
11	B	301	HEM	C1D-ND	-2.68	1.33	1.38
11	A	301	HEM	C3C-C2C	-2.57	1.36	1.40
11	B	301	HEM	FE-NB	2.41	2.08	1.96
11	B	301	HEM	FE-ND	-2.36	1.85	1.96
11	A	301	HEM	FE-ND	-2.35	1.85	1.96
11	B	301	HEM	C1B-C2B	-2.29	1.40	1.44
11	A	301	HEM	CHB-C1B	2.15	1.40	1.35
11	A	301	HEM	O2D-CGD	-2.08	1.23	1.30
11	A	301	HEM	O2A-CGA	-2.08	1.23	1.30
11	A	301	HEM	C1D-ND	-2.02	1.34	1.38

All (19) bond angle outliers are listed below:

Mol	Chain	Res	Type	Atoms	Z	Observed(°)	Ideal(°)
11	B	301	HEM	CHC-C4B-NB	6.25	131.22	124.43
11	A	301	HEM	CHC-C4B-NB	4.50	129.32	124.43
11	B	301	HEM	C1B-NB-C4B	3.75	108.95	105.07
11	B	301	HEM	CHD-C1D-ND	3.68	128.43	124.43
11	A	301	HEM	CHD-C1D-ND	3.55	128.28	124.43
11	B	301	HEM	CHA-C4D-ND	3.31	128.47	124.38
11	B	301	HEM	CHD-C1D-C2D	-3.27	119.87	124.98
11	A	301	HEM	C1B-NB-C4B	3.21	108.39	105.07
11	A	301	HEM	CHD-C1D-C2D	-3.03	120.25	124.98

Continued on next page...

Continued from previous page...

Mol	Chain	Res	Type	Atoms	Z	Observed(°)	Ideal(°)
11	B	301	HEM	O2D-CGD-O1D	-3.00	115.83	123.30
11	B	301	HEM	CHB-C1B-NB	2.83	127.88	124.38
11	A	301	HEM	CHA-C4D-ND	2.77	127.80	124.38
11	B	301	HEM	CHA-C4D-C3D	-2.75	120.17	125.33
11	B	301	HEM	O2D-CGD-CBD	2.66	122.58	114.03
11	B	301	HEM	CAD-C3D-C2D	2.50	132.54	127.88
11	A	301	HEM	O2A-CGA-O1A	-2.27	117.65	123.30
11	B	301	HEM	CHC-C4B-C3B	-2.25	121.12	124.57
11	A	301	HEM	CHA-C4D-C3D	-2.19	121.21	125.33
11	A	301	HEM	O2D-CGD-O1D	-2.11	118.04	123.30

There are no chirality outliers.

All (13) torsion outliers are listed below:

Mol	Chain	Res	Type	Atoms
11	B	301	HEM	C2D-C3D-CAD-CBD
11	B	301	HEM	C4D-C3D-CAD-CBD
11	A	301	HEM	C4D-C3D-CAD-CBD
11	A	301	HEM	C2D-C3D-CAD-CBD
11	B	301	HEM	C3D-CAD-CBD-CGD
11	B	301	HEM	CAD-CBD-CGD-O1D
11	B	301	HEM	CAD-CBD-CGD-O2D
11	A	301	HEM	CAD-CBD-CGD-O1D
11	A	301	HEM	CAD-CBD-CGD-O2D
11	A	301	HEM	CAA-CBA-CGA-O2A
11	A	301	HEM	CAA-CBA-CGA-O1A
11	B	301	HEM	CAA-CBA-CGA-O2A
11	B	301	HEM	CAA-CBA-CGA-O1A

There are no ring outliers.

1 monomer is involved in 5 short contacts:

Mol	Chain	Res	Type	Clashes	Symm-Clashes
11	A	301	HEM	5	0

The following is a two-dimensional graphical depiction of Mogul quality analysis of bond lengths, bond angles, torsion angles, and ring geometry for all instances of the Ligand of Interest. In addition, ligands with molecular weight > 250 and outliers as shown on the validation Tables will also be included. For torsion angles, if less than 5% of the Mogul distribution of torsion angles is within 10 degrees of the torsion angle in question, then that torsion angle is considered an outlier. Any bond that is central to one or more torsion angles identified as an outlier by Mogul will be highlighted in the graph. For rings, the root-mean-square deviation (RMSD) between the ring

in question and similar rings identified by Mogul is calculated over all ring torsion angles. If the average RMSD is greater than 60 degrees and the minimal RMSD between the ring in question and any Mogul-identified rings is also greater than 60 degrees, then that ring is considered an outlier. The outliers are highlighted in purple. The color gray indicates Mogul did not find sufficient equivalents in the CSD to analyse the geometry.

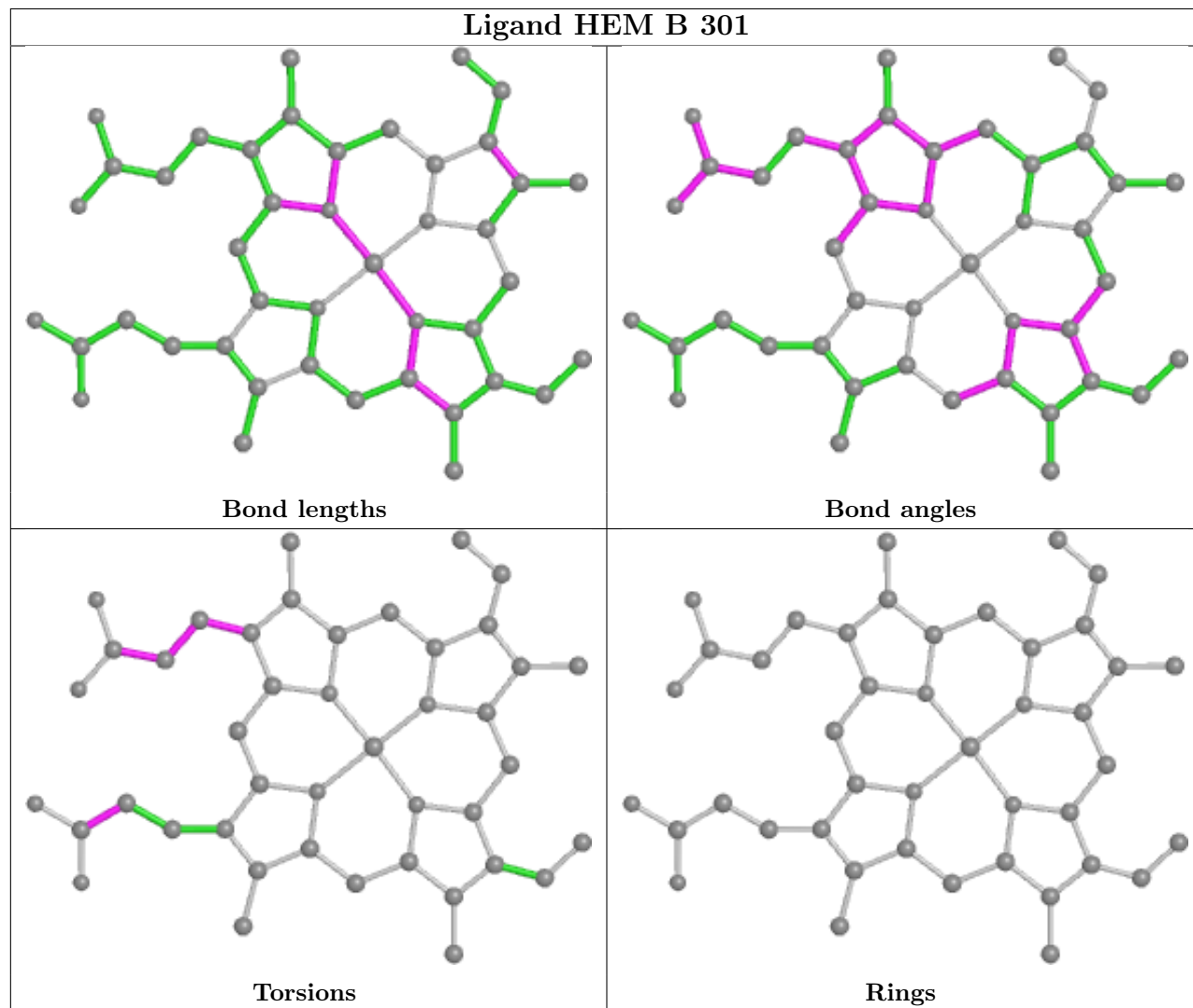

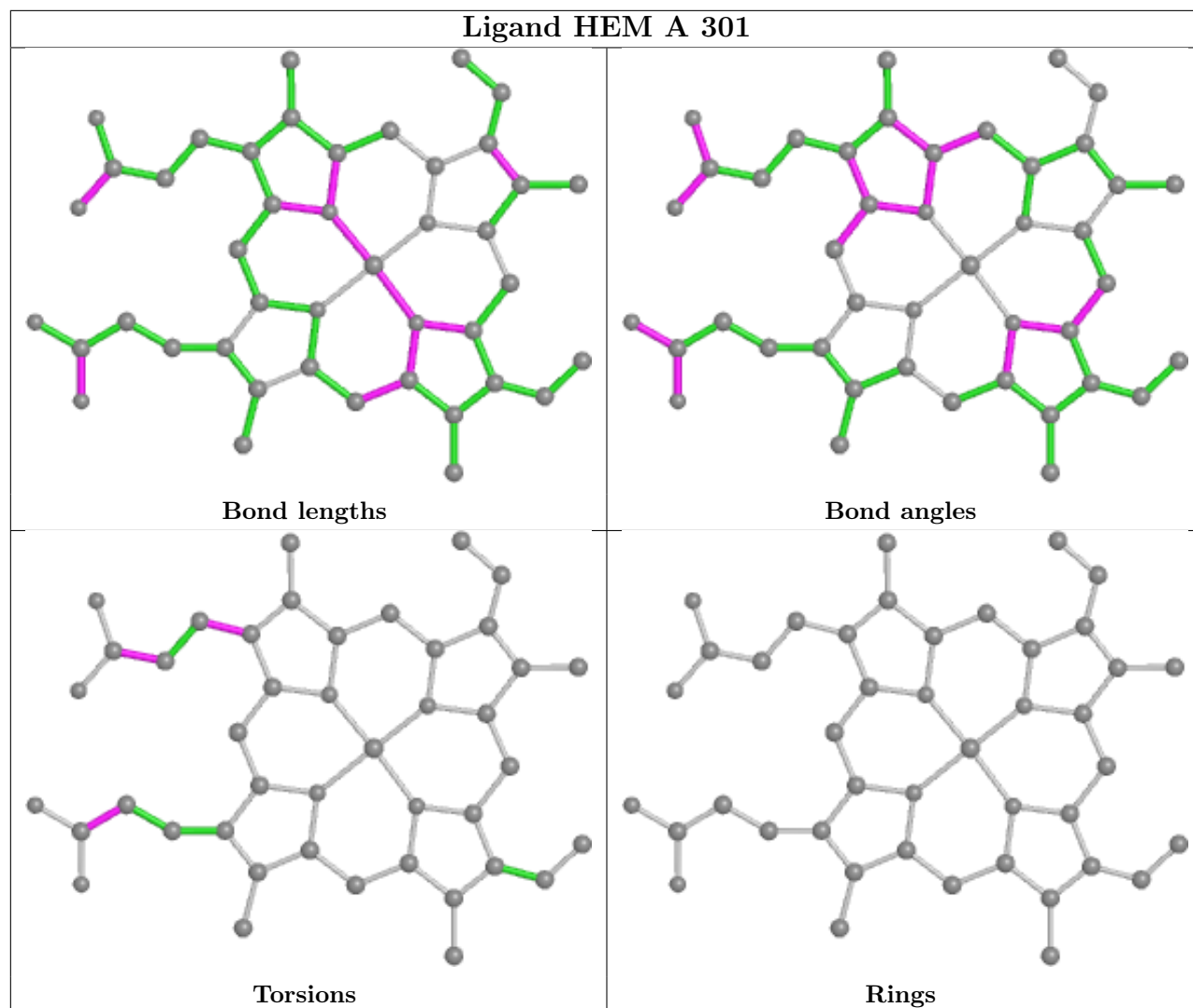

5.7 Other polymers [i](#)

There are no such residues in this entry.

5.8 Polymer linkage issues [i](#)

There are no chain breaks in this entry.

6 Fit of model and data [i](#)

6.1 Protein, DNA and RNA chains [i](#)

In the following table, the column labelled ‘#RSRZ > 2’ contains the number (and percentage) of RSRZ outliers, followed by percent RSRZ outliers for the chain as percentile scores relative to all X-ray entries and entries of similar resolution. The OWAB column contains the minimum, median, 95th percentile and maximum values of the occupancy-weighted average B-factor per residue. The column labelled ‘Q < 0.9’ lists the number of (and percentage) of residues with an average occupancy less than 0.9.

Mol	Chain	Analysed	<RSRZ>	#RSRZ>2	OWAB(Å ²)	Q<0.9
1	Q	295/335 (88%)	-0.08	5 (1%) 70 72	38, 48, 64, 87	0
1	R	291/335 (86%)	0.46	32 (10%) 5 5	38, 52, 73, 101	0
1	S	296/335 (88%)	-0.18	3 (1%) 82 84	33, 43, 62, 87	0
1	T	296/335 (88%)	0.26	15 (5%) 28 29	35, 51, 76, 117	0
2	J	581/582 (99%)	0.01	3 (0%) 91 91	40, 52, 66, 78	0
2	K	581/582 (99%)	0.04	19 (3%) 46 50	37, 49, 65, 85	0
2	L	581/582 (99%)	-0.09	6 (1%) 82 84	34, 46, 59, 76	0
2	M	581/582 (99%)	0.19	23 (3%) 38 41	36, 52, 70, 85	0
3	A	172/235 (73%)	0.69	34 (19%) 1 1	40, 61, 102, 112	0
3	B	160/235 (68%)	0.78	35 (21%) 0 0	45, 62, 106, 132	0
All	All	3834/4138 (92%)	0.12	175 (4%) 32 34	33, 50, 73, 132	0

All (175) RSRZ outliers are listed below:

Mol	Chain	Res	Type	RSRZ
3	B	155	SER	6.5
1	R	7	ILE	6.0
3	A	201	MET	5.9
3	B	109	ILE	5.6
3	B	102	TRP	5.4
3	A	82	PHE	5.3
3	B	128	ILE	5.0
1	R	292	ALA	4.9
3	A	203	LEU	4.7
3	B	83	VAL	4.7
3	A	157	TYR	4.6
3	B	131	ALA	4.6
3	B	165	TYR	4.6

Continued on next page...

Continued from previous page...

Mol	Chain	Res	Type	RSRZ
2	K	175	GLU	4.5
2	M	164	PHE	4.5
2	M	334	VAL	4.5
3	A	200	TYR	4.4
3	B	157	TYR	4.2
3	A	202	ALA	4.2
3	B	162	PRO	4.1
1	S	3	ASN	4.0
3	B	80	TRP	4.0
2	M	335	LEU	3.9
1	R	293	ALA	3.8
3	B	129	ALA	3.8
1	R	291	ALA	3.8
3	A	134	PHE	3.7
1	R	67	TYR	3.7
3	B	134	PHE	3.7
1	T	296	VAL	3.7
1	R	69	GLY	3.7
1	T	294	VAL	3.5
3	B	197	GLY	3.5
2	M	424	ASP	3.4
3	A	155	SER	3.4
3	A	199	VAL	3.4
2	M	518	ILE	3.4
3	B	23	TRP	3.4
2	M	428	VAL	3.4
1	R	23	SER	3.3
3	B	112	TYR	3.3
3	A	102	TRP	3.3
3	A	131	ALA	3.2
3	A	204	ARG	3.2
3	B	161	ALA	3.2
1	R	47	THR	3.2
1	R	149	CYS	3.2
3	B	198	HIS	3.2
1	R	290	VAL	3.2
3	A	106	TRP	3.2
2	L	15	ALA	3.1
3	A	101	TRP	3.1
3	B	164	ARG	3.1
1	T	295	GLY	3.1
2	J	235	GLY	3.1

Continued on next page...

Continued from previous page...

Mol	Chain	Res	Type	RSRZ
3	B	132	ALA	3.1
1	R	25	ILE	3.0
3	B	17	PRO	3.0
1	R	21	THR	3.0
3	B	81	ALA	3.0
2	M	425	ALA	3.0
3	A	162	PRO	3.0
1	R	70	LYS	3.0
1	R	235	TRP	3.0
3	A	207	ILE	2.9
3	B	103	GLN	2.9
2	M	420	TYR	2.9
1	R	66	GLN	2.8
3	B	101	TRP	2.8
2	M	333	ASN	2.8
3	A	80	TRP	2.8
2	K	190	PRO	2.8
3	B	113	LEU	2.8
3	A	133	MET	2.8
1	R	8	PRO	2.8
3	A	21	TRP	2.8
1	Q	124	ALA	2.8
2	M	221	ALA	2.8
3	A	132	ALA	2.8
2	M	337	VAL	2.8
2	M	77	GLY	2.8
3	B	82	PHE	2.8
2	L	310	ILE	2.7
1	R	20	CYS	2.7
2	K	176	GLY	2.7
2	K	146	SER	2.7
3	A	104	GLY	2.7
2	K	11	THR	2.7
2	J	236	GLY	2.7
1	R	141	LYS	2.6
3	B	21	TRP	2.6
1	R	107	SER	2.6
2	K	217	VAL	2.6
1	R	153	PRO	2.6
1	T	273	MET	2.6
2	K	193	LYS	2.6
1	T	17	CYS	2.6

Continued on next page...

Continued from previous page...

Mol	Chain	Res	Type	RSRZ
2	K	496	PRO	2.5
3	A	127	PRO	2.5
1	R	139	THR	2.5
2	K	160	PRO	2.5
3	B	106	TRP	2.5
2	M	222	VAL	2.5
2	K	140	ALA	2.5
2	M	217	VAL	2.5
3	A	108	GLU	2.5
3	A	165	TYR	2.5
3	B	20	ILE	2.5
2	M	230	PRO	2.5
1	R	16	GLU	2.5
2	M	229	HIS	2.4
2	M	226	LYS	2.4
3	A	100	SER	2.4
1	R	289	VAL	2.4
3	A	126	ASN	2.4
2	J	221	ALA	2.4
3	A	129	ALA	2.4
1	T	150	PRO	2.4
1	T	149	CYS	2.4
2	K	164	PHE	2.3
2	K	145	THR	2.3
3	B	79	TYR	2.3
1	T	26	ARG	2.3
1	S	203	GLN	2.3
2	K	121	VAL	2.3
1	T	235	TRP	2.3
1	Q	5	PRO	2.3
2	K	489	LYS	2.2
2	L	420	TYR	2.2
1	R	68	ASN	2.2
3	B	130	GLN	2.2
1	R	152	ILE	2.2
3	B	202	ALA	2.2
3	B	194	PHE	2.2
1	R	167	ASP	2.2
3	A	79	TYR	2.2
1	T	291	ALA	2.2
2	M	560	PRO	2.2
2	K	227	ASN	2.2

Continued on next page...

Continued from previous page...

Mol	Chain	Res	Type	RSRZ
2	M	224	GLY	2.2
3	B	108	GLU	2.2
2	M	499	CYS	2.2
1	Q	239	VAL	2.1
1	T	274	GLY	2.1
2	M	498	GLU	2.1
2	K	163	PHE	2.1
1	T	92	GLY	2.1
2	K	139	LYS	2.1
1	R	19	GLY	2.1
1	S	270	ILE	2.1
1	R	142	PRO	2.1
2	L	333	ASN	2.1
2	L	176	GLY	2.1
3	A	16	ALA	2.1
3	B	16	ALA	2.1
2	K	138	LEU	2.1
3	A	164	ARG	2.1
1	Q	70	LYS	2.1
1	Q	269	ASP	2.1
1	T	292	ALA	2.1
1	R	270	ILE	2.1
1	T	277	SER	2.1
2	M	227	ASN	2.1
3	A	205	GLU	2.1
2	K	80	THR	2.0
3	A	107	TYR	2.0
3	B	172	TRP	2.0
3	A	206	ASP	2.0
2	M	228	PRO	2.0
2	L	144	LYS	2.0
1	R	26	ARG	2.0
1	R	234	ARG	2.0
1	R	106	ALA	2.0
1	T	25	ILE	2.0
3	A	112	TYR	2.0

6.2 Non-standard residues in protein, DNA, RNA chains

There are no non-standard protein/DNA/RNA residues in this entry.

6.3 Carbohydrates [i](#)

There are no monosaccharides in this entry.

6.4 Ligands [i](#)

In the following table, the Atoms column lists the number of modelled atoms in the group and the number defined in the chemical component dictionary. The B-factors column lists the minimum, median, 95th percentile and maximum values of B factors of atoms in the group. The column labelled 'Q< 0.9' lists the number of atoms with occupancy less than 0.9.

Mol	Type	Chain	Res	Atoms	RSCC	RSR	B-factors(Å ²)	Q<0.9
10	CL	J	604	1/1	0.64	0.27	43,43,43,43	1
10	CL	K	604	1/1	0.77	0.27	43,43,43,43	1
10	CL	L	604	1/1	0.90	0.27	41,41,41,41	1
10	CL	M	604	1/1	0.90	0.30	35,35,35,35	1
9	MG	L	603	1/1	0.93	0.06	42,42,42,42	0
9	MG	M	603	1/1	0.94	0.08	50,50,50,50	0
9	MG	J	603	1/1	0.97	0.05	44,44,44,44	0
9	MG	K	603	1/1	0.97	0.10	45,45,45,45	0
11	HEM	A	301	43/43	0.97	0.12	47,50,54,59	0
11	HEM	B	301	43/43	0.97	0.11	43,48,54,57	0
7	FCO	J	601	7/7	0.98	0.15	41,41,49,53	0
8	NI	K	602	1/1	0.98	0.08	43,43,43,43	0
5	F3S	S	402	7/7	0.98	0.08	38,40,40,45	0
5	F3S	T	402	7/7	0.98	0.13	40,41,44,47	0
6	ER2	S	403	8/8	0.98	0.08	39,40,42,45	0
6	ER2	R	403	8/8	0.98	0.17	44,47,51,52	0
8	NI	L	602	1/1	0.99	0.12	39,39,39,39	0
8	NI	M	602	1/1	0.99	0.09	44,44,44,44	0
8	NI	J	602	1/1	0.99	0.09	43,43,43,43	0
4	SF4	T	401	8/8	0.99	0.12	39,40,41,45	0
5	F3S	Q	402	7/7	0.99	0.07	39,40,41,42	0
5	F3S	R	402	7/7	0.99	0.14	39,41,42,42	0
4	SF4	Q	401	8/8	0.99	0.08	41,44,46,48	0
6	ER2	T	403	8/8	0.99	0.17	42,43,47,49	0
6	ER2	Q	403	8/8	0.99	0.10	41,44,49,50	0
4	SF4	R	401	8/8	0.99	0.10	40,42,44,45	0
7	FCO	L	601	7/7	0.99	0.14	39,39,46,50	0
7	FCO	M	601	7/7	0.99	0.13	42,45,49,49	0
4	SF4	S	401	8/8	0.99	0.09	39,40,41,41	0
7	FCO	K	601	7/7	0.99	0.09	39,41,45,46	0

The following is a graphical depiction of the model fit to experimental electron density of all

instances of the Ligand of Interest. In addition, ligands with molecular weight > 250 and outliers as shown on the geometry validation Tables will also be included. Each fit is shown from different orientation to approximate a three-dimensional view.

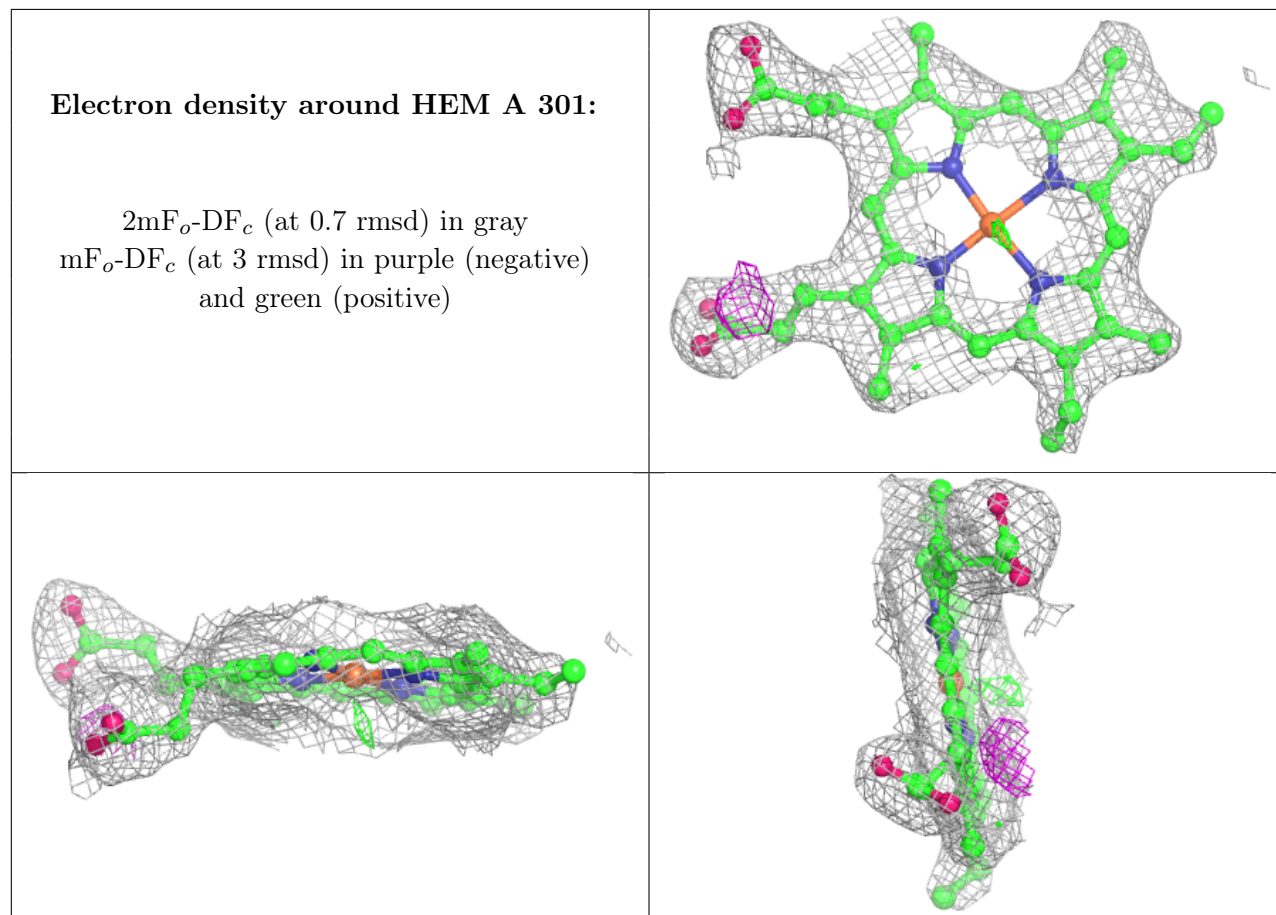

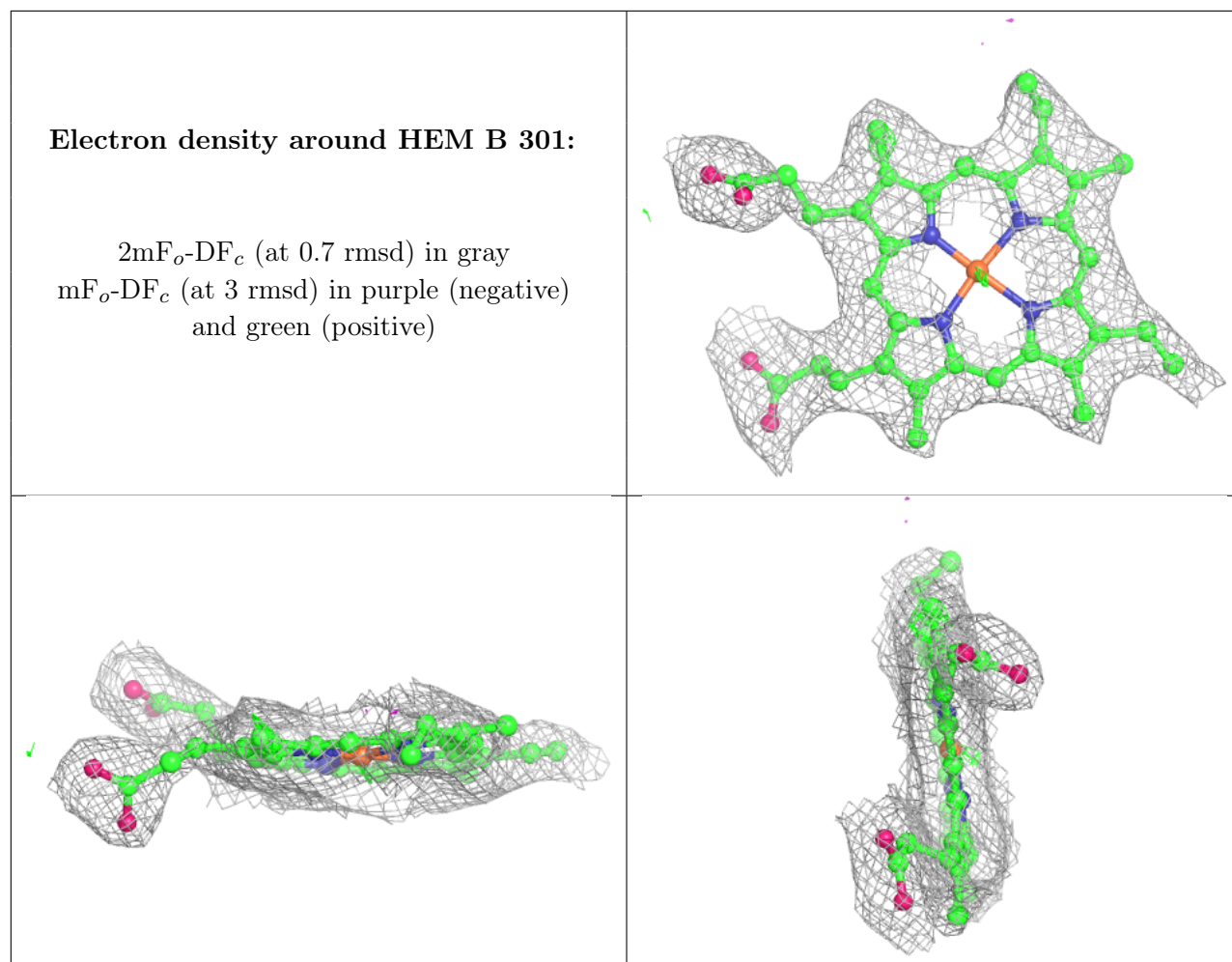

6.5 Other polymers [i](#)

There are no such residues in this entry.