



wwPDB X-ray Structure Validation Summary Report ⓘ

Aug 20, 2023 – 12:56 AM EDT

PDB ID : 2FHH
Title : Crystal Structure of Mycobacterium Tuberculosis Proteasome in complex with a peptidyl boronate inhibitor MLN-273
Authors : Li, H.
Deposited on : 2005-12-23
Resolution : 2.99 Å(reported)

This is a wwPDB X-ray Structure Validation Summary Report for a publicly released PDB entry.

We welcome your comments at validation@mail.wwpdb.org

A user guide is available at

<https://www.wwpdb.org/validation/2017/XrayValidationReportHelp>

with specific help available everywhere you see the ⓘ symbol.

The types of validation reports are described at

<http://www.wwpdb.org/validation/2017/FAQs#types>.

The following versions of software and data (see [references ⓘ](#)) were used in the production of this report:

MolProbity : 4.02b-467
Mogul : 1.8.5 (274361), CSD as541be (2020)
Xtriage (Phenix) : 1.13
EDS : 2.35
buster-report : 1.1.7 (2018)
Percentile statistics : 20191225.v01 (using entries in the PDB archive December 25th 2019)
Refmac : 5.8.0158
CCP4 : 7.0.044 (Gargrove)
Ideal geometry (proteins) : Engh & Huber (2001)
Ideal geometry (DNA, RNA) : Parkinson et al. (1996)
Validation Pipeline (wwPDB-VP) : 2.35

1 Overall quality at a glance

The following experimental techniques were used to determine the structure:

X-RAY DIFFRACTION

The reported resolution of this entry is 2.99 Å.

Percentile scores (ranging between 0-100) for global validation metrics of the entry are shown in the following graphic. The table shows the number of entries on which the scores are based.

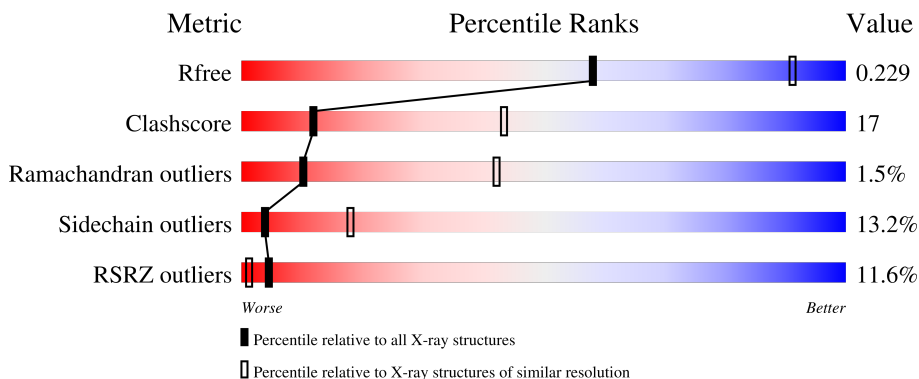











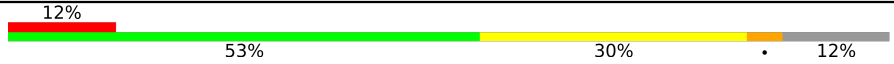



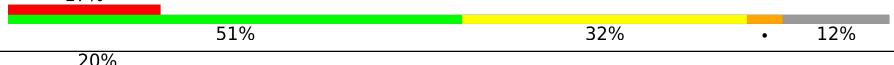
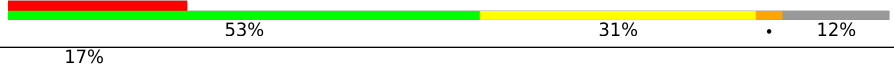

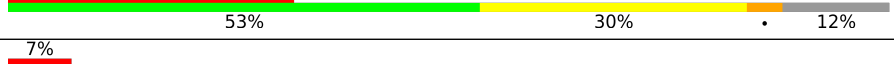
Metric	Whole archive (#Entries)	Similar resolution (#Entries, resolution range(Å))
R_{free}	130704	2092 (3.00-3.00)
Clashscore	141614	2416 (3.00-3.00)
Ramachandran outliers	138981	2333 (3.00-3.00)
Sidechain outliers	138945	2336 (3.00-3.00)
RSRZ outliers	127900	1990 (3.00-3.00)

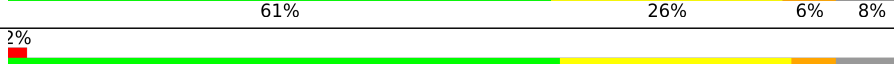
The table below summarises the geometric issues observed across the polymeric chains and their fit to the electron density. The red, orange, yellow and green segments of the lower bar indicate the fraction of residues that contain outliers for ≥ 3 , 2, 1 and 0 types of geometric quality criteria respectively. A grey segment represents the fraction of residues that are not modelled. The numeric value for each fraction is indicated below the corresponding segment, with a dot representing fractions $\leq 5\%$. The upper red bar (where present) indicates the fraction of residues that have poor fit to the electron density. The numeric value is given above the bar.

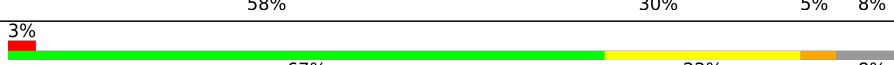
Mol	Chain	Length	Quality of chain
1	1	251	
1	A	251	
1	B	251	
1	D	251	
1	F	251	

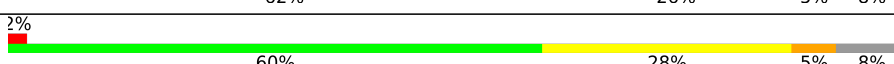
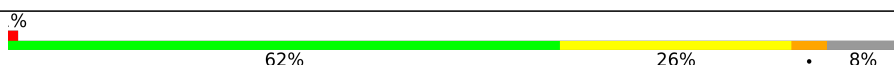
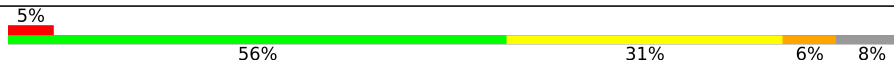
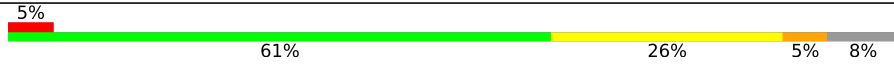
Continued on next page...

Continued from previous page...

Mol	Chain	Length	Quality of chain
1	I	251	
1	K	251	
1	M	251	
1	O	251	
1	Q	251	
1	S	251	
1	U	251	
1	W	251	
1	Y	251	
2	2	240	
2	C	240	
2	E	240	
2	G	240	
2	H	240	
2	J	240	
2	L	240	
2	N	240	
2	P	240	
2	R	240	
2	T	240	
2	V	240	
2	X	240	
2	Z	240	

2 Entry composition [i](#)

There are 4 unique types of molecules in this entry. The entry contains 47389 atoms, of which 0 are hydrogens and 0 are deuteriums.

In the tables below, the ZeroOcc column contains the number of atoms modelled with zero occupancy, the AltConf column contains the number of residues with at least one atom in alternate conformation and the Trace column contains the number of residues modelled with at most 2 atoms.

- Molecule 1 is a protein called 20S proteasome, alpha and beta subunits.

Mol	Chain	Residues	Atoms					ZeroOcc	AltConf	Trace
			Total	C	N	O	S			
1	A	220	1692	1058	309	322	3	0	0	0
1	B	220	1692	1058	309	322	3	0	0	0
1	D	220	1692	1058	309	322	3	0	0	0
1	F	220	1692	1058	309	322	3	0	0	0
1	I	220	1692	1058	309	322	3	0	0	0
1	K	220	1692	1058	309	322	3	0	0	0
1	M	220	1692	1058	309	322	3	0	0	0
1	O	220	1692	1058	309	322	3	0	0	0
1	Q	220	1692	1058	309	322	3	0	0	0
1	S	220	1692	1058	309	322	3	0	0	0
1	U	220	1692	1058	309	322	3	0	0	0
1	W	220	1692	1058	309	322	3	0	0	0
1	Y	220	1692	1058	309	322	3	0	0	0
1	1	220	1692	1058	309	322	3	0	0	0

There are 56 discrepancies between the modelled and reference sequences:

Chain	Residue	Modelled	Actual	Comment	Reference
A	-2	MET	-	initiating methionine	GB 76783992

Continued on next page...

Continued from previous page...

Chain	Residue	Modelled	Actual	Comment	Reference
A	-1	ASN	-	cloning artifact	GB 76783992
A	0	SER	-	cloning artifact	GB 76783992
A	1	SER	-	cloning artifact	GB 76783992
B	-2	MET	-	initiating methionine	GB 76783992
B	-1	ASN	-	cloning artifact	GB 76783992
B	0	SER	-	cloning artifact	GB 76783992
B	1	SER	-	cloning artifact	GB 76783992
D	-2	MET	-	initiating methionine	GB 76783992
D	-1	ASN	-	cloning artifact	GB 76783992
D	0	SER	-	cloning artifact	GB 76783992
D	1	SER	-	cloning artifact	GB 76783992
F	-2	MET	-	initiating methionine	GB 76783992
F	-1	ASN	-	cloning artifact	GB 76783992
F	0	SER	-	cloning artifact	GB 76783992
F	1	SER	-	cloning artifact	GB 76783992
I	-2	MET	-	initiating methionine	GB 76783992
I	-1	ASN	-	cloning artifact	GB 76783992
I	0	SER	-	cloning artifact	GB 76783992
I	1	SER	-	cloning artifact	GB 76783992
K	-2	MET	-	initiating methionine	GB 76783992
K	-1	ASN	-	cloning artifact	GB 76783992
K	0	SER	-	cloning artifact	GB 76783992
K	1	SER	-	cloning artifact	GB 76783992
M	-2	MET	-	initiating methionine	GB 76783992
M	-1	ASN	-	cloning artifact	GB 76783992
M	0	SER	-	cloning artifact	GB 76783992
M	1	SER	-	cloning artifact	GB 76783992
O	-2	MET	-	initiating methionine	GB 76783992
O	-1	ASN	-	cloning artifact	GB 76783992
O	0	SER	-	cloning artifact	GB 76783992
O	1	SER	-	cloning artifact	GB 76783992
Q	-2	MET	-	initiating methionine	GB 76783992
Q	-1	ASN	-	cloning artifact	GB 76783992
Q	0	SER	-	cloning artifact	GB 76783992
Q	1	SER	-	cloning artifact	GB 76783992
S	-2	MET	-	initiating methionine	GB 76783992
S	-1	ASN	-	cloning artifact	GB 76783992
S	0	SER	-	cloning artifact	GB 76783992
S	1	SER	-	cloning artifact	GB 76783992
U	-2	MET	-	initiating methionine	GB 76783992
U	-1	ASN	-	cloning artifact	GB 76783992
U	0	SER	-	cloning artifact	GB 76783992

Continued on next page...

Continued from previous page...

Chain	Residue	Modelled	Actual	Comment	Reference
U	1	SER	-	cloning artifact	GB 76783992
W	-2	MET	-	initiating methionine	GB 76783992
W	-1	ASN	-	cloning artifact	GB 76783992
W	0	SER	-	cloning artifact	GB 76783992
W	1	SER	-	cloning artifact	GB 76783992
Y	-2	MET	-	initiating methionine	GB 76783992
Y	-1	ASN	-	cloning artifact	GB 76783992
Y	0	SER	-	cloning artifact	GB 76783992
Y	1	SER	-	cloning artifact	GB 76783992
1	-2	MET	-	initiating methionine	GB 76783992
1	-1	ASN	-	cloning artifact	GB 76783992
1	0	SER	-	cloning artifact	GB 76783992
1	1	SER	-	cloning artifact	GB 76783992

- Molecule 2 is a protein called proteasome, beta subunit.

Mol	Chain	Residues	Atoms					ZeroOcc	AltConf	Trace
			Total	C	N	O	S			
2	H	222	1638	1027	282	324	5	0	0	0
2	C	222	1638	1027	282	324	5	0	0	0
2	E	222	1638	1027	282	324	5	0	0	0
2	G	222	1638	1027	282	324	5	0	0	0
2	J	222	1638	1027	282	324	5	0	0	0
2	L	222	1638	1027	282	324	5	0	0	0
2	N	222	1638	1027	282	324	5	0	0	0
2	P	222	1638	1027	282	324	5	0	0	0
2	R	222	1638	1027	282	324	5	0	0	0
2	T	222	1638	1027	282	324	5	0	0	0
2	V	222	1638	1027	282	324	5	0	0	0
2	X	222	1638	1027	282	324	5	0	0	0
2	Z	222	1638	1027	282	324	5	0	0	0

Continued on next page...

Continued from previous page...

Mol	Chain	Residues	Atoms					ZeroOcc	AltConf	Trace
			Total	C	N	O	S			
2	2	222	1638	1027	282	324	5	0	0	0

There are 84 discrepancies between the modelled and reference sequences:

Chain	Residue	Modelled	Actual	Comment	Reference
H	535	HIS	-	expression tag	GB 13881852
H	536	HIS	-	expression tag	GB 13881852
H	537	HIS	-	expression tag	GB 13881852
H	538	HIS	-	expression tag	GB 13881852
H	539	HIS	-	expression tag	GB 13881852
H	540	HIS	-	expression tag	GB 13881852
C	535	HIS	-	expression tag	GB 13881852
C	536	HIS	-	expression tag	GB 13881852
C	537	HIS	-	expression tag	GB 13881852
C	538	HIS	-	expression tag	GB 13881852
C	539	HIS	-	expression tag	GB 13881852
C	540	HIS	-	expression tag	GB 13881852
E	535	HIS	-	expression tag	GB 13881852
E	536	HIS	-	expression tag	GB 13881852
E	537	HIS	-	expression tag	GB 13881852
E	538	HIS	-	expression tag	GB 13881852
E	539	HIS	-	expression tag	GB 13881852
E	540	HIS	-	expression tag	GB 13881852
G	535	HIS	-	expression tag	GB 13881852
G	536	HIS	-	expression tag	GB 13881852
G	537	HIS	-	expression tag	GB 13881852
G	538	HIS	-	expression tag	GB 13881852
G	539	HIS	-	expression tag	GB 13881852
G	540	HIS	-	expression tag	GB 13881852
J	535	HIS	-	expression tag	GB 13881852
J	536	HIS	-	expression tag	GB 13881852
J	537	HIS	-	expression tag	GB 13881852
J	538	HIS	-	expression tag	GB 13881852
J	539	HIS	-	expression tag	GB 13881852
J	540	HIS	-	expression tag	GB 13881852
L	535	HIS	-	expression tag	GB 13881852
L	536	HIS	-	expression tag	GB 13881852
L	537	HIS	-	expression tag	GB 13881852
L	538	HIS	-	expression tag	GB 13881852
L	539	HIS	-	expression tag	GB 13881852
L	540	HIS	-	expression tag	GB 13881852

Continued on next page...

Continued from previous page...

Chain	Residue	Modelled	Actual	Comment	Reference
N	535	HIS	-	expression tag	GB 13881852
N	536	HIS	-	expression tag	GB 13881852
N	537	HIS	-	expression tag	GB 13881852
N	538	HIS	-	expression tag	GB 13881852
N	539	HIS	-	expression tag	GB 13881852
N	540	HIS	-	expression tag	GB 13881852
P	535	HIS	-	expression tag	GB 13881852
P	536	HIS	-	expression tag	GB 13881852
P	537	HIS	-	expression tag	GB 13881852
P	538	HIS	-	expression tag	GB 13881852
P	539	HIS	-	expression tag	GB 13881852
P	540	HIS	-	expression tag	GB 13881852
R	535	HIS	-	expression tag	GB 13881852
R	536	HIS	-	expression tag	GB 13881852
R	537	HIS	-	expression tag	GB 13881852
R	538	HIS	-	expression tag	GB 13881852
R	539	HIS	-	expression tag	GB 13881852
R	540	HIS	-	expression tag	GB 13881852
T	535	HIS	-	expression tag	GB 13881852
T	536	HIS	-	expression tag	GB 13881852
T	537	HIS	-	expression tag	GB 13881852
T	538	HIS	-	expression tag	GB 13881852
T	539	HIS	-	expression tag	GB 13881852
T	540	HIS	-	expression tag	GB 13881852
V	535	HIS	-	expression tag	GB 13881852
V	536	HIS	-	expression tag	GB 13881852
V	537	HIS	-	expression tag	GB 13881852
V	538	HIS	-	expression tag	GB 13881852
V	539	HIS	-	expression tag	GB 13881852
V	540	HIS	-	expression tag	GB 13881852
X	535	HIS	-	expression tag	GB 13881852
X	536	HIS	-	expression tag	GB 13881852
X	537	HIS	-	expression tag	GB 13881852
X	538	HIS	-	expression tag	GB 13881852
X	539	HIS	-	expression tag	GB 13881852
X	540	HIS	-	expression tag	GB 13881852
Z	535	HIS	-	expression tag	GB 13881852
Z	536	HIS	-	expression tag	GB 13881852
Z	537	HIS	-	expression tag	GB 13881852
Z	538	HIS	-	expression tag	GB 13881852
Z	539	HIS	-	expression tag	GB 13881852
Z	540	HIS	-	expression tag	GB 13881852

Continued on next page...

Continued from previous page...

Chain	Residue	Modelled	Actual	Comment	Reference
2	535	HIS	-	expression tag	GB 13881852
2	536	HIS	-	expression tag	GB 13881852
2	537	HIS	-	expression tag	GB 13881852
2	538	HIS	-	expression tag	GB 13881852
2	539	HIS	-	expression tag	GB 13881852
2	540	HIS	-	expression tag	GB 13881852

- Molecule 3 is (1R)-3-METHYL-1-[[N-(MORPHOLIN-4-YLCARBONYL)-3-(1-NAPHTHYL)-D-ALANYL]AMINO]BUTYLBORONIC ACID (three-letter code: M1N) (formula: C₂₃H₃₂BN₃O₅).

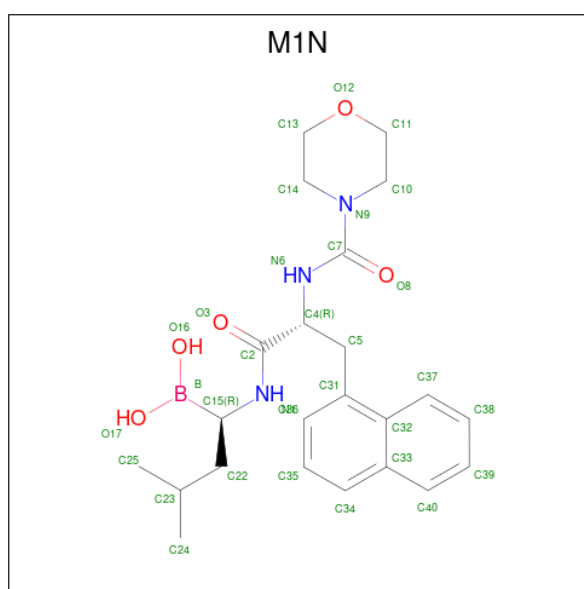

Mol	Chain	Residues	Atoms					ZeroOcc	AltConf
			Total	B	C	N	O		
3	H	1	Total 32	B 1	C 23	N 3	O 5	0	0
3	C	1	Total 32	B 1	C 23	N 3	O 5	0	0
3	E	1	Total 32	B 1	C 23	N 3	O 5	0	0
3	G	1	Total 32	B 1	C 23	N 3	O 5	0	0
3	J	1	Total 32	B 1	C 23	N 3	O 5	0	0
3	L	1	Total 32	B 1	C 23	N 3	O 5	0	0
3	N	1	Total 32	B 1	C 23	N 3	O 5	0	0

Continued on next page...

Continued from previous page...

Mol	Chain	Residues	Atoms					ZeroOcc	AltConf
3	P	1	Total	B	C	N	O	0	0
			32	1	23	3	5		
3	R	1	Total	B	C	N	O	0	0
			32	1	23	3	5		
3	T	1	Total	B	C	N	O	0	0
			32	1	23	3	5		
3	V	1	Total	B	C	N	O	0	0
			32	1	23	3	5		
3	X	1	Total	B	C	N	O	0	0
			32	1	23	3	5		
3	Z	1	Total	B	C	N	O	0	0
			32	1	23	3	5		
3	2	1	Total	B	C	N	O	0	0
			32	1	23	3	5		

- Molecule 4 is water.

Mol	Chain	Residues	Atoms		ZeroOcc	AltConf
4	A	10	Total	O	0	0
			10	10		
4	H	16	Total	O	0	0
			16	16		
4	B	10	Total	O	0	0
			10	10		
4	C	20	Total	O	0	0
			20	20		
4	D	4	Total	O	0	0
			4	4		
4	E	10	Total	O	0	0
			10	10		
4	F	7	Total	O	0	0
			7	7		
4	G	16	Total	O	0	0
			16	16		
4	I	11	Total	O	0	0
			11	11		
4	J	13	Total	O	0	0
			13	13		
4	K	9	Total	O	0	0
			9	9		
4	L	14	Total	O	0	0
			14	14		

Continued on next page...

Continued from previous page...

Mol	Chain	Residues	Atoms	ZeroOcc	AltConf
4	M	13	Total O 13 13	0	0
4	N	12	Total O 12 12	0	0
4	O	15	Total O 15 15	0	0
4	P	15	Total O 15 15	0	0
4	Q	6	Total O 6 6	0	0
4	R	12	Total O 12 12	0	0
4	S	5	Total O 5 5	0	0
4	T	8	Total O 8 8	0	0
4	U	2	Total O 2 2	0	0
4	V	20	Total O 20 20	0	0
4	W	7	Total O 7 7	0	0
4	X	20	Total O 20 20	0	0
4	Y	11	Total O 11 11	0	0
4	Z	8	Total O 8 8	0	0
4	1	6	Total O 6 6	0	0
4	2	21	Total O 21 21	0	0

3 Residue-property plots [i](#)

These plots are drawn for all protein, RNA, DNA and oligosaccharide chains in the entry. The first graphic for a chain summarises the proportions of the various outlier classes displayed in the second graphic. The second graphic shows the sequence view annotated by issues in geometry and electron density. Residues are color-coded according to the number of geometric quality criteria for which they contain at least one outlier: green = 0, yellow = 1, orange = 2 and red = 3 or more. A red dot above a residue indicates a poor fit to the electron density ($RSRZ > 2$). Stretches of 2 or more consecutive residues without any outlier are shown as a green connector. Residues present in the sample, but not in the model, are shown in grey.

- Molecule 1: 20S proteasome, alpha and beta subunits

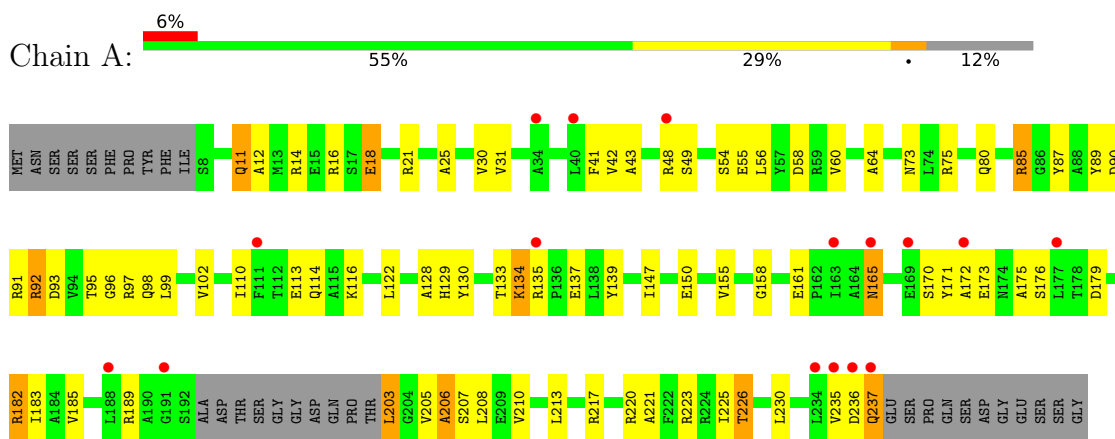

- Molecule 1: 20S proteasome, alpha and beta subunits

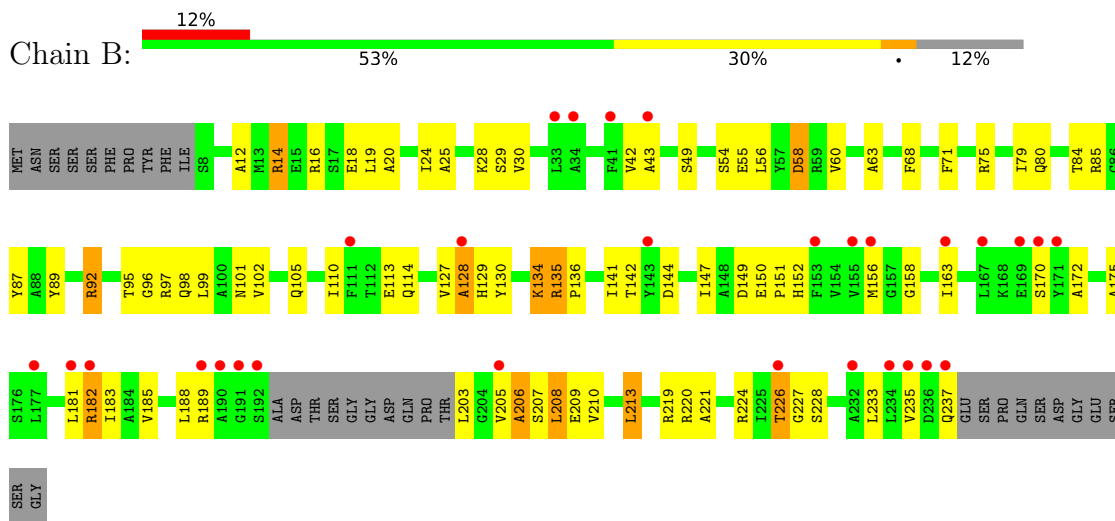

- Molecule 1: 20S proteasome, alpha and beta subunits

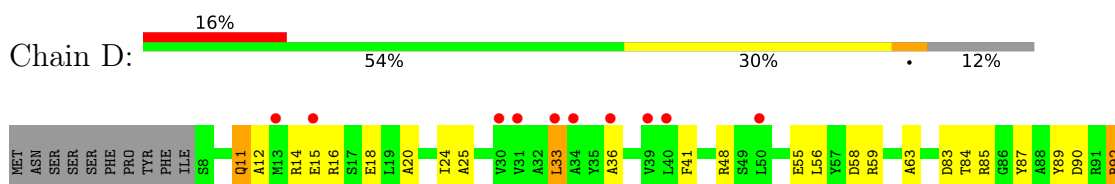

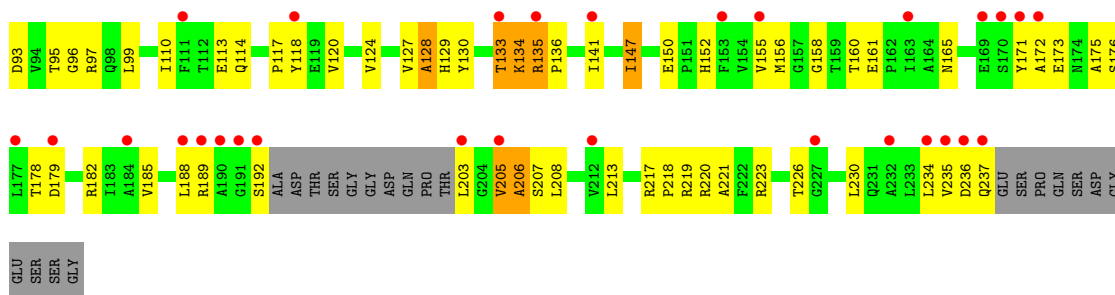

- Molecule 1: 20S proteasome, alpha and beta subunits

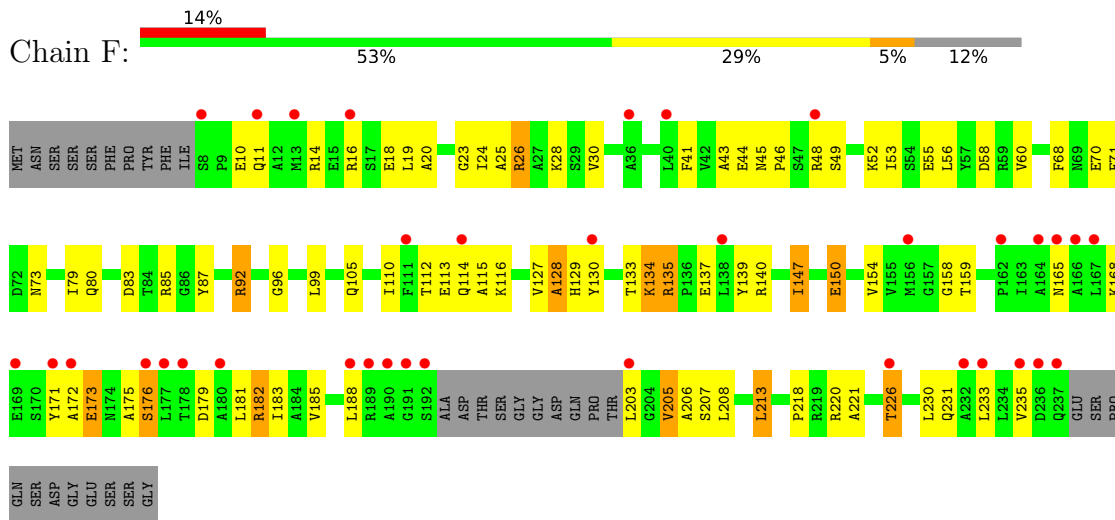

- Molecule 1: 20S proteasome, alpha and beta subunits

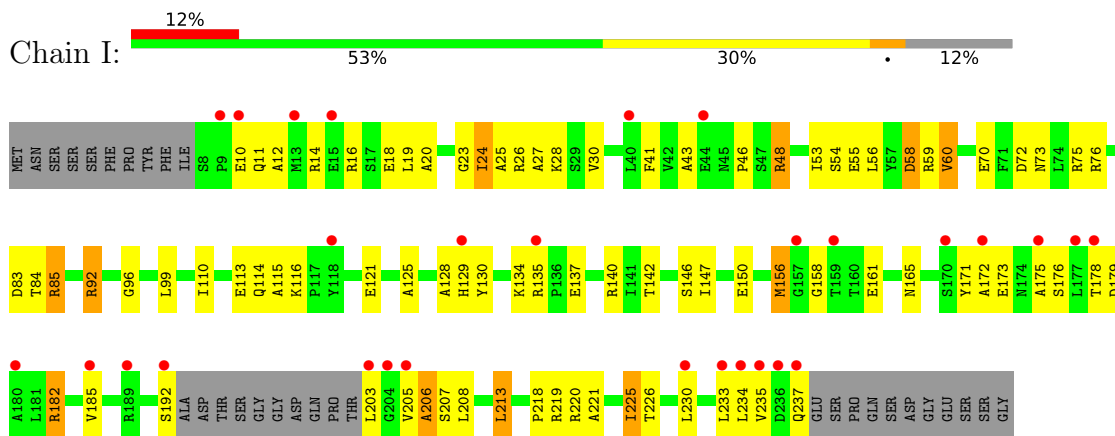

- Molecule 1: 20S proteasome, alpha and beta subunits

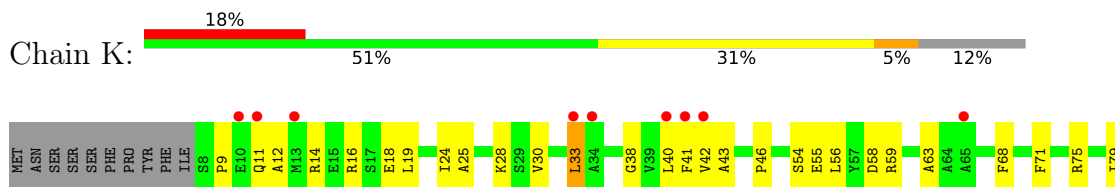

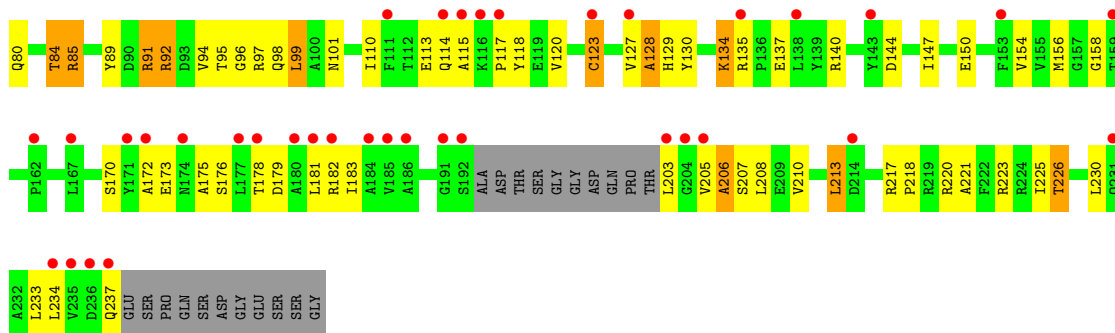

• Molecule 1: 20S proteasome, alpha and beta subunits

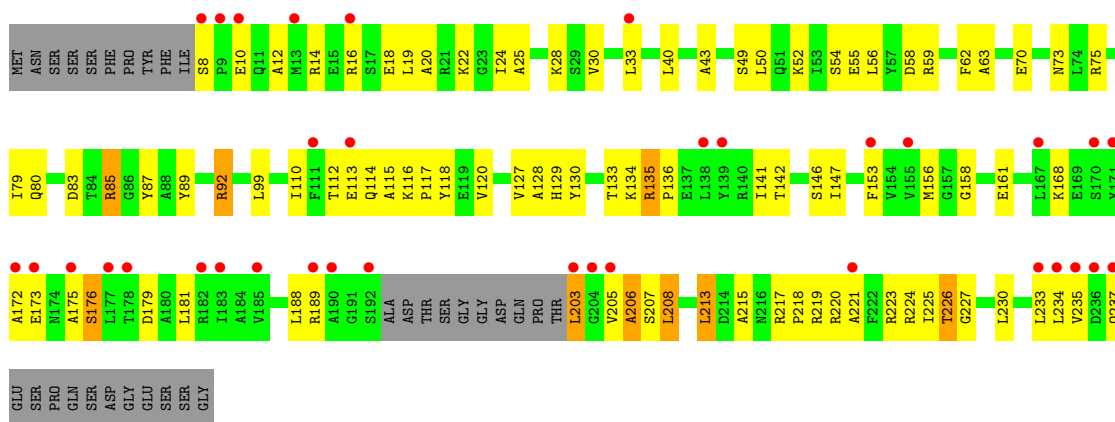

• Molecule 1: 20S proteasome, alpha and beta subunits

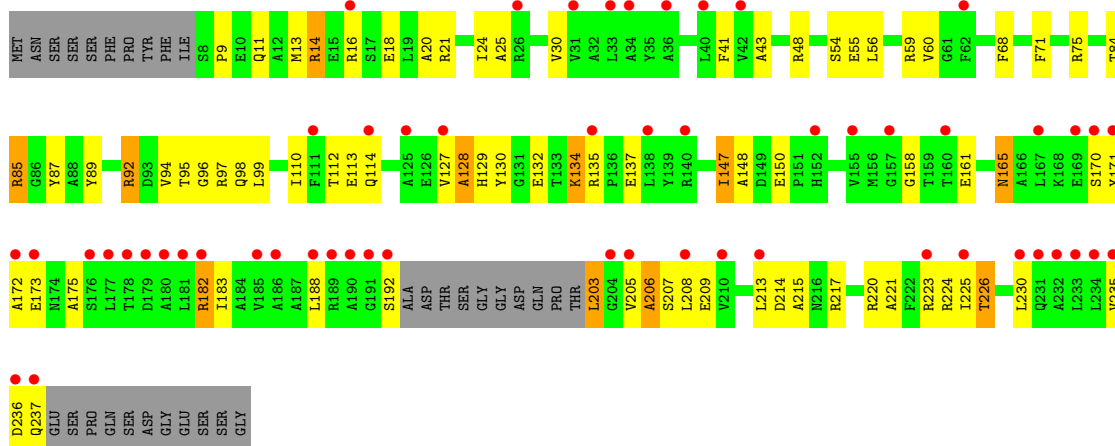

• Molecule 1: 20S proteasome, alpha and beta subunits



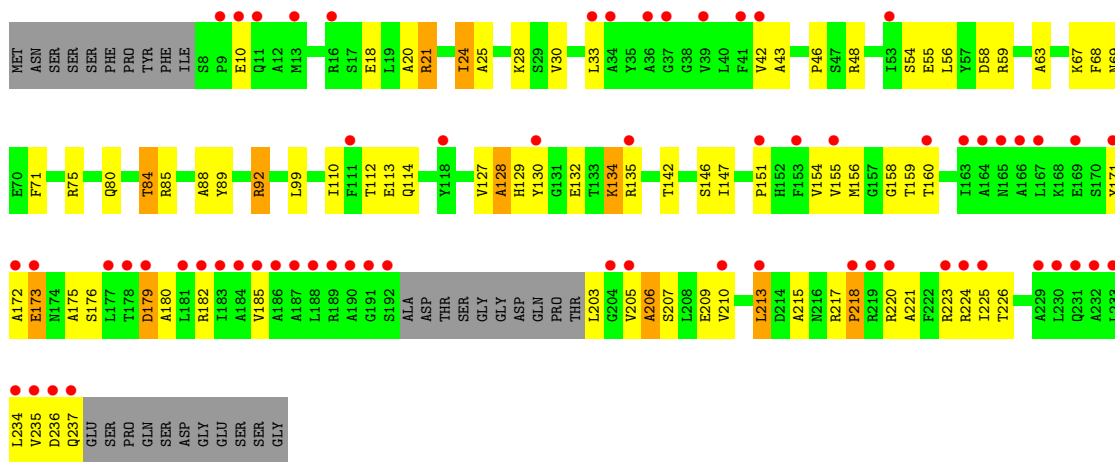

• Molecule 1: 20S proteasome, alpha and beta subunits

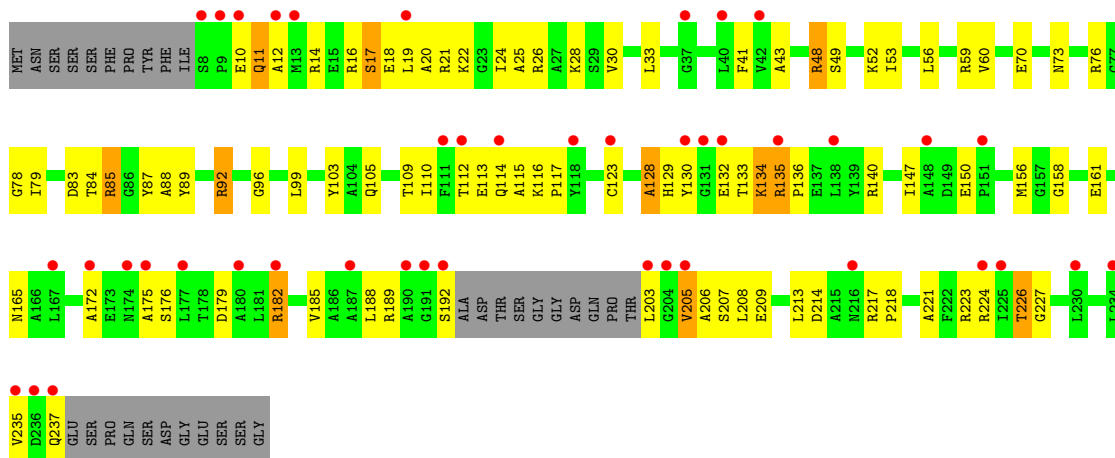

• Molecule 1: 20S proteasome, alpha and beta subunits

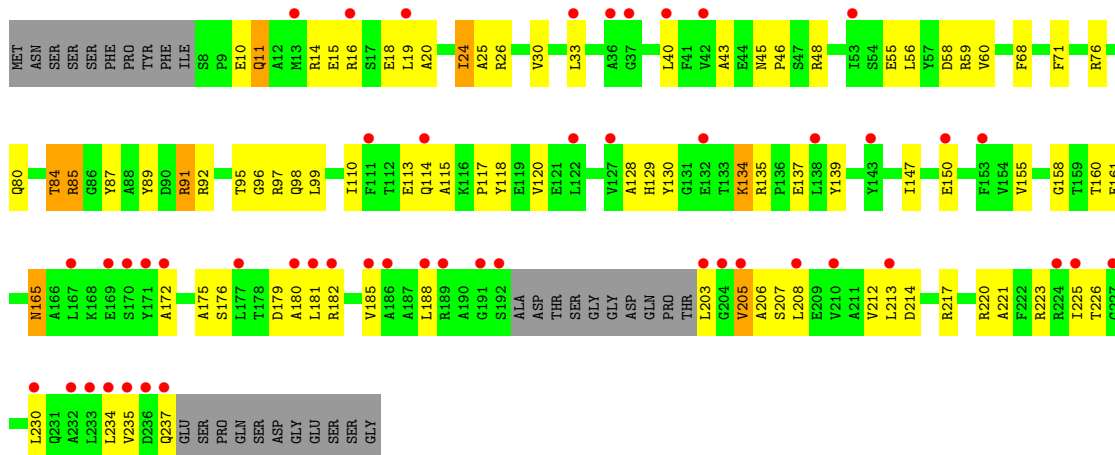

• Molecule 1: 20S proteasome, alpha and beta subunits

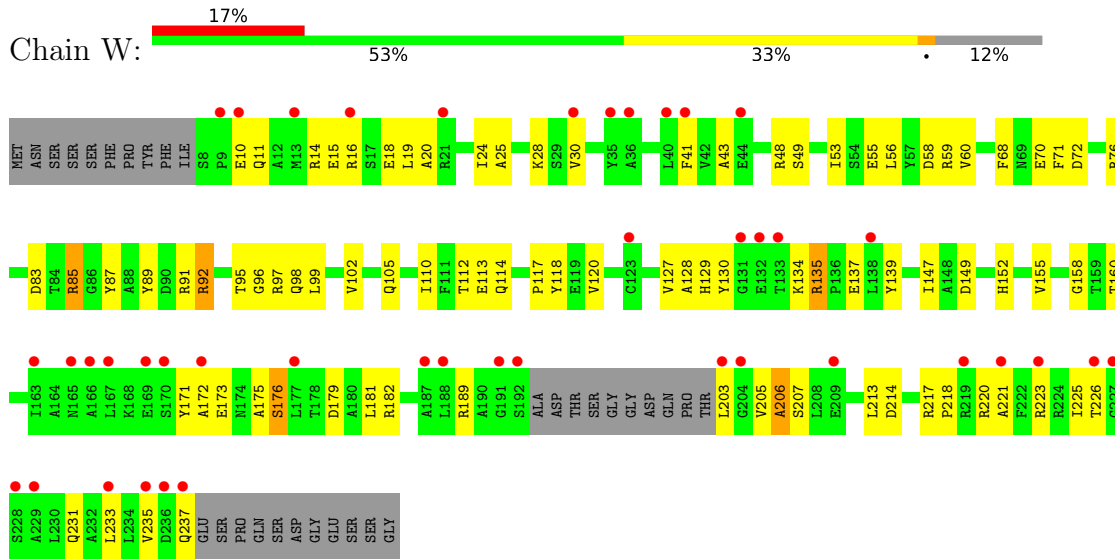

• Molecule 1: 20S proteasome, alpha and beta subunits

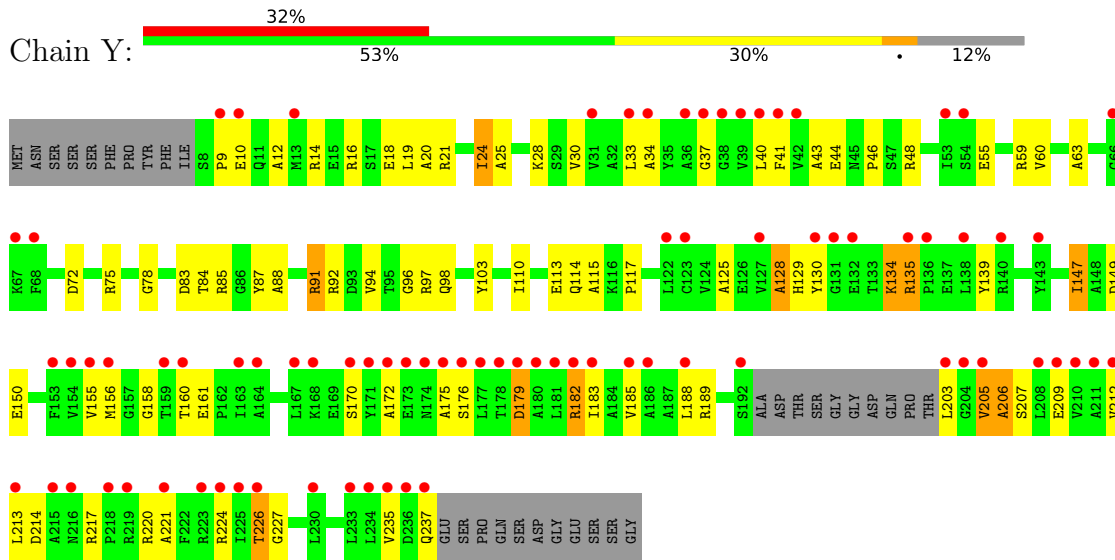

• Molecule 1: 20S proteasome, alpha and beta subunits

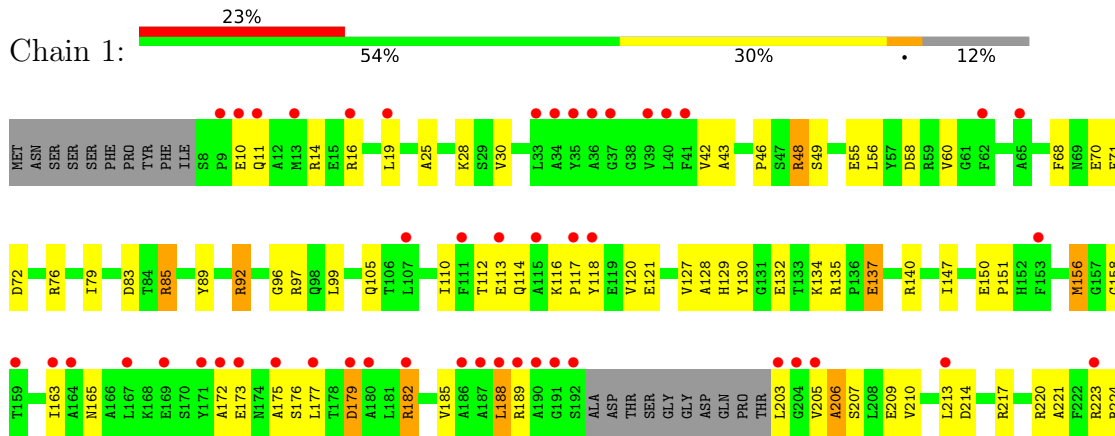



• Molecule 2: proteasome, beta subunit

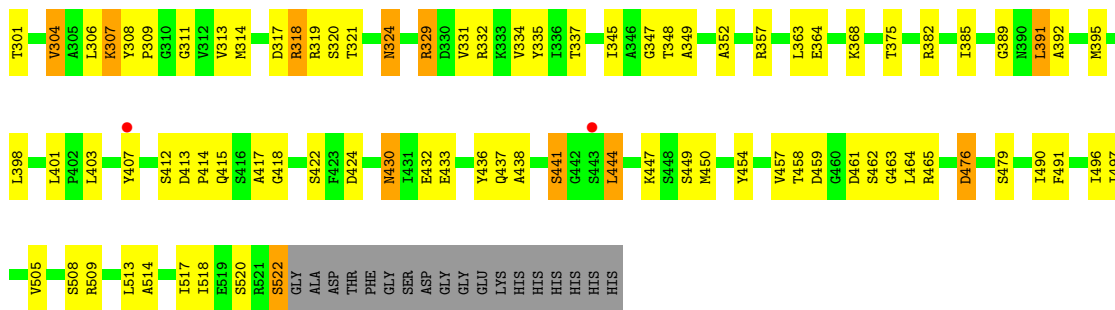

• Molecule 2: proteasome, beta subunit

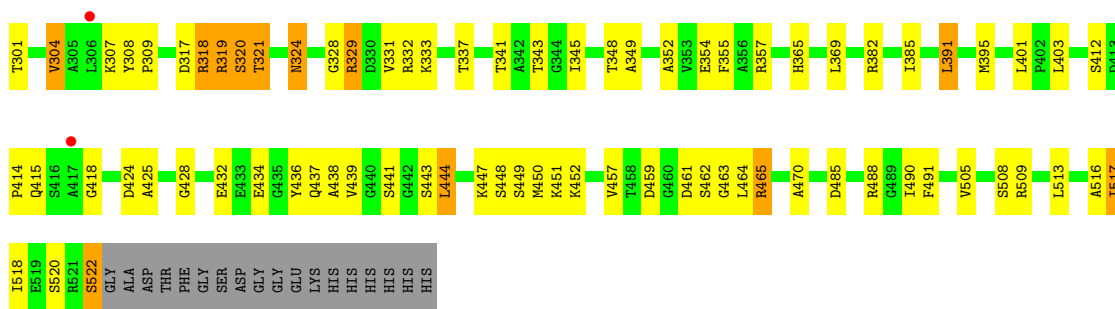

• Molecule 2: proteasome, beta subunit

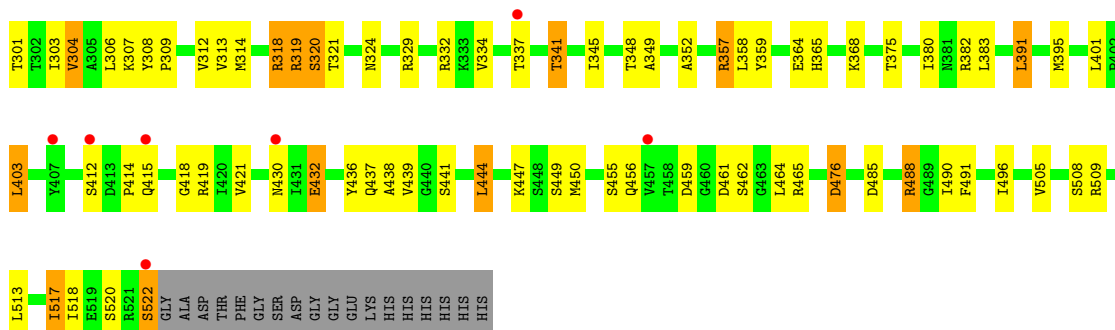

• Molecule 2: proteasome, beta subunit



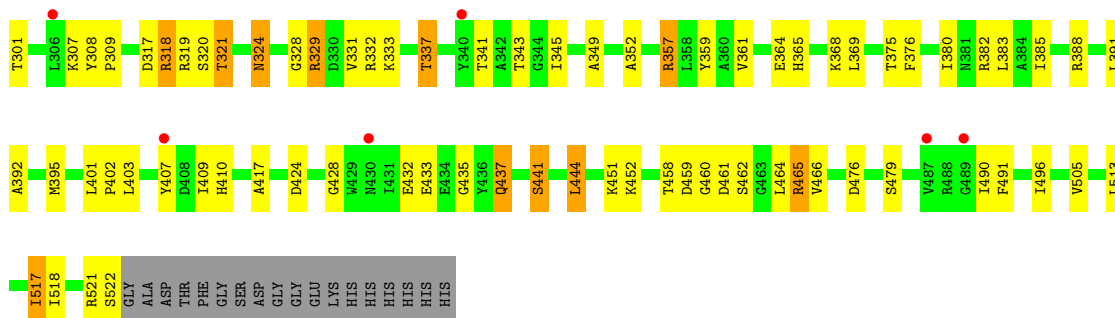

• Molecule 2: proteasome, beta subunit

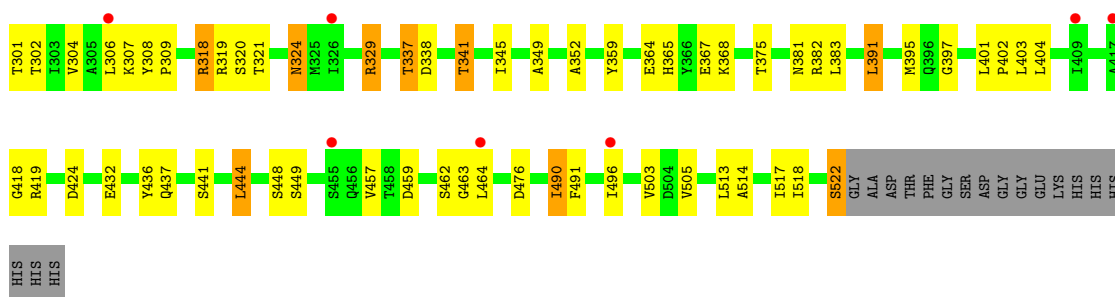

• Molecule 2: proteasome, beta subunit

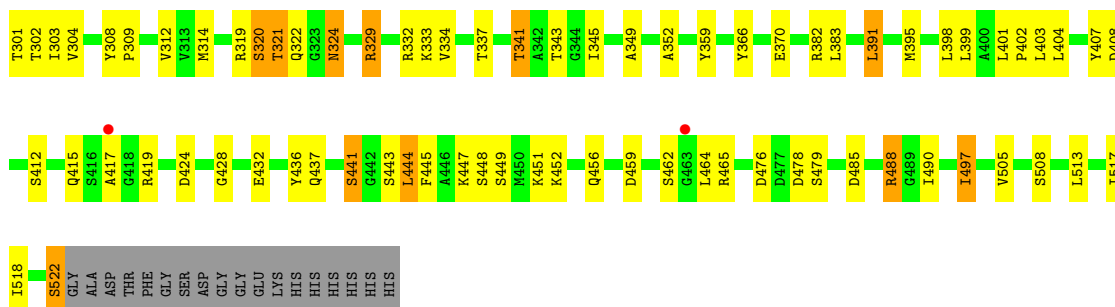

• Molecule 2: proteasome, beta subunit

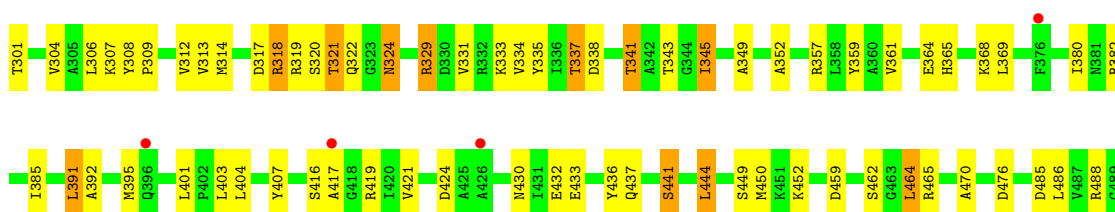

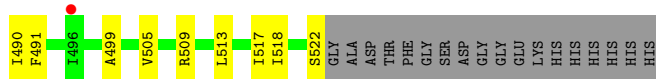

• Molecule 2: proteasome, beta subunit

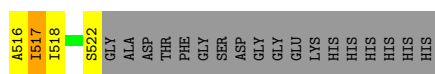
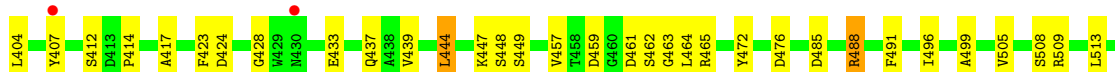

• Molecule 2: proteasome, beta subunit

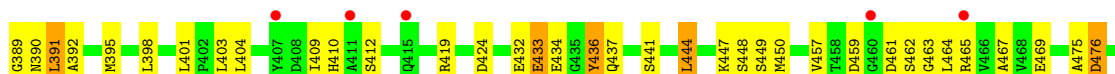
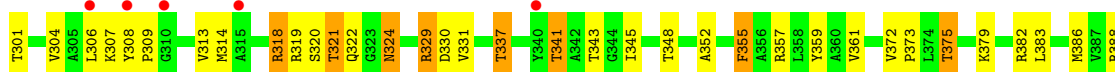

• Molecule 2: proteasome, beta subunit

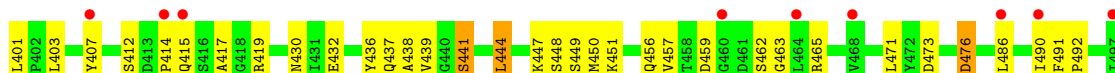
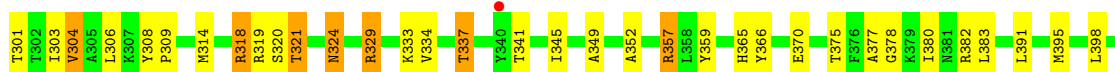

• Molecule 2: proteasome, beta subunit



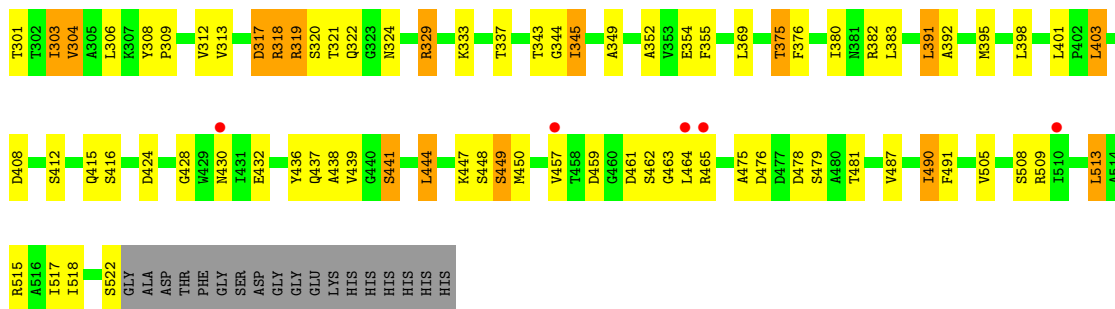

• Molecule 2: proteasome, beta subunit

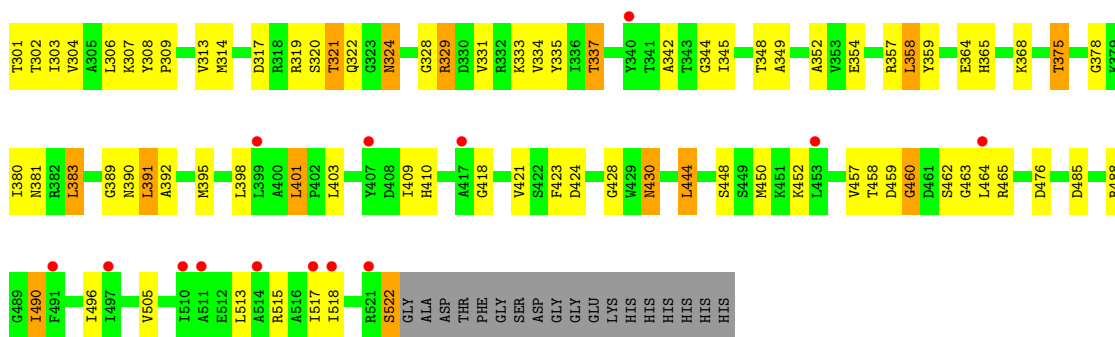

• Molecule 2: proteasome, beta subunit

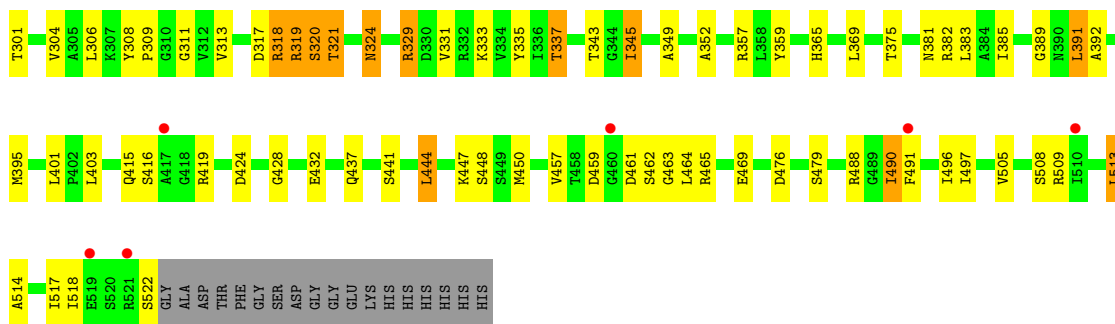

• Molecule 2: proteasome, beta subunit

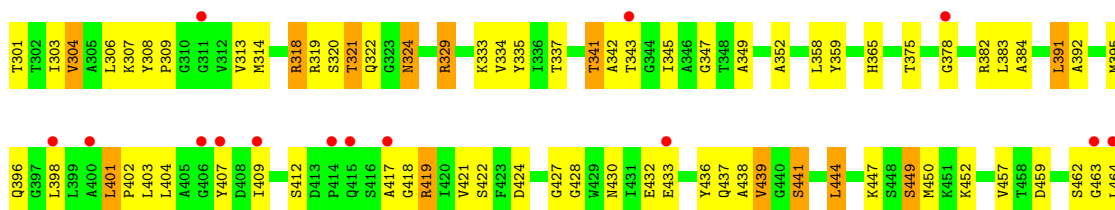



4 Data and refinement statistics

Property	Value	Source
Space group	P 1 21 1	Depositor
Cell constants a, b, c, α , β , γ	173.96Å 116.17Å 200.20Å 90.00° 112.71° 90.00°	Depositor
Resolution (Å)	50.00 – 2.99 49.77 – 2.99	Depositor EDS
% Data completeness (in resolution range)	94.1 (50.00-2.99) 94.1 (49.77-2.99)	Depositor EDS
R_{merge}	0.06	Depositor
R_{sym}	(Not available)	Depositor
$\langle I/\sigma(I) \rangle$ ¹	2.17 (at 3.01Å)	Xtrriage
Refinement program	REFMAC 5.2.0005	Depositor
R, R_{free}	0.226 , 0.262 0.227 , 0.229	Depositor DCC
R_{free} test set	4257 reflections (3.04%)	wwPDB-VP
Wilson B-factor (Å ²)	70.7	Xtrriage
Anisotropy	0.179	Xtrriage
Bulk solvent k_{sol} (e/Å ³), B_{sol} (Å ²)	0.32 , 88.1	EDS
L-test for twinning ²	$\langle L \rangle = 0.48$, $\langle L^2 \rangle = 0.30$	Xtrriage
Estimated twinning fraction	No twinning to report.	Xtrriage
F_o, F_c correlation	0.92	EDS
Total number of atoms	47389	wwPDB-VP
Average B, all atoms (Å ²)	85.0	wwPDB-VP

Xtrriage's analysis on translational NCS is as follows: *The largest off-origin peak in the Patterson function is 2.18% of the height of the origin peak. No significant pseudotranslation is detected.*

¹Intensities estimated from amplitudes.

²Theoretical values of $\langle |L| \rangle$, $\langle L^2 \rangle$ for acentric reflections are 0.5, 0.333 respectively for untwinned datasets, and 0.375, 0.2 for perfectly twinned datasets.

5 Model quality [i](#)

5.1 Standard geometry [i](#)

Bond lengths and bond angles in the following residue types are not validated in this section: M1N

The Z score for a bond length (or angle) is the number of standard deviations the observed value is removed from the expected value. A bond length (or angle) with $|Z| > 5$ is considered an outlier worth inspection. RMSZ is the root-mean-square of all Z scores of the bond lengths (or angles).

Mol	Chain	Bond lengths		Bond angles	
		RMSZ	# Z >5	RMSZ	# Z >5
1	1	0.49	0/1717	0.62	0/2320
1	A	0.45	0/1717	0.61	0/2320
1	B	0.45	0/1717	0.64	0/2320
1	D	0.48	0/1717	0.63	1/2320 (0.0%)
1	F	0.45	0/1717	0.63	0/2320
1	I	0.46	0/1717	0.61	0/2320
1	K	0.46	0/1717	0.63	0/2320
1	M	0.45	0/1717	0.63	0/2320
1	O	0.47	0/1717	0.62	0/2320
1	Q	0.49	0/1717	0.61	0/2320
1	S	0.47	0/1717	0.61	0/2320
1	U	0.47	0/1717	0.63	0/2320
1	W	0.62	2/1717 (0.1%)	0.64	1/2320 (0.0%)
1	Y	0.45	0/1717	0.61	0/2320
2	2	0.55	0/1662	0.71	0/2254
2	C	0.53	0/1662	0.72	0/2254
2	E	0.51	0/1662	0.72	0/2254
2	G	0.51	0/1662	0.69	0/2254
2	H	0.55	0/1662	0.71	0/2254
2	J	0.51	0/1662	0.69	0/2254
2	L	0.53	0/1662	0.70	0/2254
2	N	0.52	0/1662	0.69	0/2254
2	P	0.53	0/1662	0.73	0/2254
2	R	0.60	1/1662 (0.1%)	0.71	0/2254
2	T	0.54	1/1662 (0.1%)	0.68	0/2254
2	V	0.50	0/1662	0.69	0/2254
2	X	0.50	0/1662	0.69	0/2254
2	Z	0.52	0/1662	0.71	0/2254
All	All	0.50	4/47306 (0.0%)	0.66	2/64036 (0.0%)

All (4) bond length outliers are listed below:

Mol	Chain	Res	Type	Atoms	Z	Observed(Å)	Ideal(Å)
1	W	173	GLU	CD-OE1	13.22	1.40	1.25
2	R	412	SER	CB-OG	12.49	1.58	1.42
1	W	173	GLU	CD-OE2	11.28	1.38	1.25
2	T	456	GLN	CD-NE2	5.50	1.46	1.32

All (2) bond angle outliers are listed below:

Mol	Chain	Res	Type	Atoms	Z	Observed(°)	Ideal(°)
1	D	33	LEU	CA-CB-CG	5.71	128.44	115.30
1	W	173	GLU	OE1-CD-OE2	5.57	129.98	123.30

There are no chirality outliers.

There are no planarity outliers.

5.2 Too-close contacts [i](#)

In the following table, the Non-H and H(model) columns list the number of non-hydrogen atoms and hydrogen atoms in the chain respectively. The H(added) column lists the number of hydrogen atoms added and optimized by MolProbity. The Clashes column lists the number of clashes within the asymmetric unit, whereas Symm-Clashes lists symmetry-related clashes.

Mol	Chain	Non-H	H(model)	H(added)	Clashes	Symm-Clashes
1	1	1692	0	1688	68	0
1	A	1692	0	1688	53	1
1	B	1692	0	1688	55	0
1	D	1692	0	1688	54	1
1	F	1692	0	1688	64	0
1	I	1692	0	1688	53	0
1	K	1692	0	1688	64	0
1	M	1692	0	1688	68	0
1	O	1692	0	1688	59	0
1	Q	1692	0	1688	45	0
1	S	1692	0	1688	65	0
1	U	1692	0	1688	53	0
1	W	1692	0	1688	60	0
1	Y	1692	0	1688	54	0
2	2	1638	0	1629	76	0
2	C	1638	0	1629	68	0
2	E	1638	0	1629	55	0
2	G	1638	0	1629	68	0
2	H	1638	0	1629	64	0
2	J	1638	0	1629	55	0

Continued on next page...

Continued from previous page...

Mol	Chain	Non-H	H(model)	H(added)	Clashes	Symm-Clashes
2	L	1638	0	1629	67	0
2	N	1638	0	1629	80	0
2	P	1638	0	1629	56	0
2	R	1638	0	1629	55	0
2	T	1638	0	1629	55	0
2	V	1638	0	1629	65	0
2	X	1638	0	1629	73	0
2	Z	1638	0	1629	60	0
3	2	32	0	32	9	0
3	C	32	0	32	12	0
3	E	32	0	32	14	0
3	G	32	0	32	10	0
3	H	32	0	32	12	0
3	J	32	0	32	17	0
3	L	32	0	32	16	0
3	N	32	0	32	16	0
3	P	32	0	32	14	0
3	R	32	0	32	9	0
3	T	32	0	32	11	0
3	V	32	0	32	17	0
3	X	32	0	32	14	0
3	Z	32	0	32	17	0
4	1	6	0	0	4	0
4	2	21	0	0	4	0
4	A	10	0	0	0	0
4	B	10	0	0	2	0
4	C	20	0	0	6	0
4	D	4	0	0	2	0
4	E	10	0	0	1	0
4	F	7	0	0	4	0
4	G	16	0	0	2	0
4	H	16	0	0	4	0
4	I	11	0	0	2	0
4	J	13	0	0	1	0
4	K	9	0	0	0	0
4	L	14	0	0	2	0
4	M	13	0	0	5	0
4	N	12	0	0	3	0
4	O	15	0	0	1	0
4	P	15	0	0	5	0
4	Q	6	0	0	3	0
4	R	12	0	0	4	0

Continued on next page...

Continued from previous page...

Mol	Chain	Non-H	H(model)	H(added)	Clashes	Symm-Clashes
4	S	5	0	0	0	0
4	T	8	0	0	2	0
4	U	2	0	0	0	0
4	V	20	0	0	5	0
4	W	7	0	0	2	0
4	X	20	0	0	14	0
4	Y	11	0	0	5	0
4	Z	8	0	0	0	0
All	All	47389	0	46886	1629	1

The all-atom clashscore is defined as the number of clashes found per 1000 atoms (including hydrogen atoms). The all-atom clashscore for this structure is 17.

The worst 5 of 1629 close contacts within the same asymmetric unit are listed below, sorted by their clash magnitude.

Atom-1	Atom-2	Interatomic distance (Å)	Clash overlap (Å)
2:C:424:ASP:HA	4:C:542:HOH:O	1.37	1.22
2:X:303:ILE:HG13	4:X:58:HOH:O	1.35	1.22
2:J:444:LEU:HD12	2:Z:444:LEU:HD12	1.31	1.08
2:L:444:LEU:HD12	2:P:444:LEU:HD12	1.35	1.07
3:N:273:M1N:H221	3:N:273:M1N:O16	1.55	1.06

All (1) symmetry-related close contacts are listed below. The label for Atom-2 includes the symmetry operator and encoded unit-cell translations to be applied.

Atom-1	Atom-2	Interatomic distance (Å)	Clash overlap (Å)
1:A:236:ASP:O	1:D:133:THR:OG1[2_655]	2.12	0.08

5.3 Torsion angles [i](#)

5.3.1 Protein backbone [i](#)

In the following table, the Percentiles column shows the percent Ramachandran outliers of the chain as a percentile score with respect to all X-ray entries followed by that with respect to entries of similar resolution.

The Analysed column shows the number of residues for which the backbone conformation was analysed, and the total number of residues.

Mol	Chain	Analysed	Favoured	Allowed	Outliers	Percentiles	
1	1	216/251 (86%)	188 (87%)	23 (11%)	5 (2%)	6	30
1	A	216/251 (86%)	190 (88%)	21 (10%)	5 (2%)	6	30
1	B	216/251 (86%)	189 (88%)	22 (10%)	5 (2%)	6	30
1	D	216/251 (86%)	188 (87%)	22 (10%)	6 (3%)	5	25
1	F	216/251 (86%)	192 (89%)	18 (8%)	6 (3%)	5	25
1	I	216/251 (86%)	188 (87%)	22 (10%)	6 (3%)	5	25
1	K	216/251 (86%)	190 (88%)	20 (9%)	6 (3%)	5	25
1	M	216/251 (86%)	190 (88%)	21 (10%)	5 (2%)	6	30
1	O	216/251 (86%)	189 (88%)	22 (10%)	5 (2%)	6	30
1	Q	216/251 (86%)	189 (88%)	20 (9%)	7 (3%)	4	22
1	S	216/251 (86%)	188 (87%)	22 (10%)	6 (3%)	5	25
1	U	216/251 (86%)	188 (87%)	23 (11%)	5 (2%)	6	30
1	W	216/251 (86%)	187 (87%)	23 (11%)	6 (3%)	5	25
1	Y	216/251 (86%)	188 (87%)	24 (11%)	4 (2%)	8	36
2	2	220/240 (92%)	202 (92%)	18 (8%)	0	100	100
2	C	220/240 (92%)	201 (91%)	19 (9%)	0	100	100
2	E	220/240 (92%)	201 (91%)	19 (9%)	0	100	100
2	G	220/240 (92%)	201 (91%)	18 (8%)	1 (0%)	29	68
2	H	220/240 (92%)	201 (91%)	17 (8%)	2 (1%)	17	55
2	J	220/240 (92%)	199 (90%)	21 (10%)	0	100	100
2	L	220/240 (92%)	199 (90%)	21 (10%)	0	100	100
2	N	220/240 (92%)	200 (91%)	19 (9%)	1 (0%)	29	68
2	P	220/240 (92%)	202 (92%)	17 (8%)	1 (0%)	29	68
2	R	220/240 (92%)	204 (93%)	13 (6%)	3 (1%)	11	43
2	T	220/240 (92%)	202 (92%)	18 (8%)	0	100	100
2	V	220/240 (92%)	202 (92%)	16 (7%)	2 (1%)	17	55
2	X	220/240 (92%)	200 (91%)	18 (8%)	2 (1%)	17	55
2	Z	220/240 (92%)	199 (90%)	20 (9%)	1 (0%)	29	68
All	All	6104/6874 (89%)	5457 (89%)	557 (9%)	90 (2%)	10	42

5 of 90 Ramachandran outliers are listed below:

Mol	Chain	Res	Type
1	A	128	ALA
1	B	128	ALA
1	D	128	ALA
1	F	128	ALA
1	I	128	ALA

5.3.2 Protein sidechains [i](#)

In the following table, the Percentiles column shows the percent sidechain outliers of the chain as a percentile score with respect to all X-ray entries followed by that with respect to entries of similar resolution.

The Analysed column shows the number of residues for which the sidechain conformation was analysed, and the total number of residues.

Mol	Chain	Analysed	Rotameric	Outliers	Percentiles	
1	1	169/195 (87%)	152 (90%)	17 (10%)	7	29
1	A	169/195 (87%)	151 (89%)	18 (11%)	6	26
1	B	169/195 (87%)	149 (88%)	20 (12%)	5	22
1	D	169/195 (87%)	148 (88%)	21 (12%)	4	20
1	F	169/195 (87%)	149 (88%)	20 (12%)	5	22
1	I	169/195 (87%)	147 (87%)	22 (13%)	4	19
1	K	169/195 (87%)	148 (88%)	21 (12%)	4	20
1	M	169/195 (87%)	151 (89%)	18 (11%)	6	26
1	O	169/195 (87%)	148 (88%)	21 (12%)	4	20
1	Q	169/195 (87%)	150 (89%)	19 (11%)	6	24
1	S	169/195 (87%)	147 (87%)	22 (13%)	4	19
1	U	169/195 (87%)	150 (89%)	19 (11%)	6	24
1	W	169/195 (87%)	154 (91%)	15 (9%)	9	35
1	Y	169/195 (87%)	147 (87%)	22 (13%)	4	19
2	2	165/178 (93%)	138 (84%)	27 (16%)	2	11
2	C	165/178 (93%)	140 (85%)	25 (15%)	3	14
2	E	165/178 (93%)	136 (82%)	29 (18%)	2	10
2	G	165/178 (93%)	145 (88%)	20 (12%)	5	21
2	H	165/178 (93%)	140 (85%)	25 (15%)	3	14
2	J	165/178 (93%)	144 (87%)	21 (13%)	4	19

Continued on next page...

Continued from previous page...

Mol	Chain	Analysed	Rotameric	Outliers	Percentiles	
2	L	165/178 (93%)	141 (86%)	24 (14%)	3	15
2	N	165/178 (93%)	143 (87%)	22 (13%)	4	17
2	P	165/178 (93%)	142 (86%)	23 (14%)	3	16
2	R	165/178 (93%)	135 (82%)	30 (18%)	1	9
2	T	165/178 (93%)	139 (84%)	26 (16%)	2	12
2	V	165/178 (93%)	137 (83%)	28 (17%)	2	10
2	X	165/178 (93%)	146 (88%)	19 (12%)	5	24
2	Z	165/178 (93%)	143 (87%)	22 (13%)	4	17
All	All	4676/5222 (90%)	4060 (87%)	616 (13%)	4	18

5 of 616 residues with a non-rotameric sidechain are listed below:

Mol	Chain	Res	Type
1	U	205	VAL
1	1	49	SER
2	V	375	THR
1	U	203	LEU
2	X	403	LEU

Sometimes sidechains can be flipped to improve hydrogen bonding and reduce clashes. 5 of 138 such sidechains are listed below:

Mol	Chain	Res	Type
2	X	322	GLN
2	X	456	GLN
1	1	105	GLN
2	J	365	HIS
2	J	324	ASN

5.3.3 RNA [i](#)

There are no RNA molecules in this entry.

5.4 Non-standard residues in protein, DNA, RNA chains [i](#)

There are no non-standard protein/DNA/RNA residues in this entry.

5.5 Carbohydrates [i](#)

There are no monosaccharides in this entry.

5.6 Ligand geometry [i](#)

14 ligands are modelled in this entry.

In the following table, the Counts columns list the number of bonds (or angles) for which Mogul statistics could be retrieved, the number of bonds (or angles) that are observed in the model and the number of bonds (or angles) that are defined in the Chemical Component Dictionary. The Link column lists molecule types, if any, to which the group is linked. The Z score for a bond length (or angle) is the number of standard deviations the observed value is removed from the expected value. A bond length (or angle) with $|Z| > 2$ is considered an outlier worth inspection. RMSZ is the root-mean-square of all Z scores of the bond lengths (or angles).

Mol	Type	Chain	Res	Link	Bond lengths			Bond angles		
					Counts	RMSZ	# Z > 2	Counts	RMSZ	# Z > 2
3	M1N	J	273	2	30,34,34	2.78	13 (43%)	39,46,46	4.17	16 (41%)
3	M1N	L	273	2	30,34,34	2.69	13 (43%)	39,46,46	4.61	16 (41%)
3	M1N	G	273	2	30,34,34	2.94	15 (50%)	39,46,46	4.36	15 (38%)
3	M1N	X	273	2	30,34,34	2.95	16 (53%)	39,46,46	4.45	16 (41%)
3	M1N	2	273	2	30,34,34	2.95	14 (46%)	39,46,46	4.78	18 (46%)
3	M1N	R	273	2	30,34,34	2.95	14 (46%)	39,46,46	4.39	13 (33%)
3	M1N	T	273	2	30,34,34	2.95	15 (50%)	39,46,46	4.39	16 (41%)
3	M1N	H	273	2	30,34,34	2.71	12 (40%)	39,46,46	4.48	16 (41%)
3	M1N	N	273	2	30,34,34	2.76	14 (46%)	39,46,46	4.26	17 (43%)
3	M1N	Z	273	2	30,34,34	2.82	13 (43%)	39,46,46	4.04	15 (38%)
3	M1N	P	273	2	30,34,34	2.82	12 (40%)	39,46,46	4.50	18 (46%)
3	M1N	V	273	2	30,34,34	2.75	15 (50%)	39,46,46	4.22	15 (38%)
3	M1N	E	273	2	30,34,34	2.71	13 (43%)	39,46,46	4.61	18 (46%)
3	M1N	C	273	2	30,34,34	2.60	12 (40%)	39,46,46	4.40	17 (43%)

In the following table, the Chirals column lists the number of chiral outliers, the number of chiral centers analysed, the number of these observed in the model and the number defined in the Chemical Component Dictionary. Similar counts are reported in the Torsion and Rings columns. '-' means no outliers of that kind were identified.

Mol	Type	Chain	Res	Link	Chirals	Torsions	Rings
3	M1N	J	273	2	-	9/22/36/36	0/3/3/3
3	M1N	L	273	2	-	10/22/36/36	0/3/3/3

Continued on next page...

Continued from previous page...

Mol	Type	Chain	Res	Link	Chirals	Torsions	Rings
3	M1N	G	273	2	-	10/22/36/36	0/3/3/3
3	M1N	X	273	2	-	10/22/36/36	0/3/3/3
3	M1N	2	273	2	-	10/22/36/36	0/3/3/3
3	M1N	R	273	2	-	12/22/36/36	0/3/3/3
3	M1N	T	273	2	-	8/22/36/36	0/3/3/3
3	M1N	H	273	2	-	8/22/36/36	0/3/3/3
3	M1N	N	273	2	-	10/22/36/36	0/3/3/3
3	M1N	Z	273	2	-	11/22/36/36	0/3/3/3
3	M1N	P	273	2	-	11/22/36/36	0/3/3/3
3	M1N	V	273	2	-	11/22/36/36	0/3/3/3
3	M1N	E	273	2	-	8/22/36/36	0/3/3/3
3	M1N	C	273	2	-	9/22/36/36	0/3/3/3

The worst 5 of 191 bond length outliers are listed below:

Mol	Chain	Res	Type	Atoms	Z	Observed(Å)	Ideal(Å)
3	E	273	M1N	C5-C4	-6.78	1.37	1.54
3	P	273	M1N	C5-C4	-6.76	1.37	1.54
3	G	273	M1N	C5-C4	-6.66	1.37	1.54
3	J	273	M1N	C5-C4	-6.60	1.37	1.54
3	N	273	M1N	C5-C4	-6.52	1.37	1.54

The worst 5 of 226 bond angle outliers are listed below:

Mol	Chain	Res	Type	Atoms	Z	Observed(°)	Ideal(°)
3	E	273	M1N	C15-C22-C23	19.99	140.51	115.39
3	T	273	M1N	C15-C22-C23	19.39	139.76	115.39
3	2	273	M1N	C15-C22-C23	19.25	139.58	115.39
3	L	273	M1N	C15-C22-C23	18.81	139.02	115.39
3	G	273	M1N	C15-C22-C23	18.46	138.59	115.39

There are no chirality outliers.

5 of 137 torsion outliers are listed below:

Mol	Chain	Res	Type	Atoms
3	H	273	M1N	O3-C2-N1-C15
3	H	273	M1N	C4-C2-N1-C15
3	H	273	M1N	C2-C4-C5-C31
3	H	273	M1N	N6-C4-C5-C31

Continued on next page...

Continued from previous page...

Mol	Chain	Res	Type	Atoms
3	H	273	M1N	N9-C7-N6-C4

There are no ring outliers.

14 monomers are involved in 188 short contacts:

Mol	Chain	Res	Type	Clashes	Symm-Clashes
3	J	273	M1N	17	0
3	L	273	M1N	16	0
3	G	273	M1N	10	0
3	X	273	M1N	14	0
3	2	273	M1N	9	0
3	R	273	M1N	9	0
3	T	273	M1N	11	0
3	H	273	M1N	12	0
3	N	273	M1N	16	0
3	Z	273	M1N	17	0
3	P	273	M1N	14	0
3	V	273	M1N	17	0
3	E	273	M1N	14	0
3	C	273	M1N	12	0

The following is a two-dimensional graphical depiction of Mogul quality analysis of bond lengths, bond angles, torsion angles, and ring geometry for all instances of the Ligand of Interest. In addition, ligands with molecular weight > 250 and outliers as shown on the validation Tables will also be included. For torsion angles, if less than 5% of the Mogul distribution of torsion angles is within 10 degrees of the torsion angle in question, then that torsion angle is considered an outlier. Any bond that is central to one or more torsion angles identified as an outlier by Mogul will be highlighted in the graph. For rings, the root-mean-square deviation (RMSD) between the ring in question and similar rings identified by Mogul is calculated over all ring torsion angles. If the average RMSD is greater than 60 degrees and the minimal RMSD between the ring in question and any Mogul-identified rings is also greater than 60 degrees, then that ring is considered an outlier. The outliers are highlighted in purple. The color gray indicates Mogul did not find sufficient equivalents in the CSD to analyse the geometry.

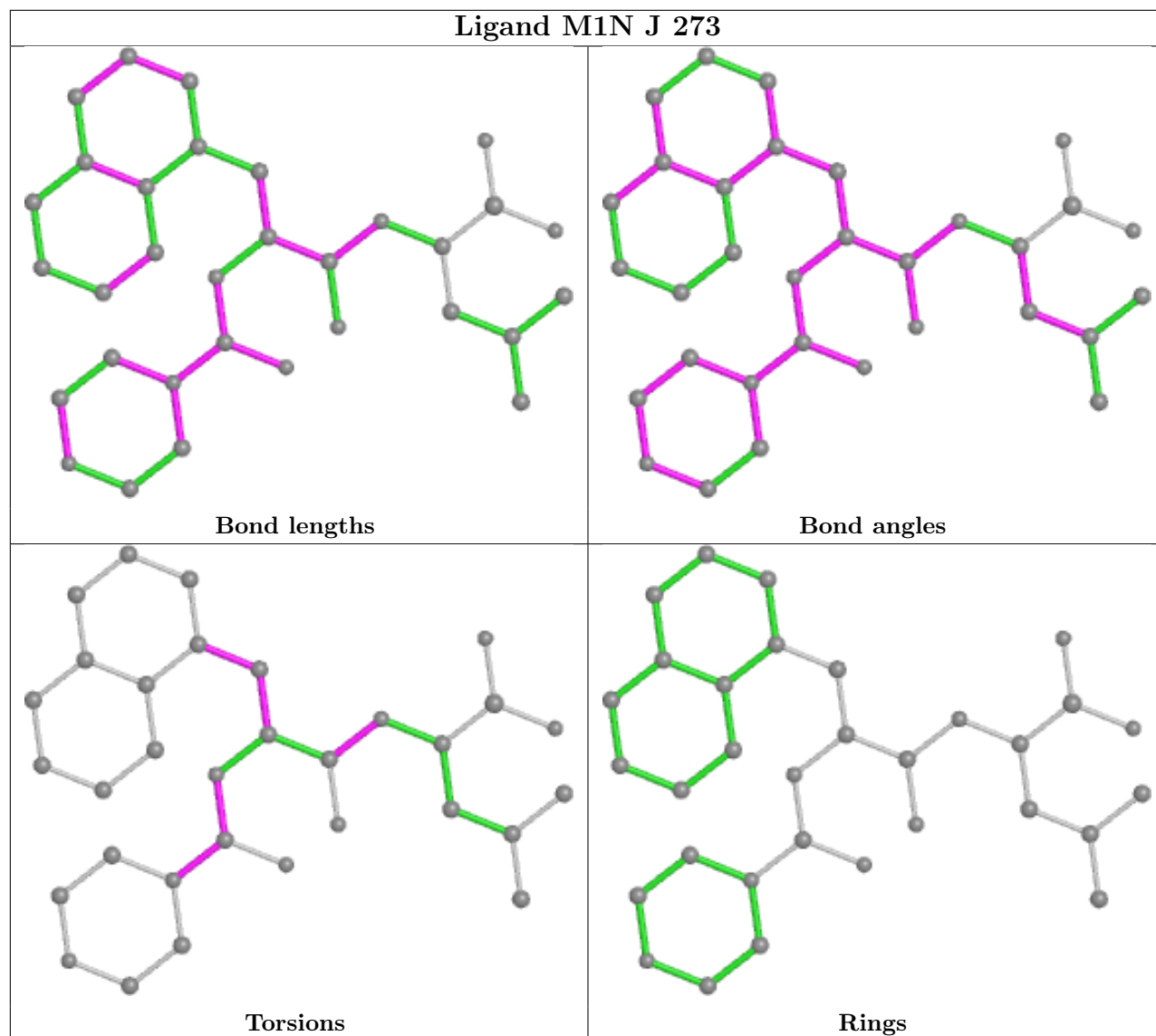

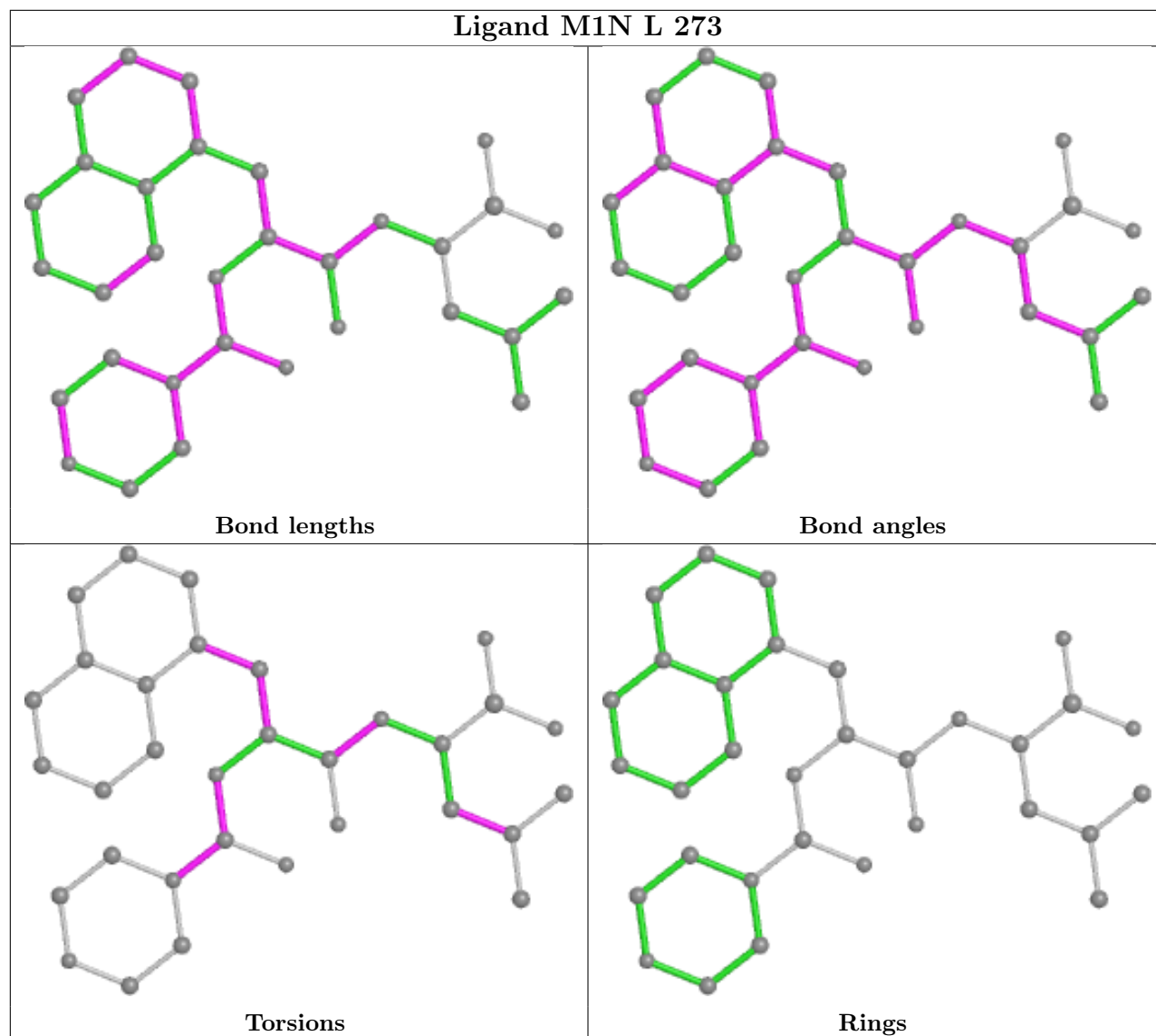

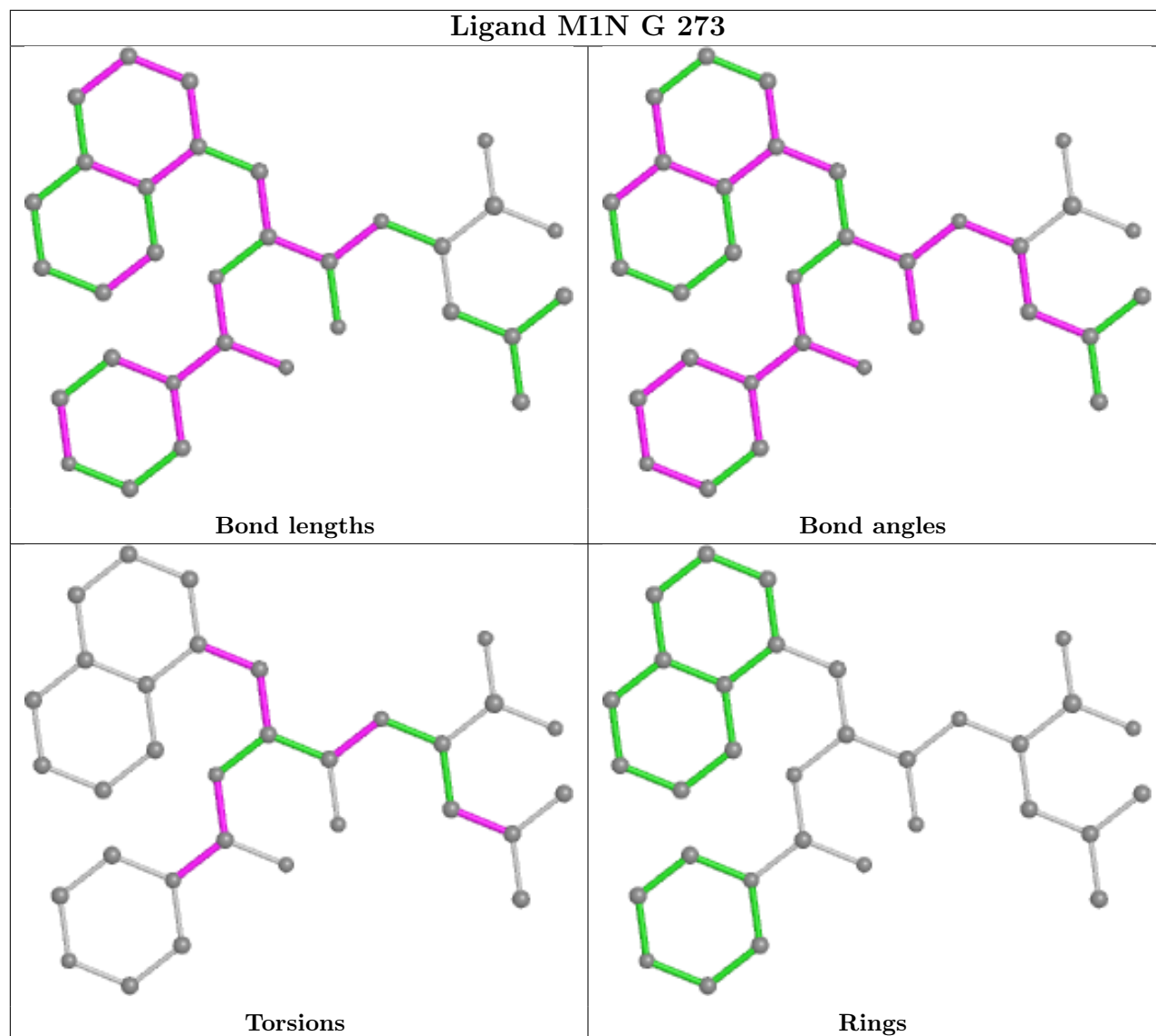

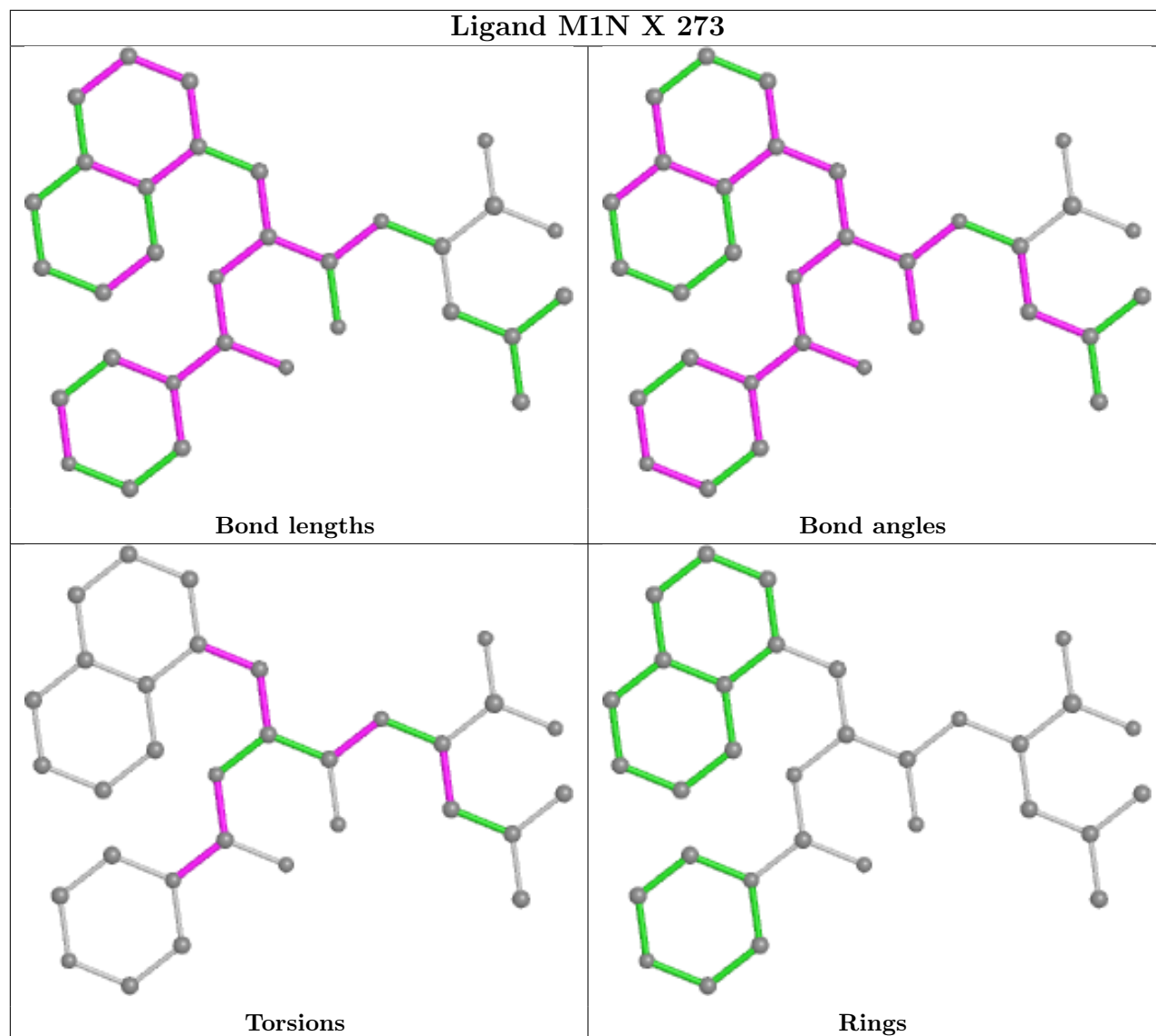

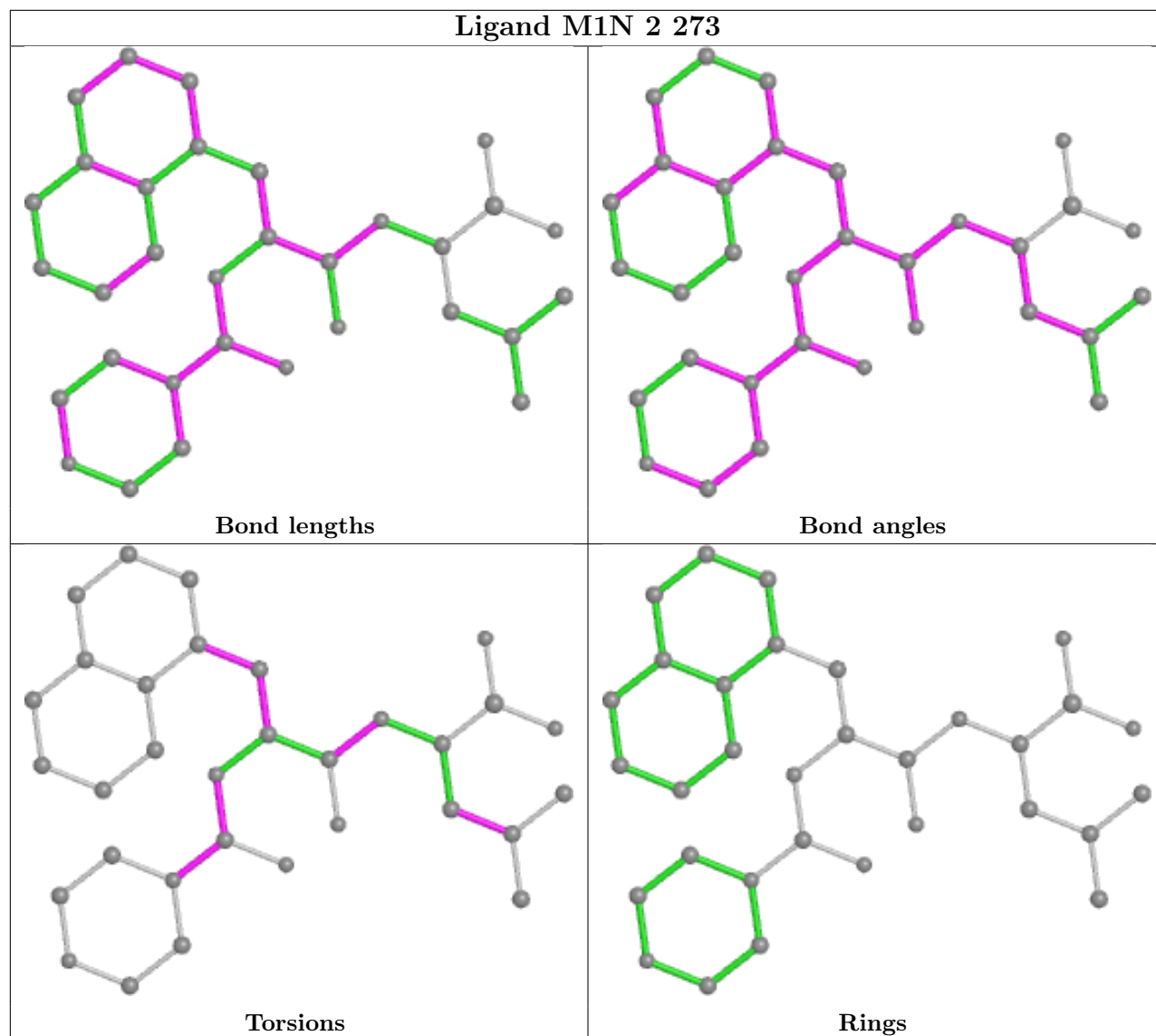

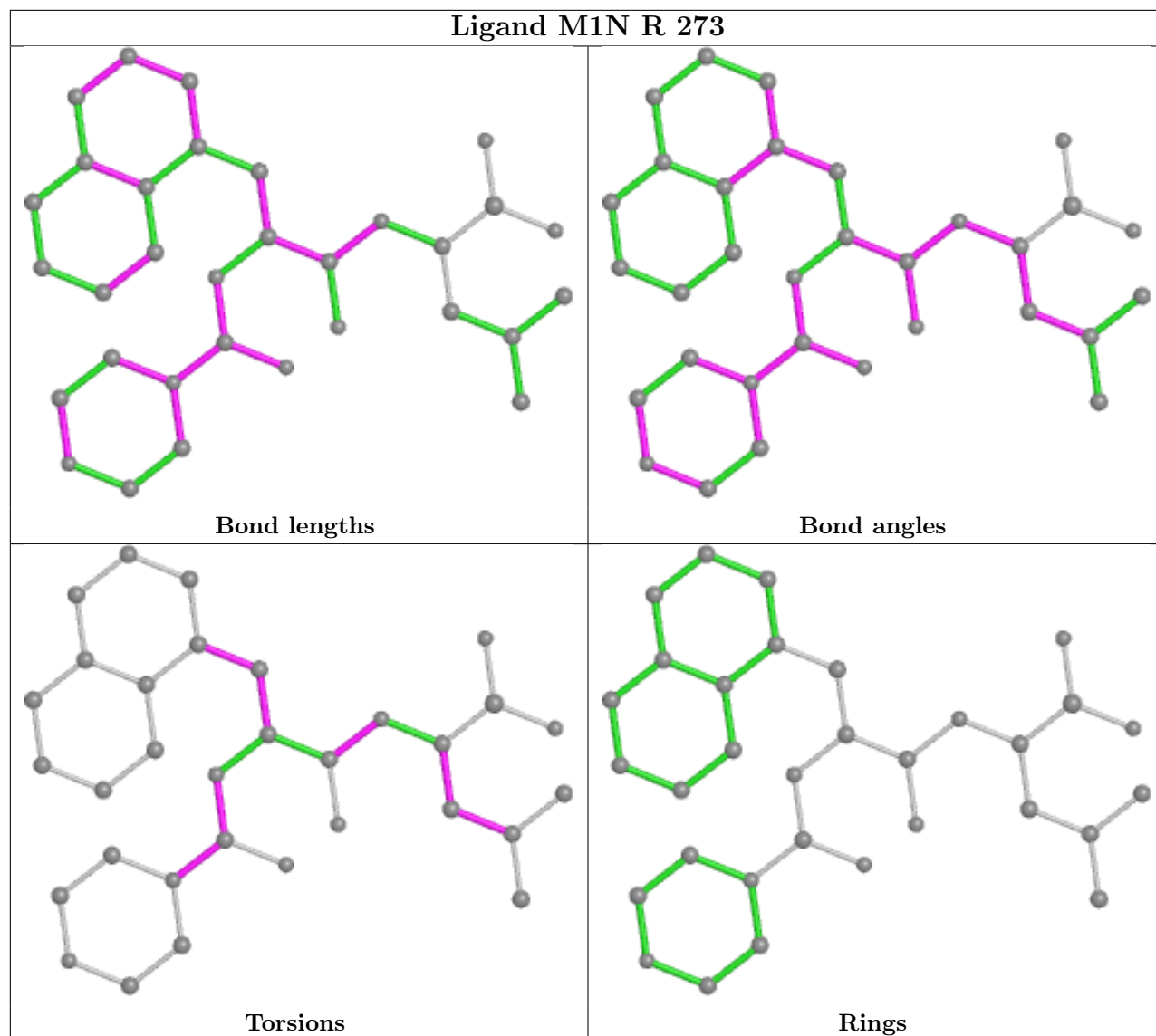

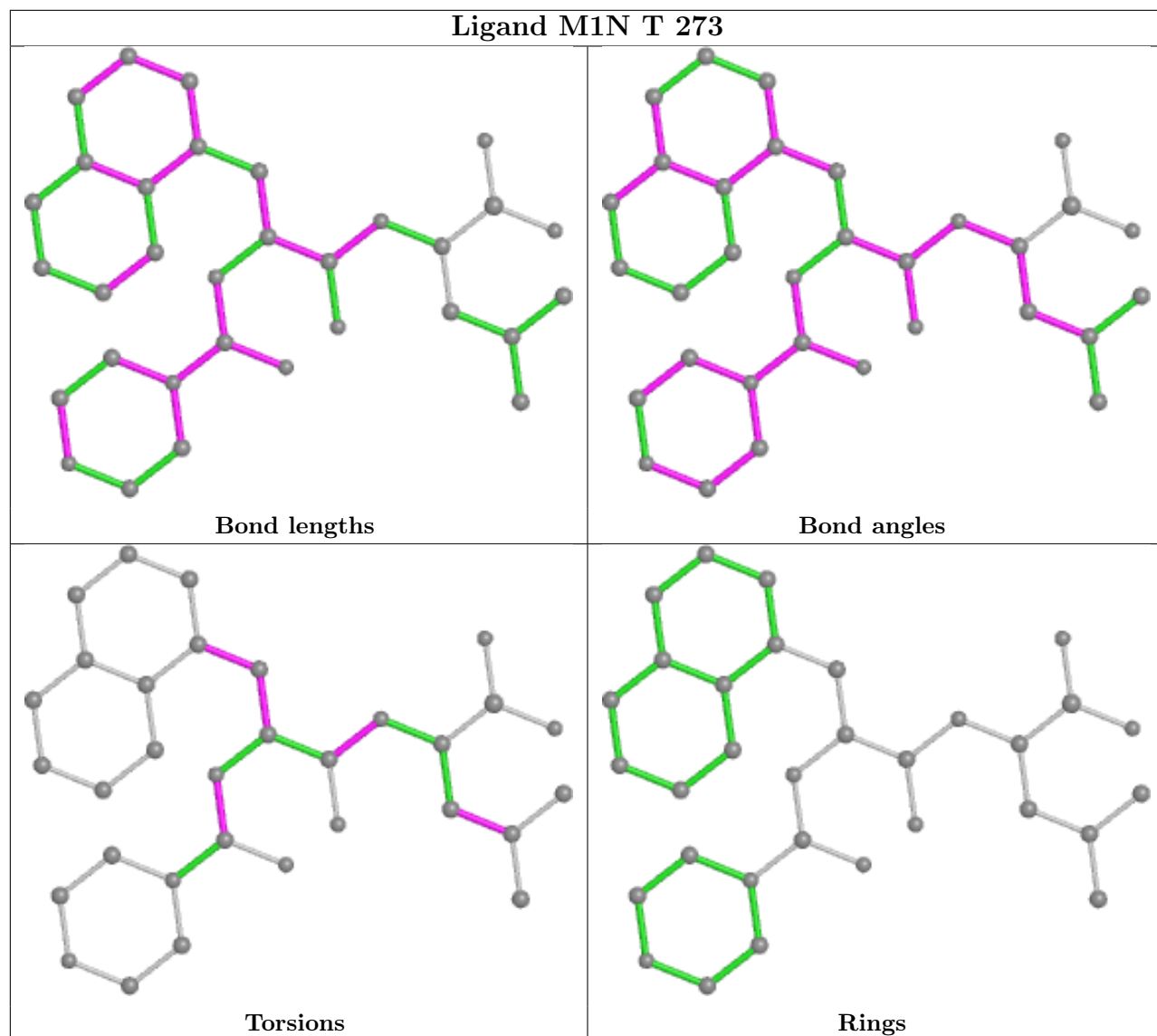

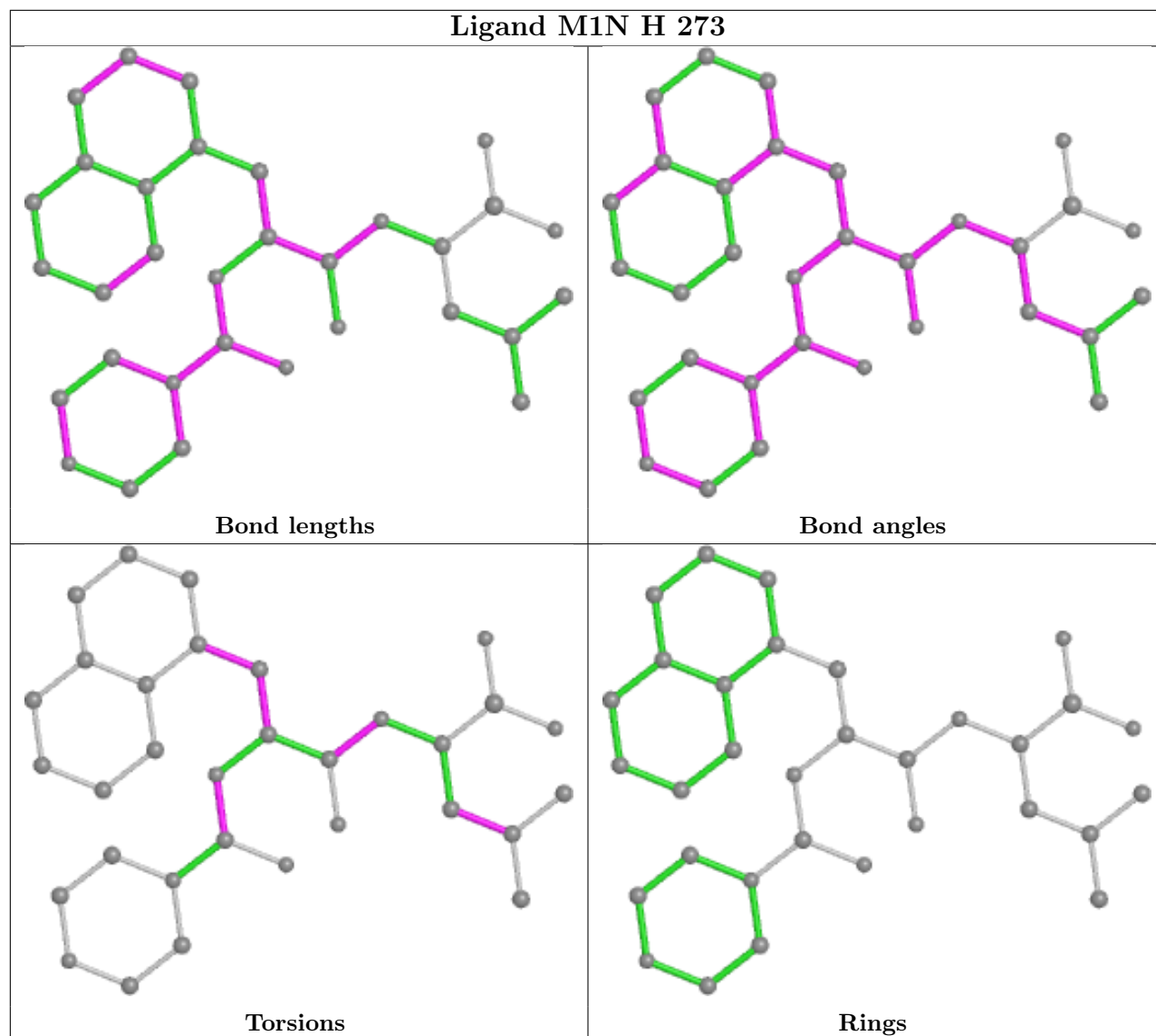

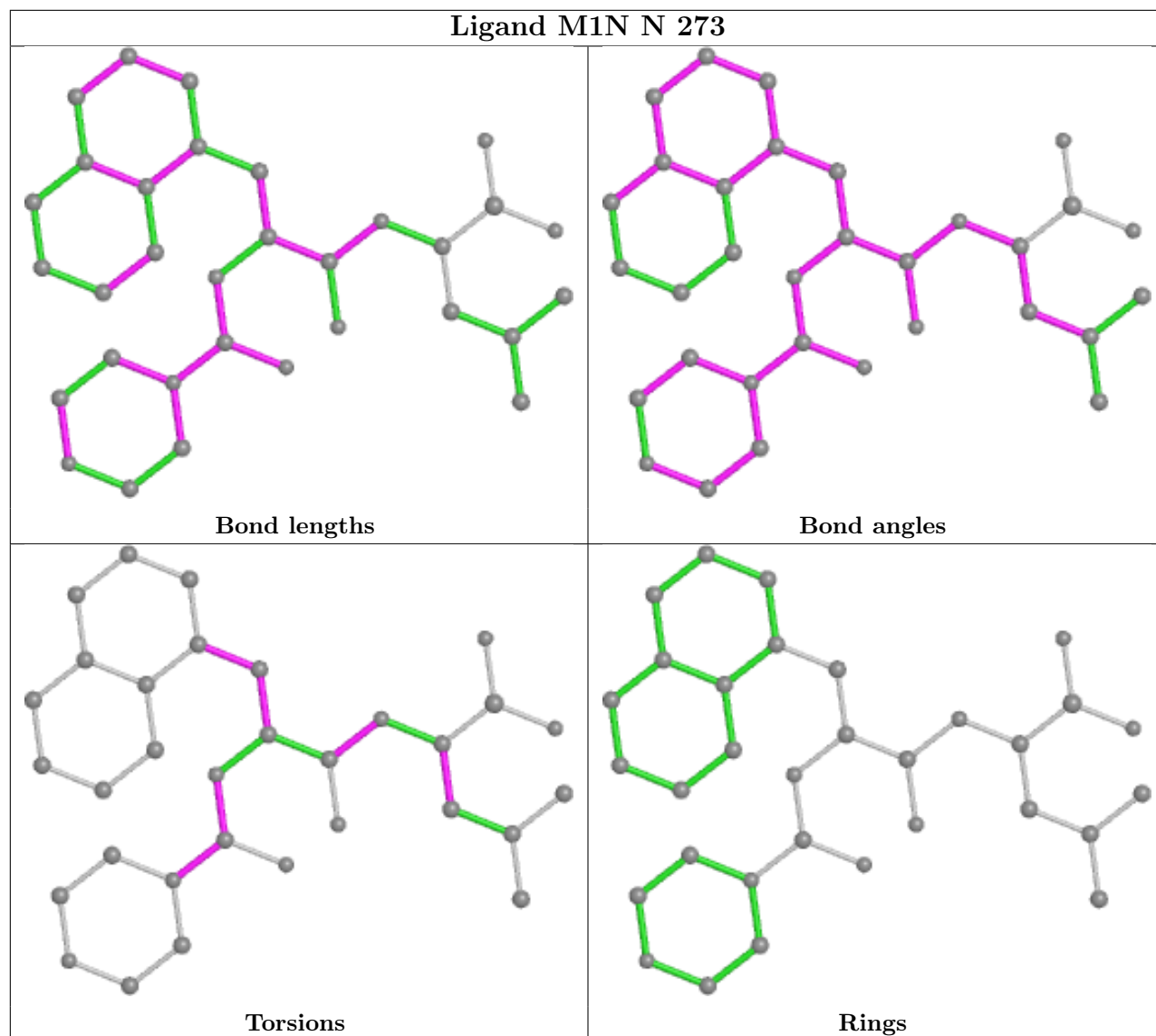

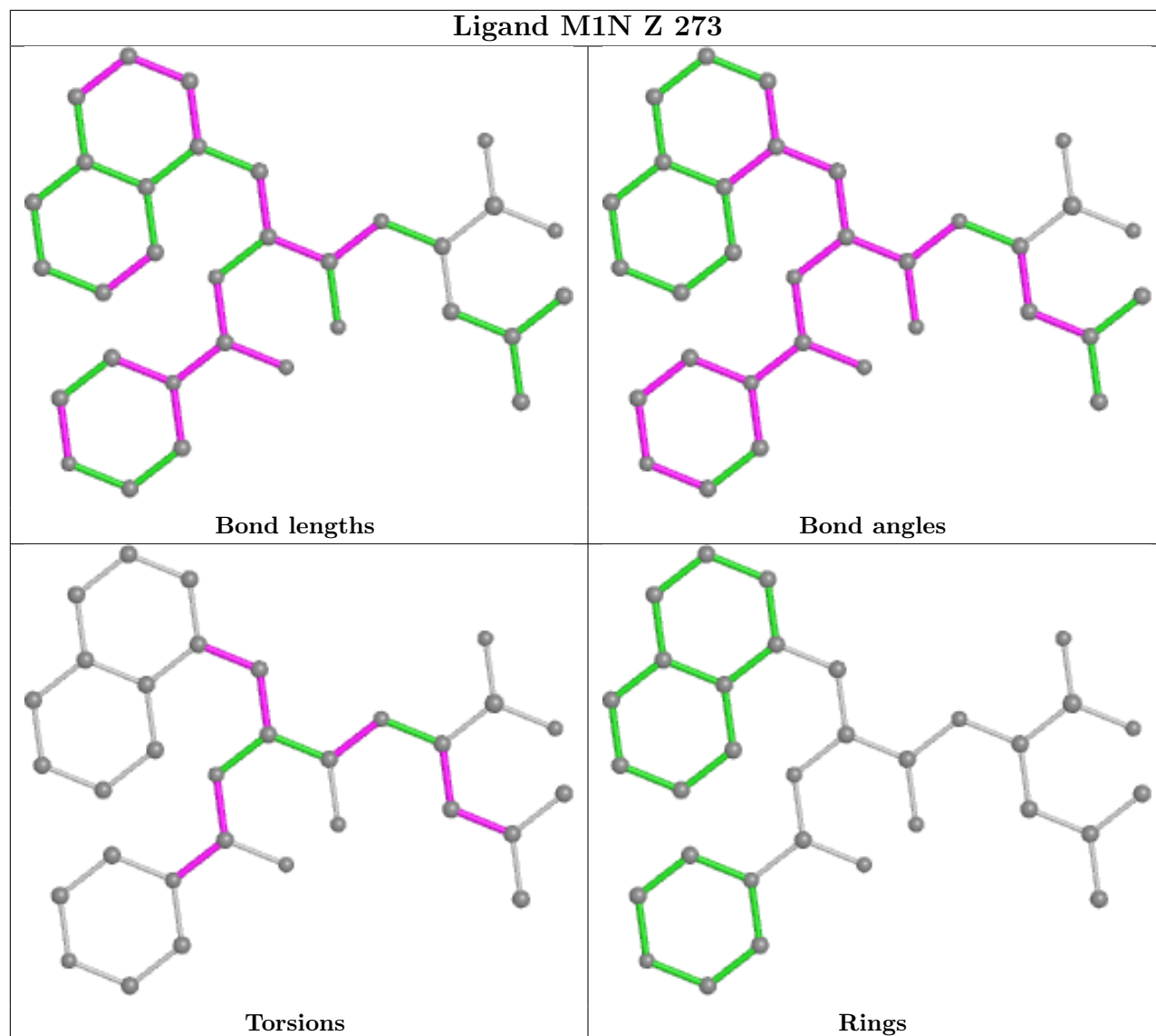

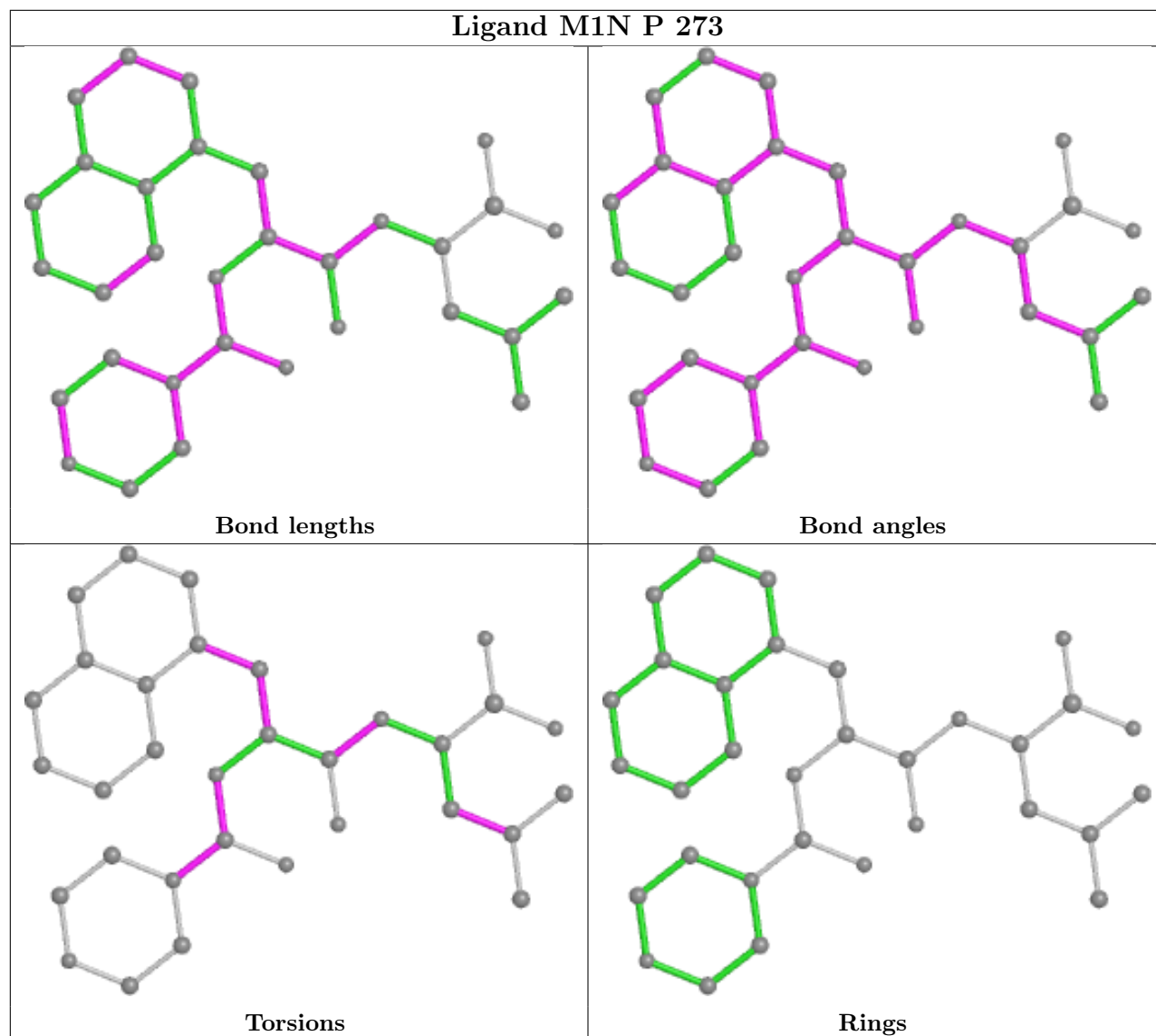

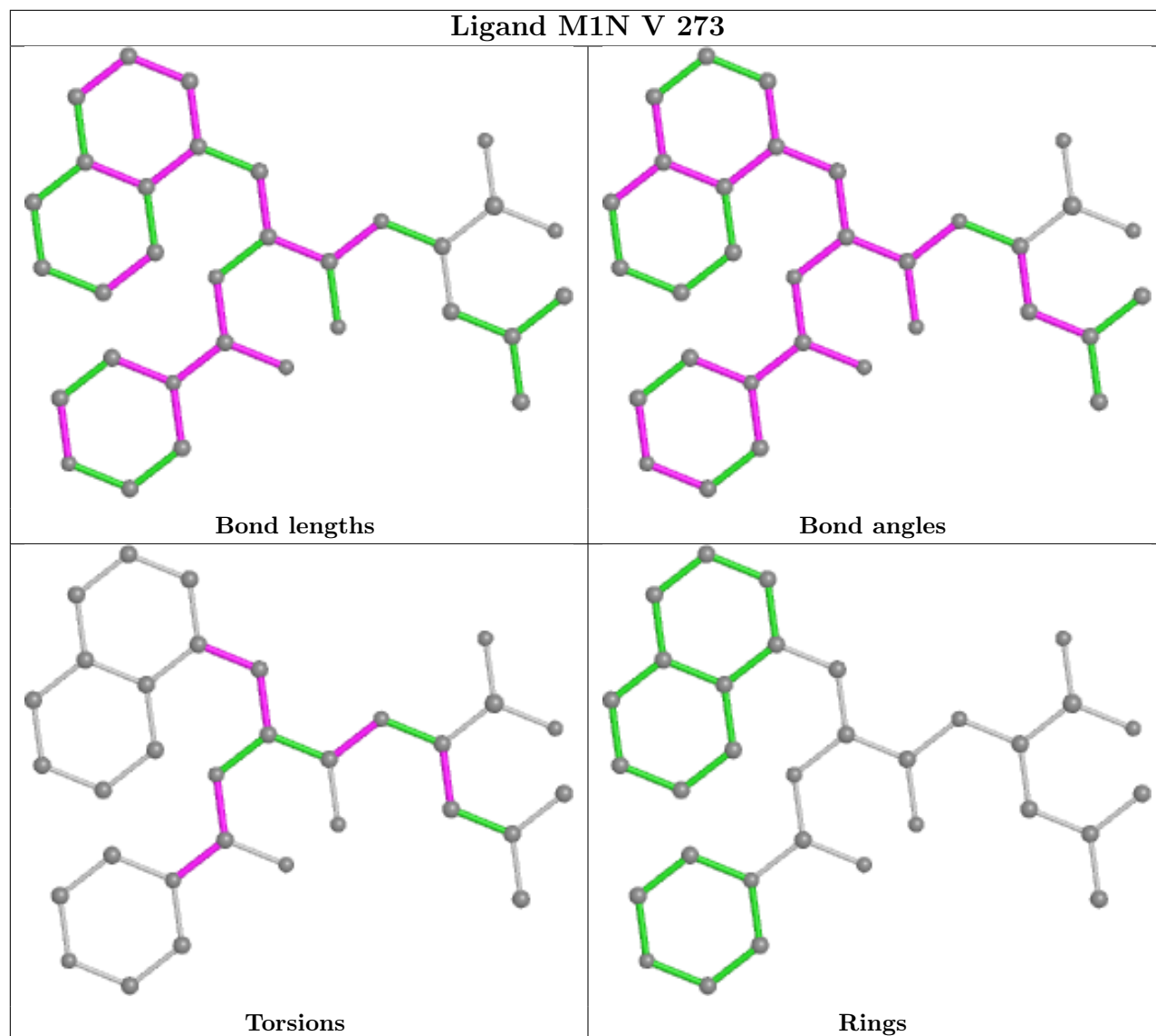

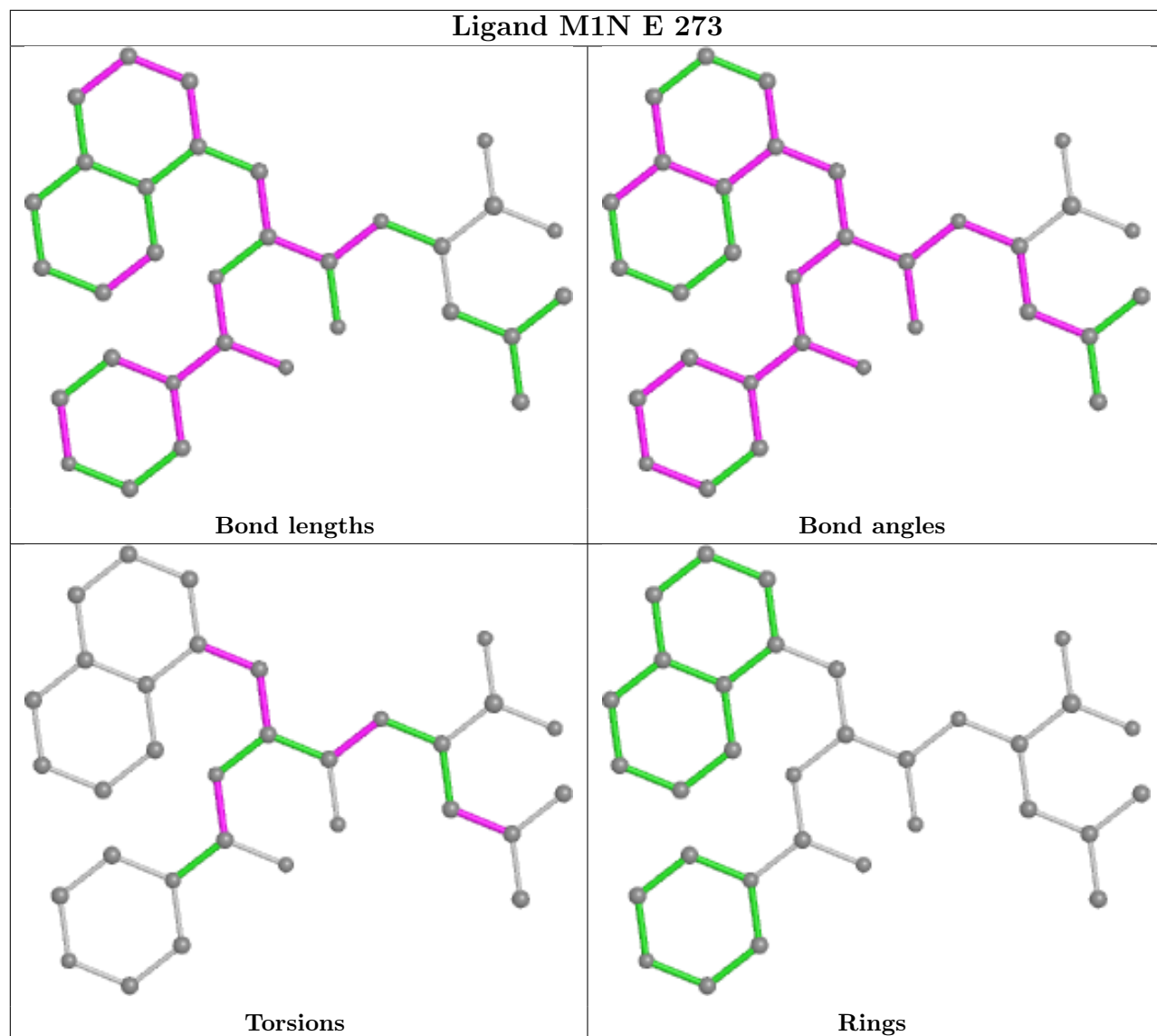

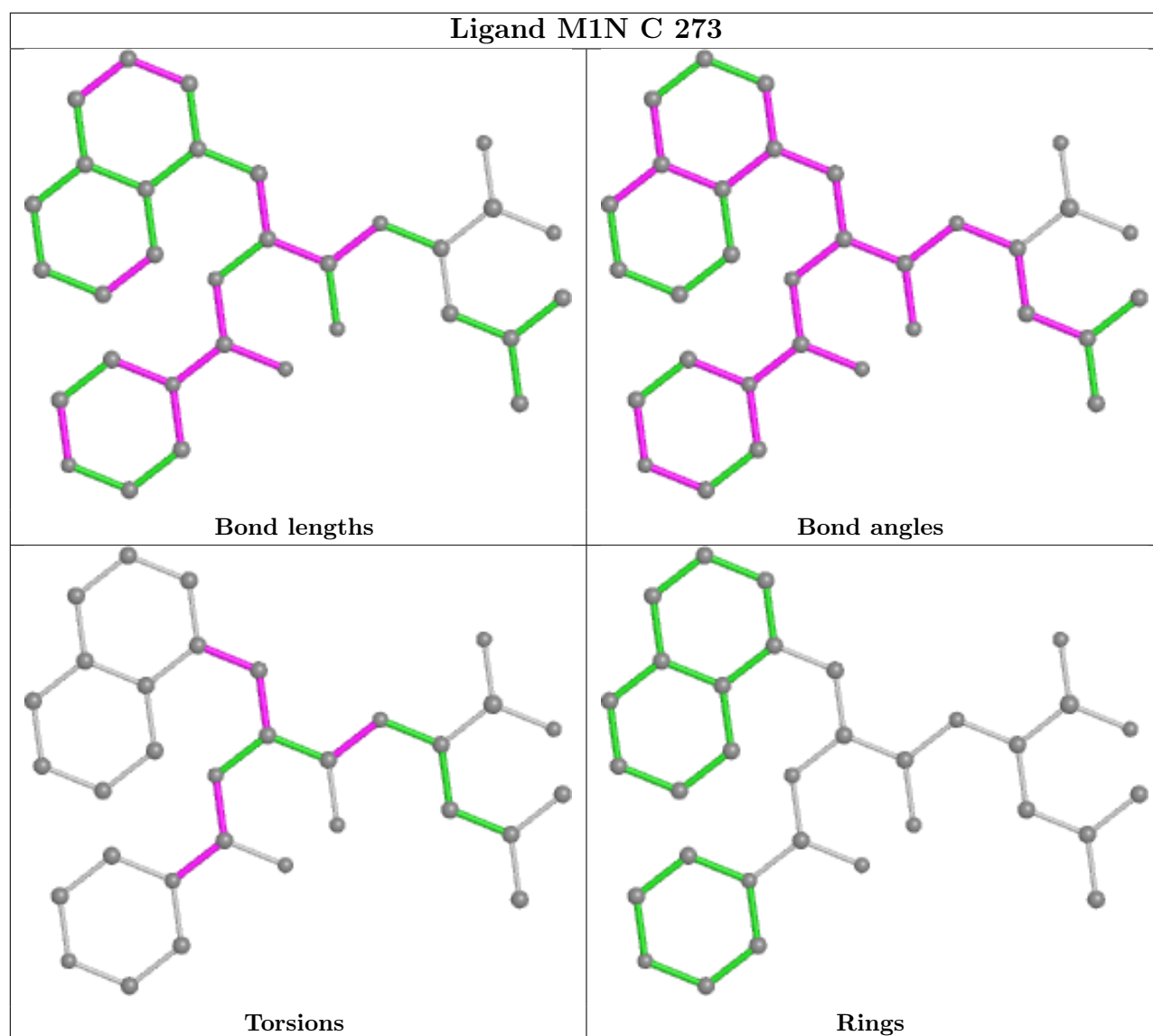

5.7 Other polymers [i](#)

There are no such residues in this entry.

5.8 Polymer linkage issues [i](#)

There are no chain breaks in this entry.

6 Fit of model and data [i](#)

6.1 Protein, DNA and RNA chains [i](#)

In the following table, the column labelled ‘#RSRZ> 2’ contains the number (and percentage) of RSRZ outliers, followed by percent RSRZ outliers for the chain as percentile scores relative to all X-ray entries and entries of similar resolution. The OWAB column contains the minimum, median, 95th percentile and maximum values of the occupancy-weighted average B-factor per residue. The column labelled ‘Q< 0.9’ lists the number of (and percentage) of residues with an average occupancy less than 0.9.

Mol	Chain	Analysed	<RSRZ>	#RSRZ>2	OWAB(Å ²)	Q<0.9
1	1	220/251 (87%)	1.34	58 (26%) 0 0	75, 100, 100, 100	0
1	A	220/251 (87%)	0.76	16 (7%) 15 4	74, 100, 100, 100	0
1	B	220/251 (87%)	0.98	29 (13%) 3 1	74, 100, 100, 100	0
1	D	220/251 (87%)	1.11	39 (17%) 1 0	74, 100, 100, 100	0
1	F	220/251 (87%)	1.09	36 (16%) 1 0	74, 100, 100, 100	0
1	I	220/251 (87%)	1.01	29 (13%) 3 1	74, 100, 100, 100	0
1	K	220/251 (87%)	1.38	45 (20%) 1 0	74, 100, 100, 100	0
1	M	220/251 (87%)	1.04	35 (15%) 1 1	74, 100, 100, 100	0
1	O	220/251 (87%)	1.35	55 (25%) 0 0	74, 100, 100, 100	0
1	Q	220/251 (87%)	1.44	64 (29%) 0 0	74, 100, 100, 100	0
1	S	220/251 (87%)	1.16	43 (19%) 1 0	74, 100, 100, 100	0
1	U	220/251 (87%)	1.23	49 (22%) 0 0	74, 100, 100, 100	0
1	W	220/251 (87%)	1.18	42 (19%) 1 0	74, 100, 100, 100	0
1	Y	220/251 (87%)	1.68	81 (36%) 0 0	74, 100, 100, 100	0
2	2	222/240 (92%)	0.49	17 (7%) 13 4	52, 72, 91, 100	0
2	C	222/240 (92%)	0.58	2 (0%) 84 63	53, 72, 91, 100	0
2	E	222/240 (92%)	0.46	7 (3%) 47 20	52, 72, 92, 100	0
2	G	222/240 (92%)	0.37	6 (2%) 54 26	52, 72, 91, 100	0
2	H	222/240 (92%)	0.54	2 (0%) 84 63	52, 72, 91, 100	0
2	J	222/240 (92%)	0.43	7 (3%) 47 20	53, 72, 92, 100	0
2	L	222/240 (92%)	0.47	2 (0%) 84 63	53, 72, 92, 100	0
2	N	222/240 (92%)	0.39	5 (2%) 60 31	52, 72, 91, 100	0
2	P	222/240 (92%)	0.41	2 (0%) 84 63	53, 72, 91, 100	0
2	R	222/240 (92%)	0.47	12 (5%) 25 9	53, 72, 92, 100	0

Continued on next page...

Continued from previous page...

Mol	Chain	Analysed	<RSRZ>	#RSRZ>2	OWAB(Å ²)	Q<0.9
2	T	222/240 (92%)	0.50	12 (5%) 25 9	53, 72, 92, 100	0
2	V	222/240 (92%)	0.43	5 (2%) 60 31	53, 72, 92, 100	0
2	X	222/240 (92%)	0.51	14 (6%) 20 6	53, 72, 91, 100	0
2	Z	222/240 (92%)	0.41	6 (2%) 54 26	53, 72, 92, 100	0
All	All	6188/6874 (90%)	0.83	720 (11%) 4 1	52, 88, 100, 100	0

The worst 5 of 720 RSRZ outliers are listed below:

Mol	Chain	Res	Type	RSRZ
1	K	235	VAL	21.3
1	K	236	ASP	19.4
1	S	235	VAL	17.4
1	W	235	VAL	14.7
1	W	236	ASP	14.6

6.2 Non-standard residues in protein, DNA, RNA chains [i](#)

There are no non-standard protein/DNA/RNA residues in this entry.

6.3 Carbohydrates [i](#)

There are no monosaccharides in this entry.

6.4 Ligands [i](#)

In the following table, the Atoms column lists the number of modelled atoms in the group and the number defined in the chemical component dictionary. The B-factors column lists the minimum, median, 95th percentile and maximum values of B factors of atoms in the group. The column labelled 'Q< 0.9' lists the number of atoms with occupancy less than 0.9.

Mol	Type	Chain	Res	Atoms	RSCC	RSR	B-factors(Å ²)	Q<0.9
3	M1N	2	273	32/32	0.84	0.30	65,76,78,79	0
3	M1N	T	273	32/32	0.85	0.30	64,77,78,79	0
3	M1N	V	273	32/32	0.85	0.30	65,76,78,78	0
3	M1N	P	273	32/32	0.85	0.24	65,76,78,79	0
3	M1N	J	273	32/32	0.86	0.31	64,76,77,78	0
3	M1N	X	273	32/32	0.87	0.31	65,76,78,79	0
3	M1N	Z	273	32/32	0.88	0.24	66,76,78,78	0

Continued on next page...

Continued from previous page...

Mol	Type	Chain	Res	Atoms	RSCC	RSR	B-factors(\AA^2)	Q<0.9
3	M1N	E	273	32/32	0.89	0.26	63,76,78,78	0
3	M1N	G	273	32/32	0.89	0.21	64,75,77,78	0
3	M1N	C	273	32/32	0.89	0.24	63,75,77,78	0
3	M1N	R	273	32/32	0.90	0.24	64,76,78,78	0
3	M1N	L	273	32/32	0.91	0.24	65,75,77,78	0
3	M1N	N	273	32/32	0.91	0.24	65,76,77,78	0
3	M1N	H	273	32/32	0.91	0.25	64,75,77,78	0

The following is a graphical depiction of the model fit to experimental electron density of all instances of the Ligand of Interest. In addition, ligands with molecular weight > 250 and outliers as shown on the geometry validation Tables will also be included. Each fit is shown from different orientation to approximate a three-dimensional view.

Electron density around M1N 2 273:

$2mF_o-DF_c$ (at 0.7 rmsd) in gray
 mF_o-DF_c (at 3 rmsd) in purple (negative)
and green (positive)

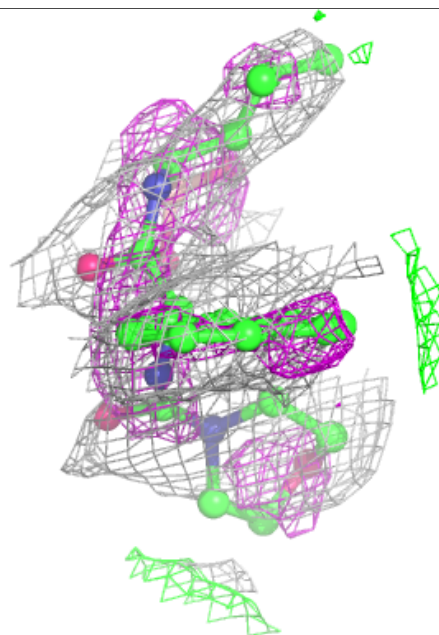
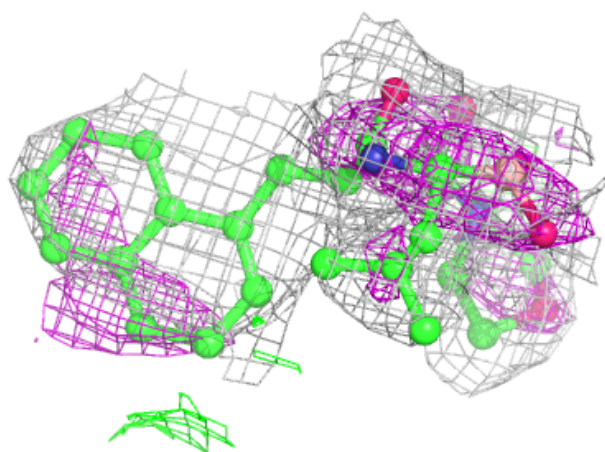
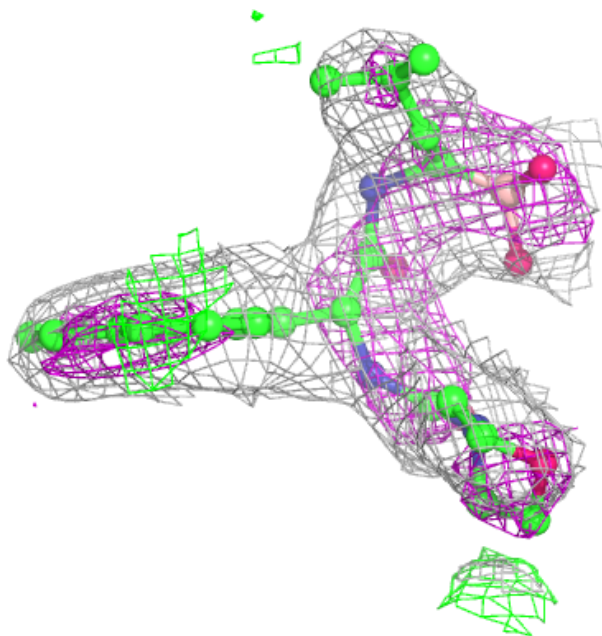

Electron density around M1N T 273:

$2mF_o-DF_c$ (at 0.7 rmsd) in gray
 mF_o-DF_c (at 3 rmsd) in purple (negative)
and green (positive)

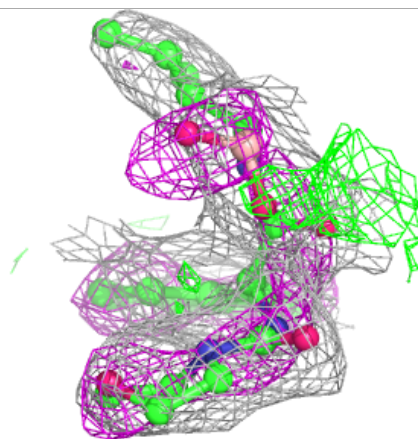
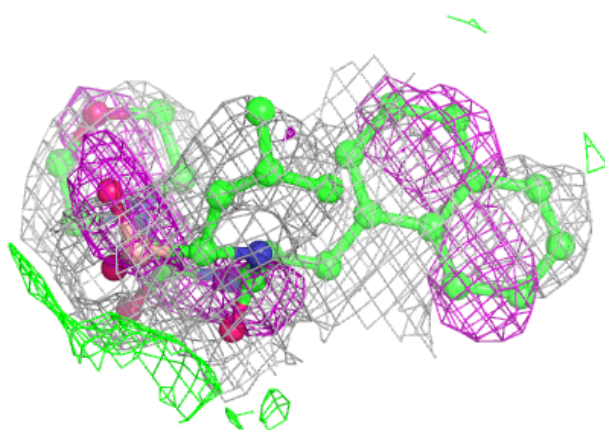
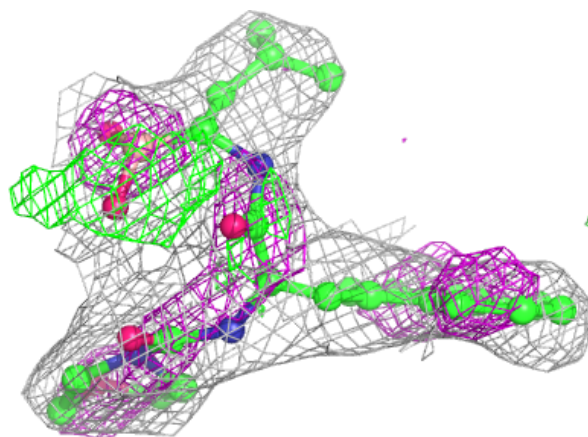

Electron density around M1N V 273:

$2mF_o-DF_c$ (at 0.7 rmsd) in gray
 mF_o-DF_c (at 3 rmsd) in purple (negative)
and green (positive)

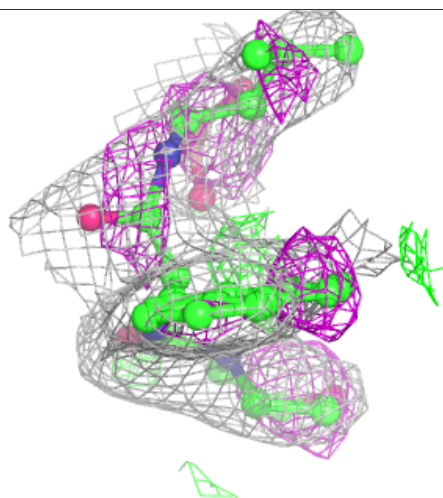
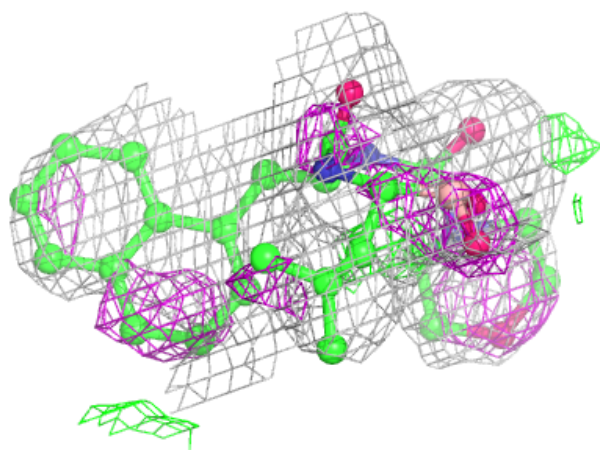
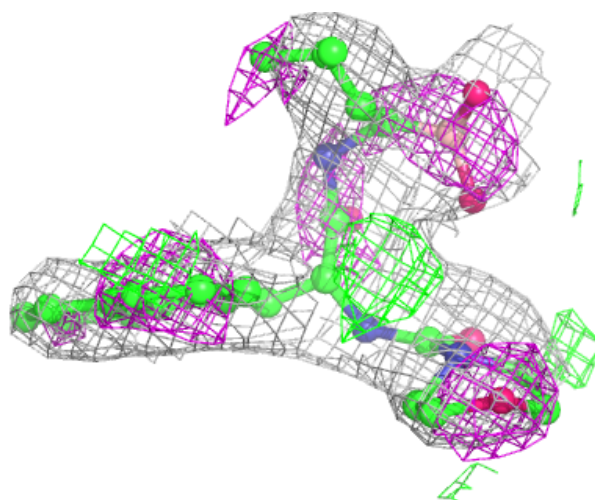

Electron density around M1N P 273:

$2mF_o-DF_c$ (at 0.7 rmsd) in gray
 mF_o-DF_c (at 3 rmsd) in purple (negative)
and green (positive)

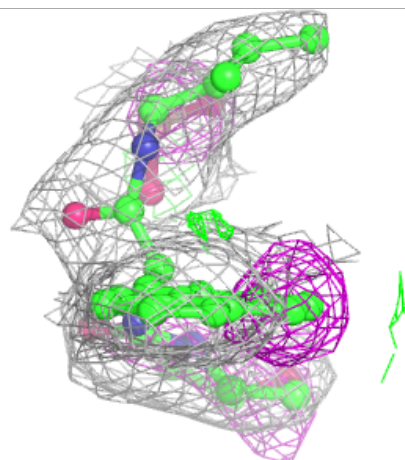
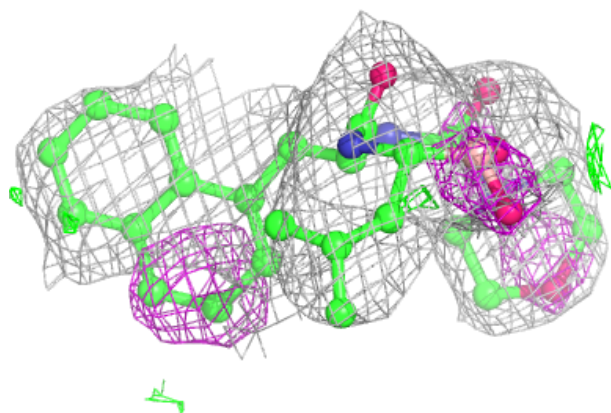
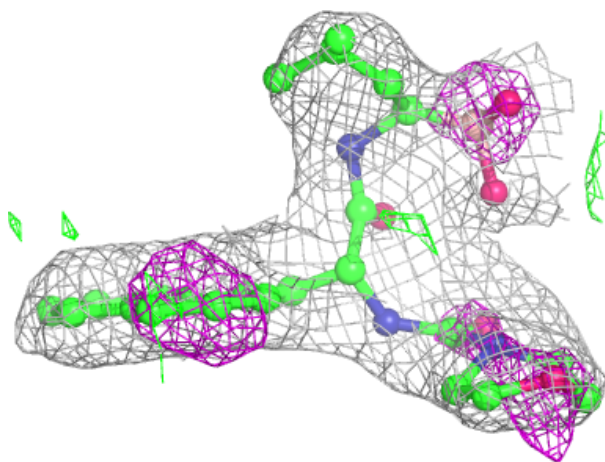

Electron density around M1N J 273:

$2mF_o-DF_c$ (at 0.7 rmsd) in gray
 mF_o-DF_c (at 3 rmsd) in purple (negative)
and green (positive)

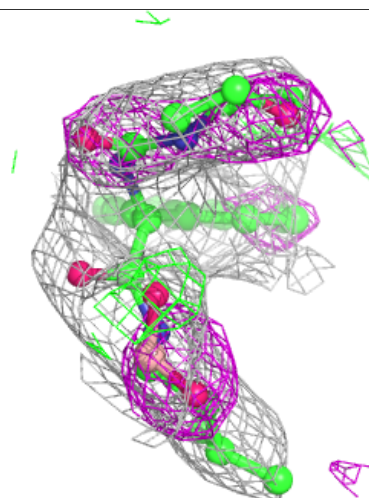
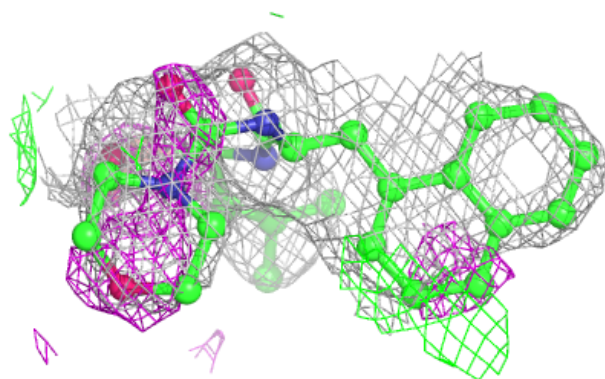
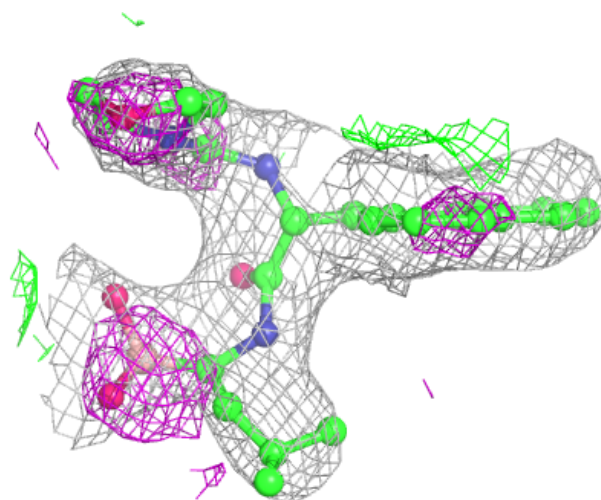

Electron density around M1N X 273:

$2mF_o-DF_c$ (at 0.7 rmsd) in gray
 mF_o-DF_c (at 3 rmsd) in purple (negative)
and green (positive)

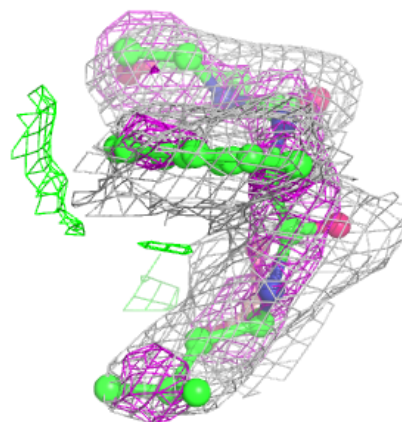
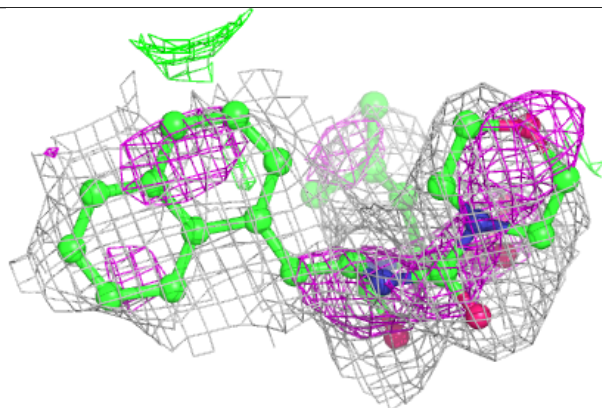
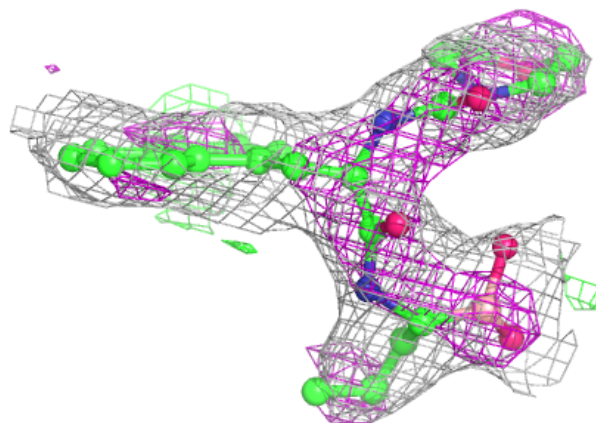

Electron density around M1N Z 273:

$2mF_o-DF_c$ (at 0.7 rmsd) in gray
 mF_o-DF_c (at 3 rmsd) in purple (negative)
and green (positive)

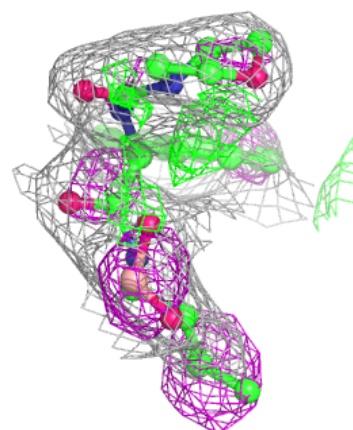
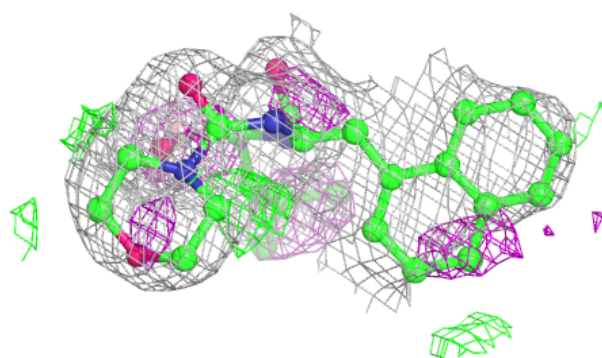
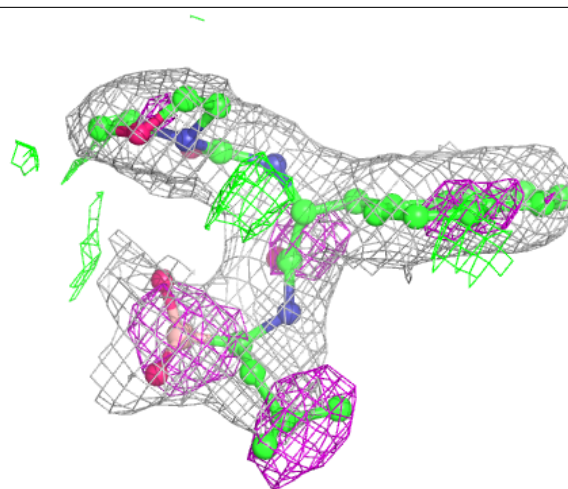

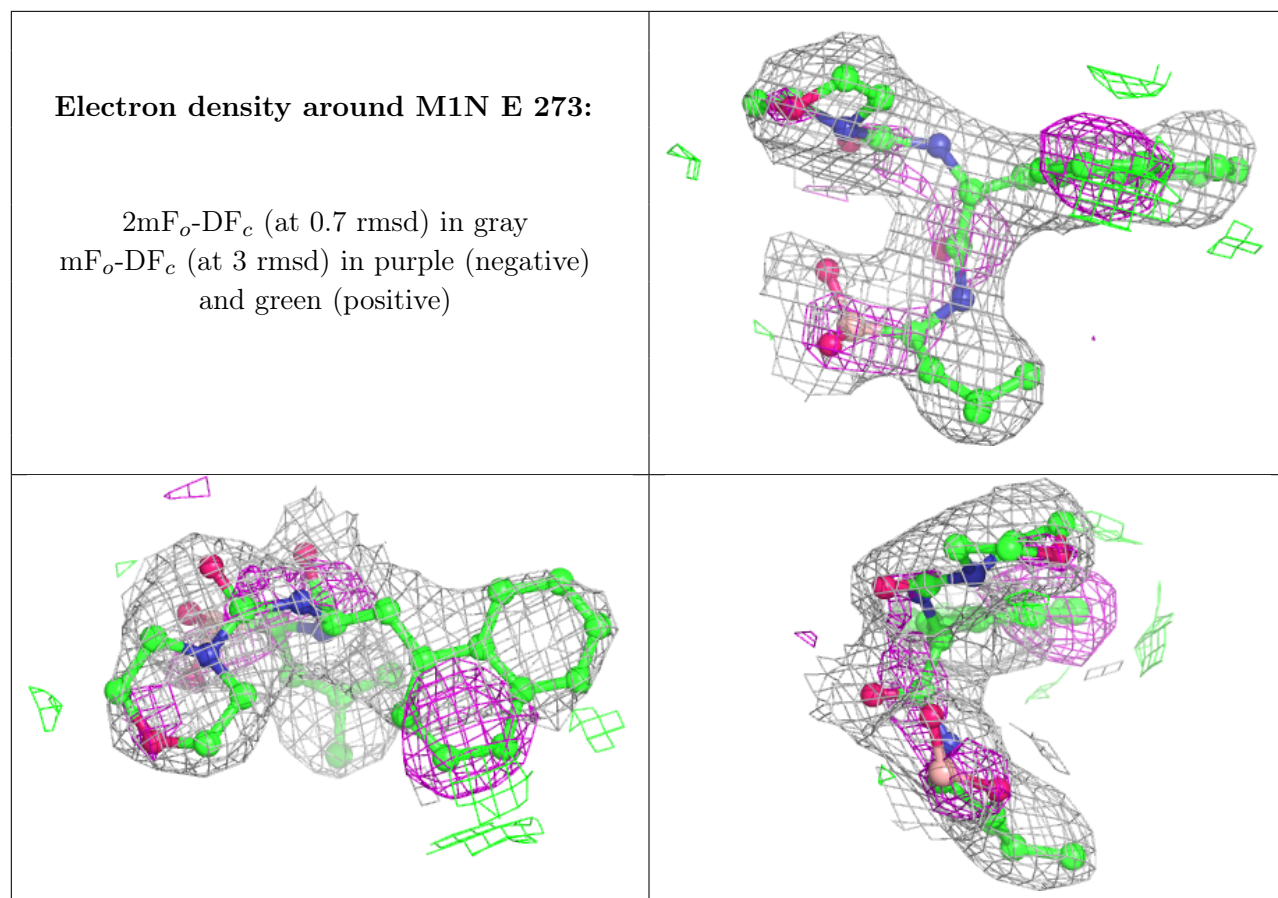

Electron density around M1N G 273:

$2mF_o-DF_c$ (at 0.7 rmsd) in gray
 mF_o-DF_c (at 3 rmsd) in purple (negative)
and green (positive)

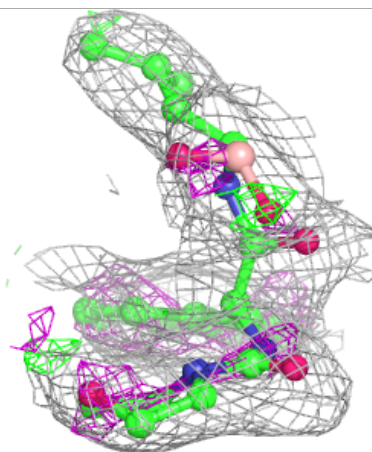
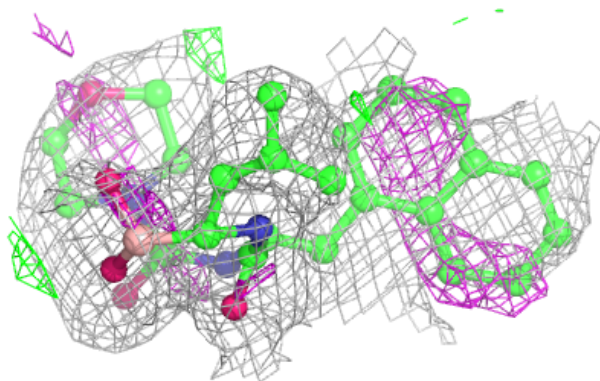
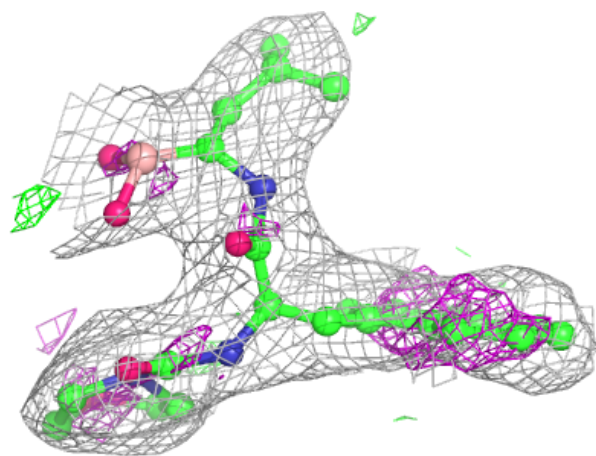

Electron density around M1N C 273:

$2mF_o-DF_c$ (at 0.7 rmsd) in gray
 mF_o-DF_c (at 3 rmsd) in purple (negative)
and green (positive)

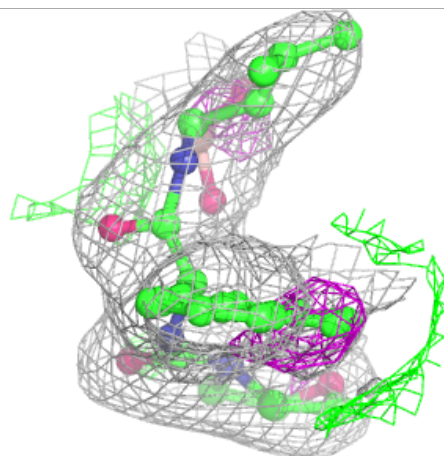
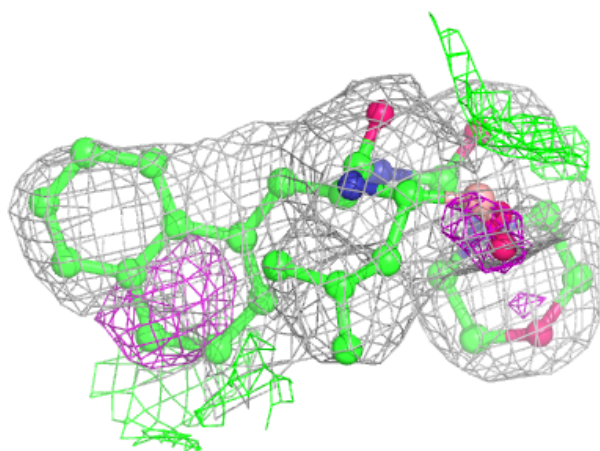
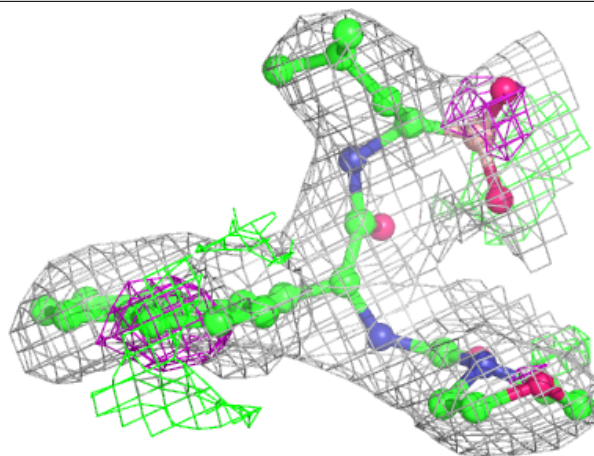

Electron density around M1N R 273:

$2mF_o-DF_c$ (at 0.7 rmsd) in gray
 mF_o-DF_c (at 3 rmsd) in purple (negative)
and green (positive)

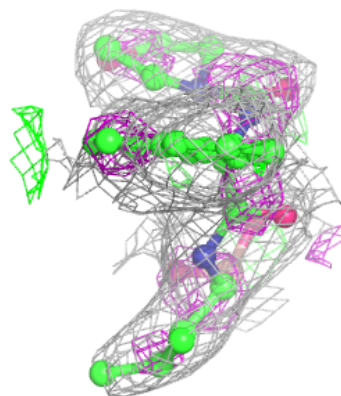
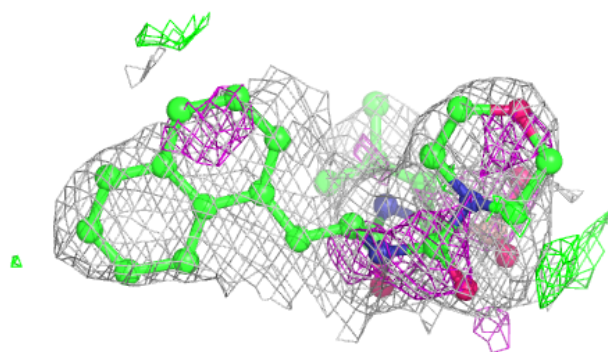
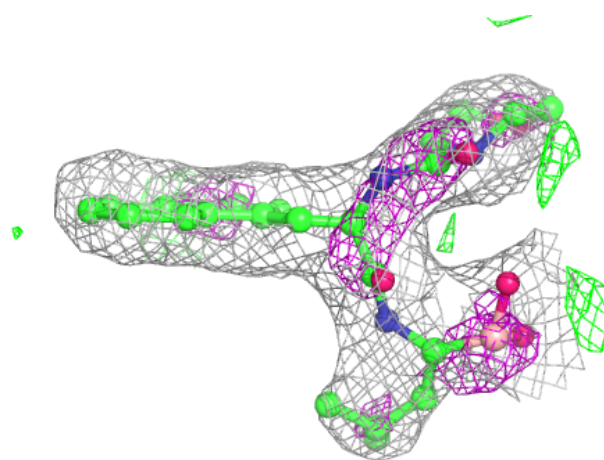

Electron density around M1N L 273:

$2mF_o-DF_c$ (at 0.7 rmsd) in gray
 mF_o-DF_c (at 3 rmsd) in purple (negative)
and green (positive)

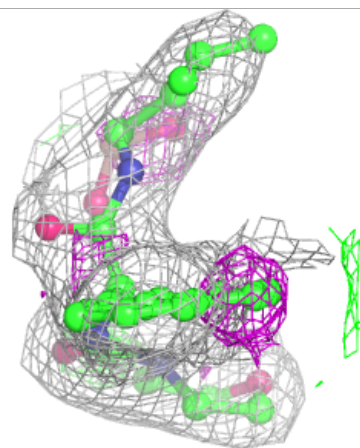
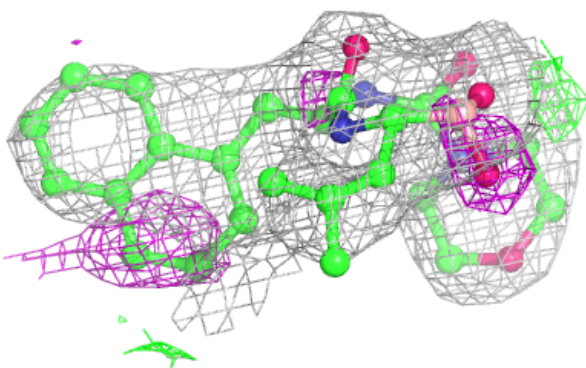
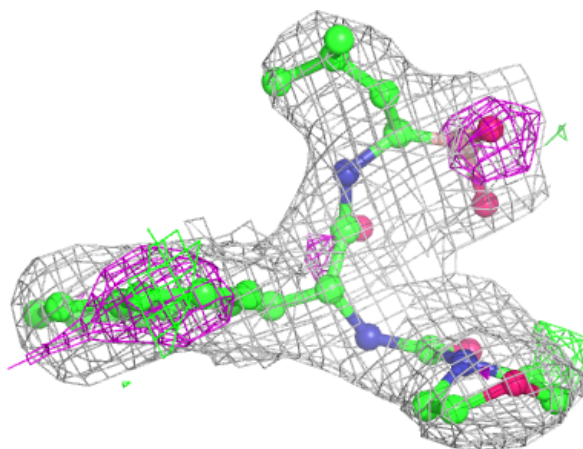

Electron density around M1N N 273:

$2mF_o-DF_c$ (at 0.7 rmsd) in gray
 mF_o-DF_c (at 3 rmsd) in purple (negative)
and green (positive)

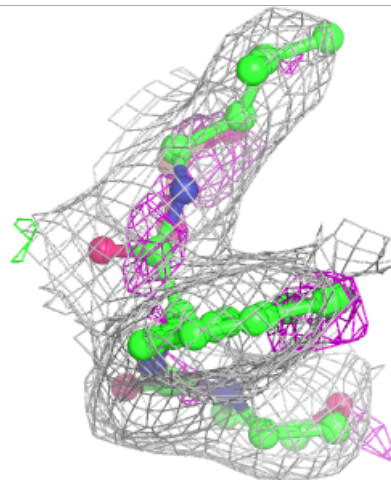
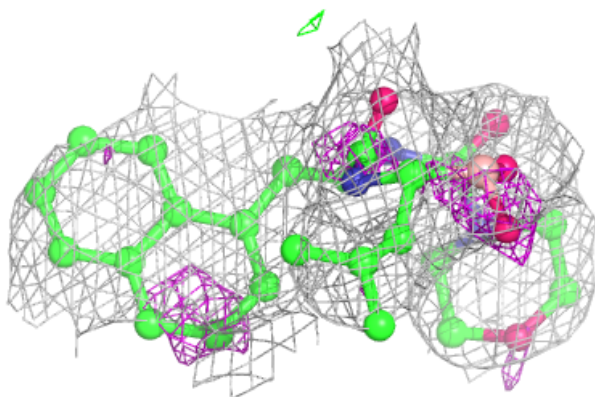
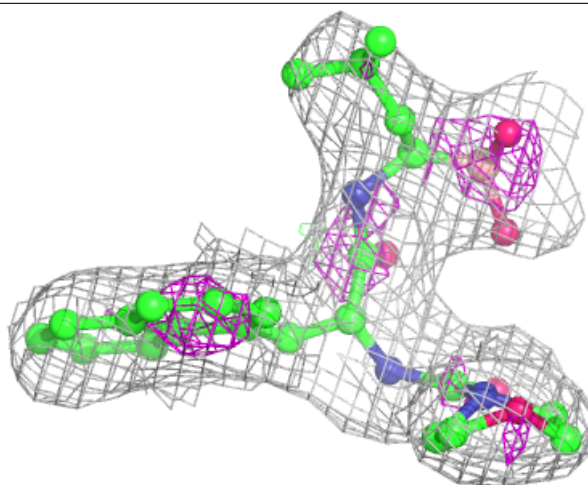

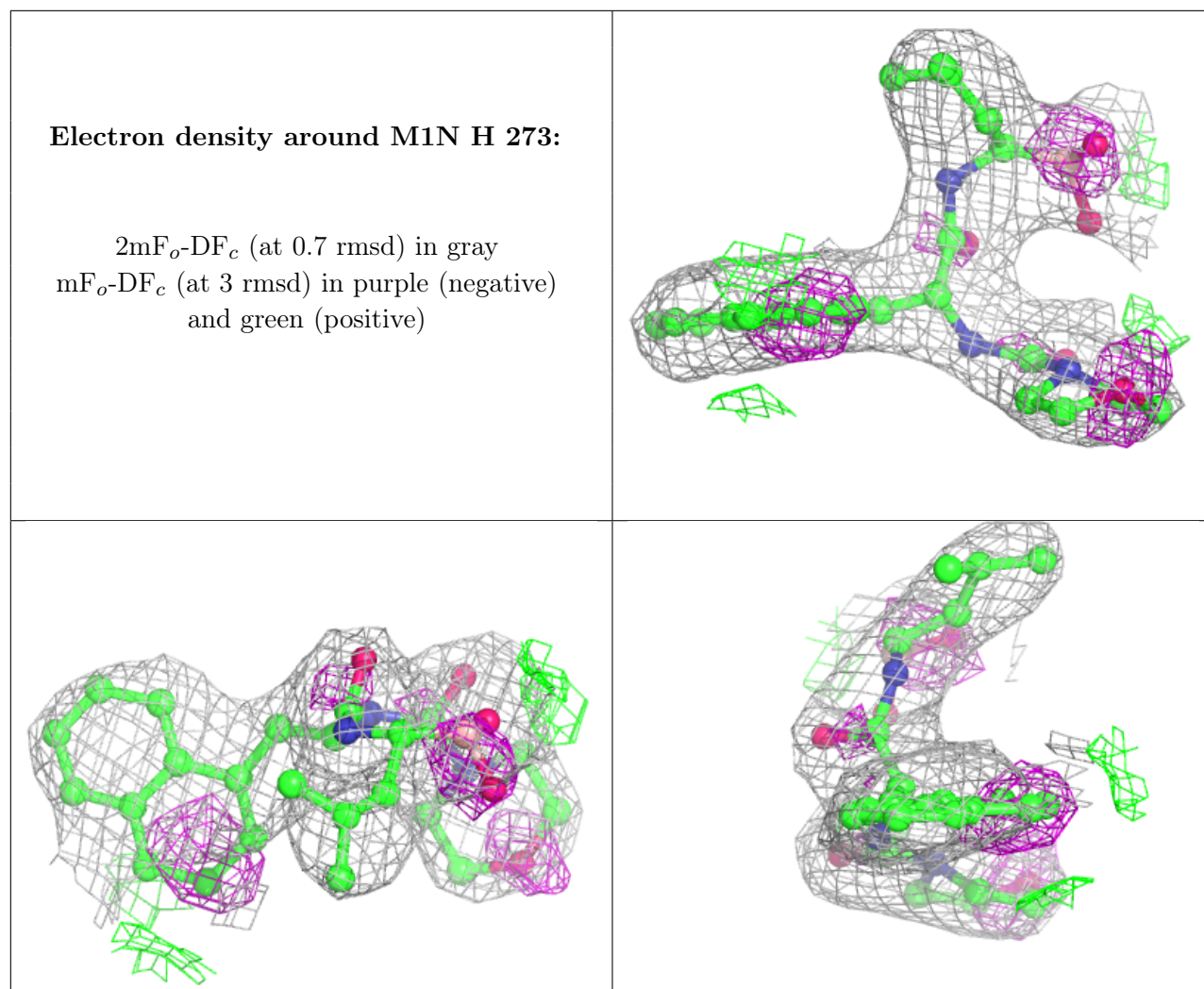

6.5 Other polymers [i](#)

There are no such residues in this entry.