



wwPDB X-ray Structure Validation Summary Report

Jan 24, 2021 – 02:03 PM EST

PDB ID : 3CDX
Title : Crystal structure of succinylglutamatedesuccinylase/aspartoacylase from *Rhodobacter sphaeroides*
Authors : Bonanno, J.B.; Rutter, M.; Bain, K.T.; Iizuka, M.; Patterson, K.; Smith, D.; Wasserman, S.; Sauder, J.M.; Burley, S.K.; Almo, S.C.; New York SGX Research Center for Structural Genomics (NYSGXRC)
Deposited on : 2008-02-27
Resolution : 2.10 Å (reported)

This is a wwPDB X-ray Structure Validation Summary Report for a publicly released PDB entry.

We welcome your comments at validation@mail.wwpdb.org

A user guide is available at

<https://www.wwpdb.org/validation/2017/XrayValidationReportHelp>

with specific help available everywhere you see the  symbol.

The following versions of software and data (see [references](#) ) were used in the production of this report:

MolProbity : 4.02b-467
Xtriage (Phenix) : 1.13
EDS : 2.16
Percentile statistics : 20191225.v01 (using entries in the PDB archive December 25th 2019)
Refmac : 5.8.0158
CCP4 : 7.0.044 (Gargrove)
Ideal geometry (proteins) : Engh & Huber (2001)
Ideal geometry (DNA, RNA) : Parkinson et al. (1996)
Validation Pipeline (wwPDB-VP) : 2.16

1 Overall quality at a glance

The following experimental techniques were used to determine the structure:

X-RAY DIFFRACTION

The reported resolution of this entry is 2.10 Å.

Percentile scores (ranging between 0-100) for global validation metrics of the entry are shown in the following graphic. The table shows the number of entries on which the scores are based.

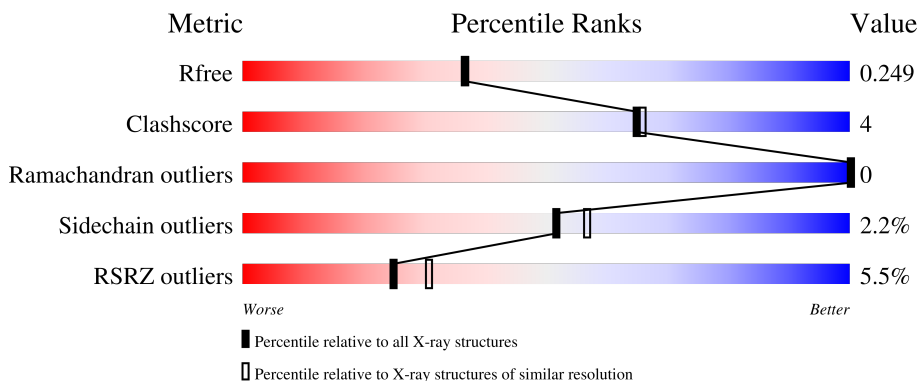

Metric	Whole archive (#Entries)	Similar resolution (#Entries, resolution range(Å))
R_{free}	130704	5197 (2.10-2.10)
Clashscore	141614	5710 (2.10-2.10)
Ramachandran outliers	138981	5647 (2.10-2.10)
Sidechain outliers	138945	5648 (2.10-2.10)
RSRZ outliers	127900	5083 (2.10-2.10)

The table below summarises the geometric issues observed across the polymeric chains and their fit to the electron density. The red, orange, yellow and green segments of the lower bar indicate the fraction of residues that contain outliers for ≥ 3 , 2, 1 and 0 types of geometric quality criteria respectively. A grey segment represents the fraction of residues that are not modelled. The numeric value for each fraction is indicated below the corresponding segment, with a dot representing fractions $\leq 5\%$. The upper red bar (where present) indicates the fraction of residues that have poor fit to the electron density. The numeric value is given above the bar.

Mol	Chain	Length	Quality of chain
1	A	354	 3% 85% 8% 7%
1	B	354	 3% 84% 8% 7%
1	C	354	 3% 83% 8% 8%
1	D	354	 12% 78% 13% 9%
1	E	354	 7% 84% 8% 8%

Continued on next page...

Continued from previous page...

Mol	Chain	Length	Quality of chain
1	F	354	 <p>A horizontal bar chart representing the quality of chain. The bar is divided into four segments: a small red segment on the left labeled '3%', a large green segment labeled '82%', a yellow segment labeled '10%', and a small grey segment on the right labeled '7%'.</p>

2 Entry composition i

There are 3 unique types of molecules in this entry. The entry contains 16156 atoms, of which 0 are hydrogens and 0 are deuteriums.

In the tables below, the ZeroOcc column contains the number of atoms modelled with zero occupancy, the AltConf column contains the number of residues with at least one atom in alternate conformation and the Trace column contains the number of residues modelled with at most 2 atoms.

- Molecule 1 is a protein called Succinylglutamatedesuccinylase/aspartoacylase.

Mol	Chain	Residues	Atoms					ZeroOcc	AltConf	Trace
			Total	C	N	O	S			
1	A	329	2493	1557	451	471	14	0	2	0
1	B	328	2503	1559	456	474	14	0	4	0
1	C	325	2476	1547	449	466	14	0	4	0
1	D	322	2432	1515	443	460	14	0	1	0
1	E	326	2472	1544	447	467	14	0	1	0
1	F	328	2518	1573	457	474	14	0	4	0

There are 66 discrepancies between the modelled and reference sequences:

Chain	Residue	Modelled	Actual	Comment	Reference
A	0	MET	-	expression tag	UNP Q3HKK3
A	1	SER	-	expression tag	UNP Q3HKK3
A	2	LEU	-	expression tag	UNP Q3HKK3
A	346	GLU	-	expression tag	UNP Q3HKK3
A	347	GLY	-	expression tag	UNP Q3HKK3
A	348	HIS	-	expression tag	UNP Q3HKK3
A	349	HIS	-	expression tag	UNP Q3HKK3
A	350	HIS	-	expression tag	UNP Q3HKK3
A	351	HIS	-	expression tag	UNP Q3HKK3
A	352	HIS	-	expression tag	UNP Q3HKK3
A	353	HIS	-	expression tag	UNP Q3HKK3
B	0	MET	-	expression tag	UNP Q3HKK3
B	1	SER	-	expression tag	UNP Q3HKK3
B	2	LEU	-	expression tag	UNP Q3HKK3
B	346	GLU	-	expression tag	UNP Q3HKK3
B	347	GLY	-	expression tag	UNP Q3HKK3
B	348	HIS	-	expression tag	UNP Q3HKK3

Continued on next page...

Continued from previous page...

Chain	Residue	Modelled	Actual	Comment	Reference
B	349	HIS	-	expression tag	UNP Q3HKK3
B	350	HIS	-	expression tag	UNP Q3HKK3
B	351	HIS	-	expression tag	UNP Q3HKK3
B	352	HIS	-	expression tag	UNP Q3HKK3
B	353	HIS	-	expression tag	UNP Q3HKK3
C	0	MET	-	expression tag	UNP Q3HKK3
C	1	SER	-	expression tag	UNP Q3HKK3
C	2	LEU	-	expression tag	UNP Q3HKK3
C	346	GLU	-	expression tag	UNP Q3HKK3
C	347	GLY	-	expression tag	UNP Q3HKK3
C	348	HIS	-	expression tag	UNP Q3HKK3
C	349	HIS	-	expression tag	UNP Q3HKK3
C	350	HIS	-	expression tag	UNP Q3HKK3
C	351	HIS	-	expression tag	UNP Q3HKK3
C	352	HIS	-	expression tag	UNP Q3HKK3
C	353	HIS	-	expression tag	UNP Q3HKK3
D	0	MET	-	expression tag	UNP Q3HKK3
D	1	SER	-	expression tag	UNP Q3HKK3
D	2	LEU	-	expression tag	UNP Q3HKK3
D	346	GLU	-	expression tag	UNP Q3HKK3
D	347	GLY	-	expression tag	UNP Q3HKK3
D	348	HIS	-	expression tag	UNP Q3HKK3
D	349	HIS	-	expression tag	UNP Q3HKK3
D	350	HIS	-	expression tag	UNP Q3HKK3
D	351	HIS	-	expression tag	UNP Q3HKK3
D	352	HIS	-	expression tag	UNP Q3HKK3
D	353	HIS	-	expression tag	UNP Q3HKK3
E	0	MET	-	expression tag	UNP Q3HKK3
E	1	SER	-	expression tag	UNP Q3HKK3
E	2	LEU	-	expression tag	UNP Q3HKK3
E	346	GLU	-	expression tag	UNP Q3HKK3
E	347	GLY	-	expression tag	UNP Q3HKK3
E	348	HIS	-	expression tag	UNP Q3HKK3
E	349	HIS	-	expression tag	UNP Q3HKK3
E	350	HIS	-	expression tag	UNP Q3HKK3
E	351	HIS	-	expression tag	UNP Q3HKK3
E	352	HIS	-	expression tag	UNP Q3HKK3
E	353	HIS	-	expression tag	UNP Q3HKK3
F	0	MET	-	expression tag	UNP Q3HKK3
F	1	SER	-	expression tag	UNP Q3HKK3
F	2	LEU	-	expression tag	UNP Q3HKK3
F	346	GLU	-	expression tag	UNP Q3HKK3

Continued on next page...

Continued from previous page...

Chain	Residue	Modelled	Actual	Comment	Reference
F	347	GLY	-	expression tag	UNP Q3HKK3
F	348	HIS	-	expression tag	UNP Q3HKK3
F	349	HIS	-	expression tag	UNP Q3HKK3
F	350	HIS	-	expression tag	UNP Q3HKK3
F	351	HIS	-	expression tag	UNP Q3HKK3
F	352	HIS	-	expression tag	UNP Q3HKK3
F	353	HIS	-	expression tag	UNP Q3HKK3

- Molecule 2 is CALCIUM ION (three-letter code: CA) (formula: Ca).

Mol	Chain	Residues	Atoms	ZeroOcc	AltConf
2	D	1	Total Ca 1 1	0	0
2	E	1	Total Ca 1 1	0	0
2	B	1	Total Ca 1 1	0	0
2	C	1	Total Ca 1 1	0	0
2	A	1	Total Ca 1 1	0	0
2	F	1	Total Ca 1 1	0	0

- Molecule 3 is water.

Mol	Chain	Residues	Atoms	ZeroOcc	AltConf
3	A	243	Total O 243 243	0	0
3	B	244	Total O 244 244	0	0
3	C	210	Total O 210 210	0	0
3	D	152	Total O 152 152	0	0
3	E	174	Total O 174 174	0	0
3	F	233	Total O 233 233	0	0

3 Residue-property plots [i](#)

These plots are drawn for all protein, RNA, DNA and oligosaccharide chains in the entry. The first graphic for a chain summarises the proportions of the various outlier classes displayed in the second graphic. The second graphic shows the sequence view annotated by issues in geometry and electron density. Residues are color-coded according to the number of geometric quality criteria for which they contain at least one outlier: green = 0, yellow = 1, orange = 2 and red = 3 or more. A red dot above a residue indicates a poor fit to the electron density ($RSRZ > 2$). Stretches of 2 or more consecutive residues without any outlier are shown as a green connector. Residues present in the sample, but not in the model, are shown in grey.

- Molecule 1: Succinylglutamatedesuccinylase/aspartoacylase

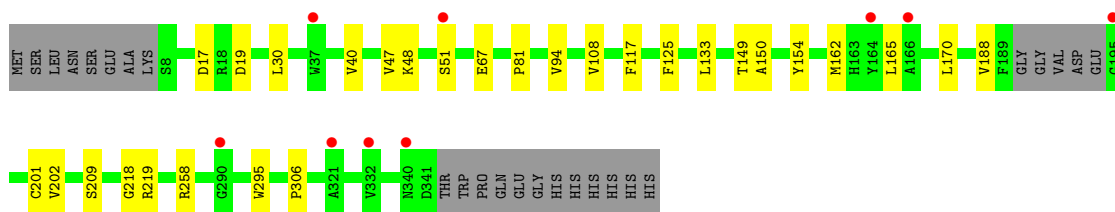
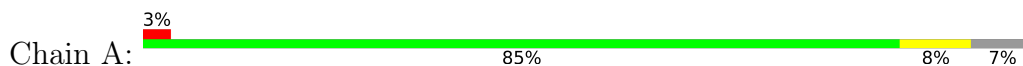

- Molecule 1: Succinylglutamatedesuccinylase/aspartoacylase

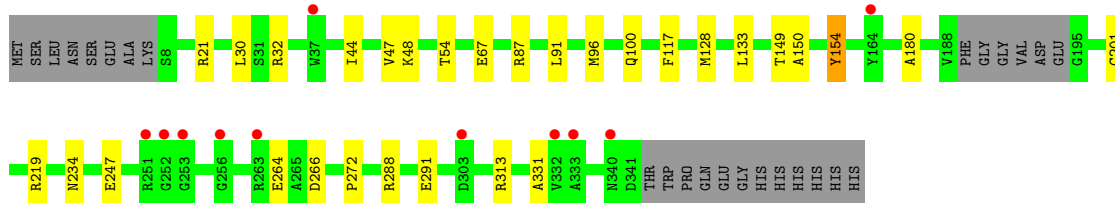
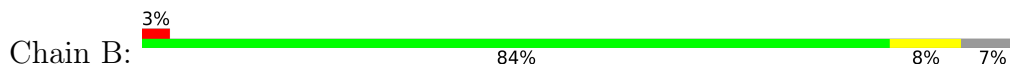

- Molecule 1: Succinylglutamatedesuccinylase/aspartoacylase

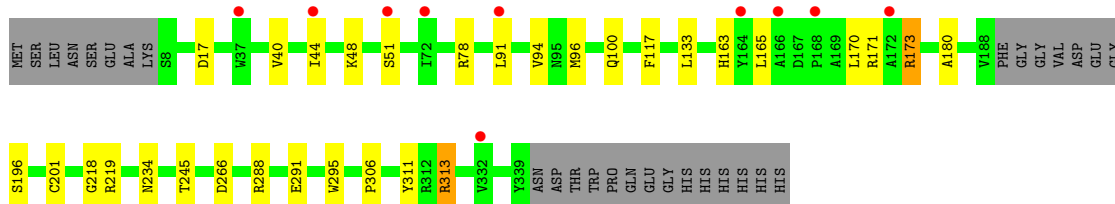
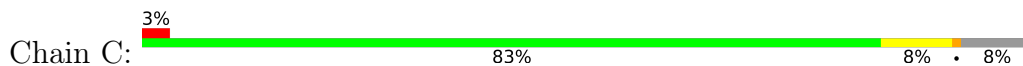

- Molecule 1: Succinylglutamatedesuccinylase/aspartoacylase

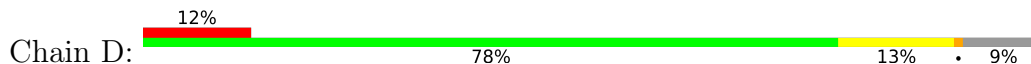

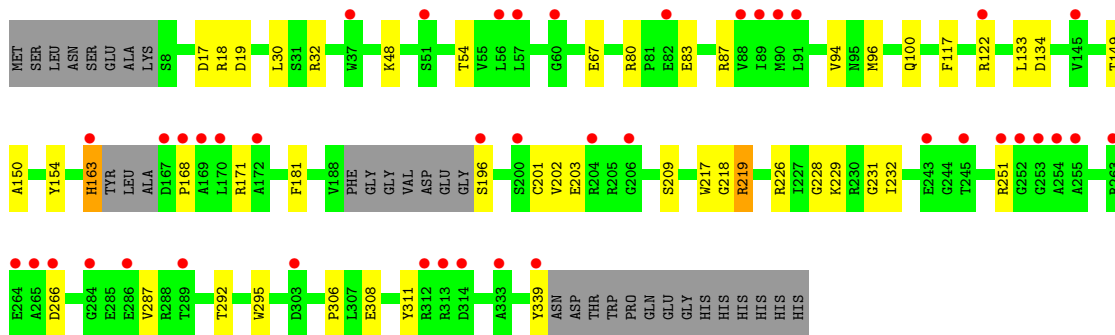

● Molecule 1: Succinylglutamatedesuccinylase/aspartoacylase

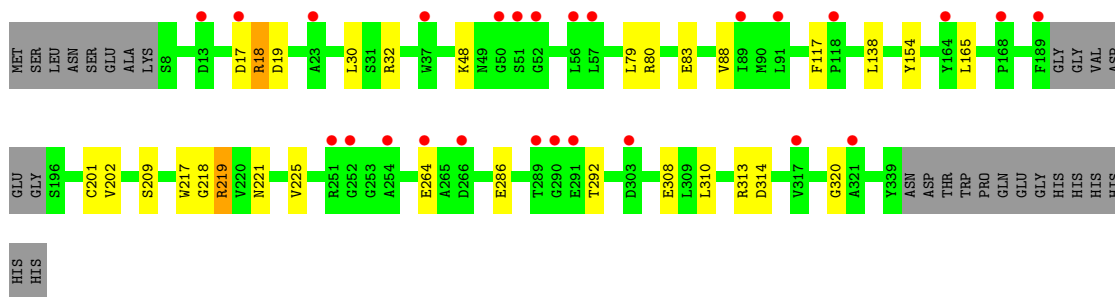
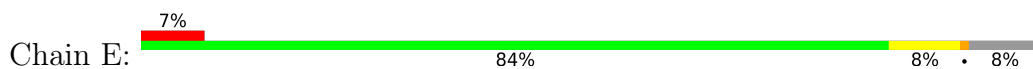

● Molecule 1: Succinylglutamatedesuccinylase/aspartoacylase

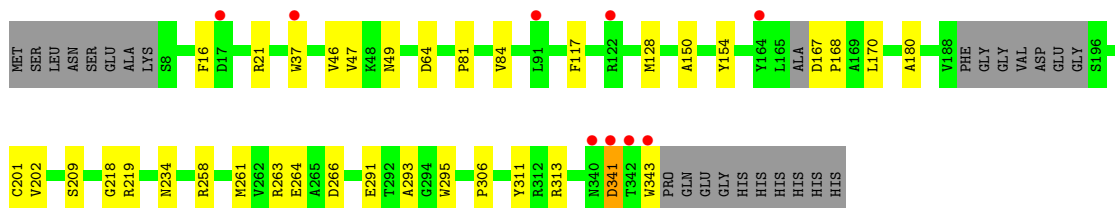
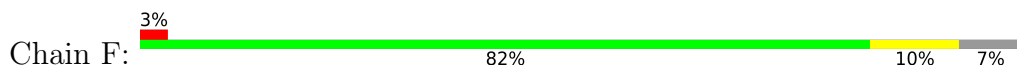

4 Data and refinement statistics

Property	Value	Source
Space group	P 21 21 2	Depositor
Cell constants a, b, c, α , β , γ	152.47Å 174.43Å 77.41Å 90.00° 90.00° 90.00°	Depositor
Resolution (Å)	20.00 – 2.10 22.81 – 2.10	Depositor EDS
% Data completeness (in resolution range)	95.2 (20.00-2.10) 95.2 (22.81-2.10)	Depositor EDS
R_{merge}	0.11	Depositor
R_{sym}	0.11	Depositor
$\langle I/\sigma(I) \rangle$ ¹	2.59 (at 2.09Å)	Xtrriage
Refinement program	REFMAC	Depositor
R, R_{free}	0.181 , 0.244 0.186 , 0.249	Depositor DCC
R_{free} test set	5820 reflections (5.06%)	wwPDB-VP
Wilson B-factor (Å ²)	26.2	Xtrriage
Anisotropy	0.442	Xtrriage
Bulk solvent k_{sol} (e/Å ³), B_{sol} (Å ²)	0.37 , 53.1	EDS
L-test for twinning ²	$\langle L \rangle = 0.47$, $\langle L^2 \rangle = 0.30$	Xtrriage
Estimated twinning fraction	No twinning to report.	Xtrriage
F_o, F_c correlation	0.94	EDS
Total number of atoms	16156	wwPDB-VP
Average B, all atoms (Å ²)	36.0	wwPDB-VP

Xtrriage's analysis on translational NCS is as follows: *The largest off-origin peak in the Patterson function is 5.20% of the height of the origin peak. No significant pseudotranslation is detected.*

¹Intensities estimated from amplitudes.

²Theoretical values of $\langle |L| \rangle$, $\langle L^2 \rangle$ for acentric reflections are 0.5, 0.333 respectively for untwinned datasets, and 0.375, 0.2 for perfectly twinned datasets.

5 Model quality [i](#)

5.1 Standard geometry [i](#)

Bond lengths and bond angles in the following residue types are not validated in this section:
CA

The Z score for a bond length (or angle) is the number of standard deviations the observed value is removed from the expected value. A bond length (or angle) with $|Z| > 5$ is considered an outlier worth inspection. RMSZ is the root-mean-square of all Z scores of the bond lengths (or angles).

Mol	Chain	Bond lengths		Bond angles	
		RMSZ	# Z >5	RMSZ	# Z >5
1	A	0.78	0/2553	0.77	0/3471
1	B	0.73	0/2568	0.74	0/3489
1	C	0.73	0/2541	0.76	0/3454
1	D	0.60	0/2486	0.68	0/3378
1	E	0.66	0/2529	0.72	0/3438
1	F	0.73	0/2584	0.76	1/3511 (0.0%)
All	All	0.71	0/15261	0.74	1/20741 (0.0%)

Chiral center outliers are detected by calculating the chiral volume of a chiral center and verifying if the center is modelled as a planar moiety or with the opposite hand. A planarity outlier is detected by checking planarity of atoms in a peptide group, atoms in a mainchain group or atoms of a sidechain that are expected to be planar.

Mol	Chain	#Chirality outliers	#Planarity outliers
1	B	0	1

There are no bond length outliers.

All (1) bond angle outliers are listed below:

Mol	Chain	Res	Type	Atoms	Z	Observed($^{\circ}$)	Ideal($^{\circ}$)
1	F	64	ASP	CB-CG-OD1	5.90	123.61	118.30

There are no chirality outliers.

All (1) planarity outliers are listed below:

Mol	Chain	Res	Type	Group
1	B	154	TYR	Peptide

5.2 Too-close contacts

In the following table, the Non-H and H(model) columns list the number of non-hydrogen atoms and hydrogen atoms in the chain respectively. The H(added) column lists the number of hydrogen atoms added and optimized by MolProbity. The Clashes column lists the number of clashes within the asymmetric unit, whereas Symm-Clashes lists symmetry-related clashes.

Mol	Chain	Non-H	H(model)	H(added)	Clashes	Symm-Clashes
1	A	2493	0	2420	18	0
1	B	2503	0	2445	15	0
1	C	2476	0	2417	17	0
1	D	2432	0	2361	30	0
1	E	2472	0	2400	19	0
1	F	2518	0	2461	28	0
2	A	1	0	0	0	0
2	B	1	0	0	0	0
2	C	1	0	0	0	0
2	D	1	0	0	0	0
2	E	1	0	0	0	0
2	F	1	0	0	0	0
3	A	243	0	0	2	0
3	B	244	0	0	2	0
3	C	210	0	0	2	0
3	D	152	0	0	5	0
3	E	174	0	0	2	0
3	F	233	0	0	3	0
All	All	16156	0	14504	121	0

The all-atom clashscore is defined as the number of clashes found per 1000 atoms (including hydrogen atoms). The all-atom clashscore for this structure is 4.

The worst 5 of 121 close contacts within the same asymmetric unit are listed below, sorted by their clash magnitude.

Atom-1	Atom-2	Interatomic distance (Å)	Clash overlap (Å)
1:F:261:MET:HE3	1:F:343:TRP:CZ2	1.97	1.00
1:E:264:GLU:HG3	1:E:313:ARG:HH12	1.42	0.84
1:F:266:ASP:HB3	1:F:313:ARG:HG3	1.61	0.82
1:E:154:TYR:HE2	1:F:37[B]:TRP:CE3	1.99	0.80
1:F:261:MET:CE	1:F:343:TRP:CZ2	2.64	0.80

There are no symmetry-related clashes.

5.3 Torsion angles [i](#)

5.3.1 Protein backbone [i](#)

In the following table, the Percentiles column shows the percent Ramachandran outliers of the chain as a percentile score with respect to all X-ray entries followed by that with respect to entries of similar resolution.

The Analysed column shows the number of residues for which the backbone conformation was analysed, and the total number of residues.

Mol	Chain	Analysed	Favoured	Allowed	Outliers	Percentiles	
1	A	327/354 (92%)	319 (98%)	8 (2%)	0	100	100
1	B	328/354 (93%)	320 (98%)	8 (2%)	0	100	100
1	C	325/354 (92%)	316 (97%)	9 (3%)	0	100	100
1	D	317/354 (90%)	305 (96%)	12 (4%)	0	100	100
1	E	323/354 (91%)	311 (96%)	12 (4%)	0	100	100
1	F	326/354 (92%)	318 (98%)	8 (2%)	0	100	100
All	All	1946/2124 (92%)	1889 (97%)	57 (3%)	0	100	100

There are no Ramachandran outliers to report.

5.3.2 Protein sidechains [i](#)

In the following table, the Percentiles column shows the percent sidechain outliers of the chain as a percentile score with respect to all X-ray entries followed by that with respect to entries of similar resolution.

The Analysed column shows the number of residues for which the sidechain conformation was analysed, and the total number of residues.

Mol	Chain	Analysed	Rotameric	Outliers	Percentiles	
1	A	258/281 (92%)	256 (99%)	2 (1%)	81	86
1	B	262/281 (93%)	256 (98%)	6 (2%)	50	55
1	C	257/281 (92%)	251 (98%)	6 (2%)	50	55
1	D	252/281 (90%)	245 (97%)	7 (3%)	43	47
1	E	256/281 (91%)	249 (97%)	7 (3%)	44	48
1	F	264/281 (94%)	259 (98%)	5 (2%)	57	63
All	All	1549/1686 (92%)	1516 (98%)	33 (2%)	52	59

5 of 33 residues with a non-rotameric sidechain are listed below:

Mol	Chain	Res	Type
1	D	18	ARG
1	D	163	HIS
1	F	264	GLU
1	D	30	LEU
1	D	80	ARG

Sometimes sidechains can be flipped to improve hydrogen bonding and reduce clashes. All (4) such sidechains are listed below:

Mol	Chain	Res	Type
1	C	100	GLN
1	C	281	HIS
1	D	163	HIS
1	E	100	GLN

5.3.3 RNA [i](#)

There are no RNA molecules in this entry.

5.4 Non-standard residues in protein, DNA, RNA chains [i](#)

There are no non-standard protein/DNA/RNA residues in this entry.

5.5 Carbohydrates [i](#)

There are no monosaccharides in this entry.

5.6 Ligand geometry [i](#)

Of 6 ligands modelled in this entry, 6 are monoatomic - leaving 0 for Mogul analysis.

There are no bond length outliers.

There are no bond angle outliers.

There are no chirality outliers.

There are no torsion outliers.

There are no ring outliers.

No monomer is involved in short contacts.

5.7 Other polymers [i](#)

There are no such residues in this entry.

5.8 Polymer linkage issues [i](#)

There are no chain breaks in this entry.

6 Fit of model and data [i](#)

6.1 Protein, DNA and RNA chains [i](#)

In the following table, the column labelled ‘#RSRZ> 2’ contains the number (and percentage) of RSRZ outliers, followed by percent RSRZ outliers for the chain as percentile scores relative to all X-ray entries and entries of similar resolution. The OWAB column contains the minimum, median, 95th percentile and maximum values of the occupancy-weighted average B-factor per residue. The column labelled ‘Q< 0.9’ lists the number of (and percentage) of residues with an average occupancy less than 0.9.

Mol	Chain	Analysed	<RSRZ>	#RSRZ>2	OWAB(Å ²)	Q<0.9
1	A	329/354 (92%)	0.03	9 (2%) 54 60	19, 29, 44, 53	0
1	B	328/354 (92%)	0.13	11 (3%) 45 51	22, 32, 44, 53	0
1	C	325/354 (91%)	0.08	10 (3%) 49 55	22, 32, 46, 61	0
1	D	322/354 (90%)	0.70	42 (13%) 3 4	28, 44, 61, 74	0
1	E	326/354 (92%)	0.53	26 (7%) 12 16	26, 39, 57, 61	0
1	F	328/354 (92%)	0.03	9 (2%) 54 60	21, 31, 45, 59	0
All	All	1958/2124 (92%)	0.25	107 (5%) 25 31	19, 34, 53, 74	0

The worst 5 of 107 RSRZ outliers are listed below:

Mol	Chain	Res	Type	RSRZ
1	E	164	TYR	6.1
1	D	168	PRO	5.7
1	D	169	ALA	5.0
1	D	265	ALA	4.9
1	E	51	SER	4.6

6.2 Non-standard residues in protein, DNA, RNA chains [i](#)

There are no non-standard protein/DNA/RNA residues in this entry.

6.3 Carbohydrates [i](#)

There are no monosaccharides in this entry.

6.4 Ligands [i](#)

In the following table, the Atoms column lists the number of modelled atoms in the group and the number defined in the chemical component dictionary. The B-factors column lists the minimum, median, 95th percentile and maximum values of B factors of atoms in the group. The column labelled 'Q< 0.9' lists the number of atoms with occupancy less than 0.9.

Mol	Type	Chain	Res	Atoms	RSCC	RSR	B-factors(Å ²)	Q<0.9
2	CA	E	401	1/1	0.94	0.10	52,52,52,52	0
2	CA	C	401	1/1	0.96	0.10	45,45,45,45	0
2	CA	D	401	1/1	0.96	0.12	65,65,65,65	0
2	CA	A	401	1/1	0.96	0.27	51,51,51,51	0
2	CA	F	401	1/1	0.98	0.10	48,48,48,48	0
2	CA	B	401	1/1	0.98	0.10	40,40,40,40	0

6.5 Other polymers [i](#)

There are no such residues in this entry.