

Network Working Group
Request for Comments: 4004
Category: Standards Track

P. Calhoun
Cisco Systems, Inc.
T. Johansson
Bytemobile Inc
C. Perkins
Nokia Research Center
T. Hiller, Ed.
P. McCann
Lucent Technologies
August 2005

Diameter Mobile IPv4 Application

Status of This Memo

This document specifies an Internet standards track protocol for the Internet community, and requests discussion and suggestions for improvements. Please refer to the current edition of the "Internet Official Protocol Standards" (STD 1) for the standardization state and status of this protocol. Distribution of this memo is unlimited.

Copyright Notice

Copyright (C) The Internet Society (2005).

Abstract

This document specifies a Diameter application that allows a Diameter server to authenticate, authorize and collect accounting information for Mobile IPv4 services rendered to a mobile node. Combined with the Inter-Realm capability of the base protocol, this application allows mobile nodes to receive service from foreign service providers. Diameter Accounting messages will be used by the foreign and home agents to transfer usage information to the Diameter servers.

Table of Contents

1.	Introduction.	3
1.1.	Entities and Relationships.	4
1.2.	Mobility Security Associations.	4
1.3.	Handoff	6
1.4.	Structure of the Document	7
2.	Acronyms.	7
3.	Scenarios and Message Flows	7
3.1.	Inter-Realm Mobile IPv4	8

3.2.	Allocation of Home Agent in Foreign Network13
3.3.	Co-located Mobile Node.16
3.4.	Key Distribution.18
4.	Diameter Protocol Considerations.20
4.1.	Diameter Session Management20
5.	Command-Code Values23
5.1.	AA-Mobile-Node-Request.23
5.2.	AA-Mobile-Node-Answer25
5.3.	Home-Agent-MIP-Request26
5.4.	Home-Agent-MIP-Answer27
6.	Result-Code AVP Values.27
6.1.	Transient Failures.28
6.2.	Permanent Failures.28
7.	Mandatory AVPs.28
7.1.	MIP-Reg-Request AVP29
7.2.	MIP-Reg-Reply AVP29
7.3.	MIP-Mobile-Node-Address AVP30
7.4.	MIP-Home-Agent-Address AVP.30
7.5.	MIP-Feature-Vector AVP.30
7.6.	MIP-MN-AAA-Auth AVP32
7.7.	MIP-FA-Challenge AVP33
7.8.	MIP-Filter-Rule AVP33
7.9.	MIP-Candidate-Home-Agent-Host33
7.10.	MIP-Originating-Foreign-AAA AVP33
7.11.	MIP-Home-Agent-Host AVP33
8.	Key Distribution34
8.1.	Authorization Lifetime vs. MIP Key Lifetime.34
8.2.	Nonce vs. Session Key.35
8.3.	Distributing the Mobile-Home Session Key35
8.4.	Distributing the Mobile-Foreign Session Key.36
8.5.	Distributing the Foreign-Home Session Key.37
9.	Key Distribution AVPs38
9.1.	MIP-FA-to-MN-MSA AVP.39
9.2.	MIP-FA-to-HA-MSA AVP.39
9.3.	MIP-HA-to-FA-MSA AVP.40
9.4.	MIP-HA-to-MN-MSA AVP.40
9.5.	MIP-MN-to-FA-MSA AVP.40
9.6.	MIP-MN-to-HA-MSA AVP.41
9.7.	MIP-Session-Key AVP41
9.8.	MIP-Algorithm-Type AVP.41
9.9.	MIP-Replay-Mode AVP42
9.10.	MIP-FA-to-MN-SPI AVP.42
9.11.	MIP-FA-to-HA-SPI AVP.42
9.12.	MIP-Nonce AVP.42
9.13.	MIP-MSA-Lifetime AVP42
9.14.	MIP-HA-to-FA-SPI AVP43
10.	Accounting AVPs43
10.1.	Accounting-Input-Octets AVP43

- 10.2. Accounting-Output-Octets AVP43
- 10.3. Acct-Session-Time AVP43
- 10.4. Accounting-Input-Packets AVP43
- 10.5. Accounting-Output-Packets AVP43
- 10.6. Event-Timestamp AVP44
- 11. AVP Occurrence Tables44
 - 11.1. Mobile IP Command AVP Table44
 - 11.2. Accounting AVP Table.46
- 12. IANA Considerations46
 - 12.1. Command Codes46
 - 12.2. AVP Codes46
 - 12.3. Result-Code AVP Values.46
 - 12.4. MIP-Feature-Vector AVP Values47
 - 12.5. MIP-Algorithm-Type AVP Values47
 - 12.6. MIP-Replay-Mode AVP Values.47
 - 12.7. Application Identifier47
- 13. Security Considerations47
- 14. References.49
 - 14.1. Normative References.49
 - 14.2. Informative References.50
- 15. Acknowledgements.51
- Authors' Addresses.51
- Full Copyright Statement.53

1. Introduction

Mobile IPv4 [MOBILEIP] allows a Mobile Node (MN) to change its point of attachment to the Internet while maintaining its fixed home address. Packets directed to the home address are intercepted by a Home Agent (HA), encapsulated in a tunnel, and forwarded to the MN at its current point of attachment. Optionally, a Foreign Agent (FA) may be deployed at this point of attachment, which can serve as the tunnel endpoint and may also provide access control for the visited network link. In this role, the FA has to authenticate each MN that may attach to it, whether the MN is from the same or a different administrative domain. The FA has to verify that the MN is authorized to attach and use resources in the foreign domain. Also, the FA must provide information to the home administrative domain about the resources used by the MN while it is attached in the foreign domain.

The Authentication, Authorization, and Accounting (AAA) requirements for Mobile IPv4 are described in detail in other documents [MIPREQ, CDMA2000]. This document specifies a Diameter application to meet these requirements. This application is not applicable to the Mobile IPv6 protocol.

Message formats (e.g., as in section 5.1) are specified as lists of Attribute-Value Pairs (AVPs) using the syntax as described in RFC 2234 [ABNF]. This includes the use of the "*" symbol to denote zero or more occurrences of an AVP.

Conventions Used in This Document

The key words "MUST", "MUST NOT", "REQUIRED", "SHALL", "SHALL NOT", "SHOULD", "SHOULD NOT", "RECOMMENDED", "MAY", and "OPTIONAL" in this document are to be interpreted as described in RFC 2119 [KEYWORDS].

1.1. Entities and Relationships

The Diameter Mobile IPv4 Application supports the HA and FA in providing Mobile IPv4 service to MNs. Both the HA and FA act as Diameter clients. The MNs interact with the HA and FA by using only Mobile IPv4 and therefore do not implement Diameter.

The FA, when present, is always assumed to exist in the visited administrative domain. The HA may be statically or dynamically allocated to the MN in the home administrative domain or may be dynamically allocated to the MN in a visited administrative domain. The home domain contains a home AAA server (AAA_H), and the visited domain contains a foreign AAA server (AAA_F). When the MN is "at home" (present on its home network), the AAA_H and AAA_F may be the same.

1.2. Mobility Security Associations

The base Mobile IPv4 protocol [MOBILEIP] assumes the existence of a Mobility Security Association (MSA) between the MN and HA (MN-HA MSA). The MN-HA MSA is used to authenticate, by using a keyed hash-style algorithm, the Mobile IP Registration Request that is sent from the MN to the HA. It is important to authenticate Registration Requests, as they inform the HA about the MN's current Care-of-Address, which is the destination for tunneled packets from the home network. Without authentication, malicious attackers would be able to redirect packets to anywhere on the Internet. The MSA comprises an agreement on a Security Parameters Index (SPI, a 32-bit number) that will be used to refer to the MSA, an algorithm that will be used to compute keyed hashes over messages, and a shared secret key. To enable authentication of a message, the sender appends a Mobile IP Authentication Extension that contains the SPI and the result of running the keyed hash over the entire previous contents of the message. The recipient checks the Authentication Extension by looking up the MSA based on the SPI, re-computing the keyed hash, and verifying that the result is equal to the contents of the received Authentication Extension.

The base Mobile IPv4 protocol also supports an optional MSA between the MN and FA (MN-FA MSA). If available, the MN-FA MSA is used by the FA to authenticate each Registration Request passing through it on the way to the HA. Although not critical to the operation of the base protocol, the MN-FA MSA is useful when the FA has to know the authenticity of a Registration Request; e.g., when it will be generating accounting records for a session. The MN-FA MSA may also be useful in future work related to handoff optimization.

Similarly, Mobile IPv4 supports an optional MSA between the FA and HA (FA-HA MSA). The FA-HA MSA is useful for authenticating messages between the FA and HA, such as when the HA seeks to inform the FA that it has revoked a Mobile IP registration.

Note that configuration of MSAs that involve FAs is substantially more difficult than configuring the one between the MN and HA, because the MN and HA are often in the same administrative domain and the MN will retain the same HA for long periods of time. In contrast, the MN is likely to encounter many FAs over time and may often find itself in foreign administrative domains.

The base Mobile IPv4 protocol assumes that MNs are identified by their static home IP addresses and that all MSAs are statically preconfigured. The Diameter Mobile IPv4 application, together with extensions [MIPNAI, MIPCHAL, MIPKEYS, AAANAI] to the base Mobile IPv4 protocol, allows an MN to be dynamically assigned a home address and/or home agent when it attaches to the Internet. This set of specifications also supports the dynamic configuration of the MN-HA, MN-FA, and FA-HA MSAs. The dynamic configuration of these relationships is important to support deployments in which the MN can attach to a visited network without having a pre-established relationship with it.

Initially, the MN is assumed to have a long-term AAA security association only with the AAAH. This security association is indexed by the MN's NAI, and, like the MSAs, comprises an agreement on a SPI, an algorithm, and a shared secret key. The MN enters a visited network and requests service from some FA by sending a Mobile IPv4 Registration Request. The FA contacts an AAAF in its own administrative domain to authenticate and authorize the request for service. The AAAF and AAAH may establish a Diameter session directly with each other, such as via a Diameter Redirect, or may pass messages via a network of Diameter proxies. Where the AAAF and AAAH route messages to each other through proxies, rather than a direct connection, transitive trust is assumed. MNs can include their Network Access Identifier (NAI) in a Mobile IPv4 Registration Request [MIPNAI], which serves in place of the home address to identify the MN. The NAI is used to route Diameter messages toward the correct

AAAAH. This use of the NAI is consistent with the roaming model defined by the ROAMOPS Working Group [EVALROAM, RFC2607].

The AAAH can authenticate the Registration Request with the use of the MN-AAA security association [MIPCHAL]. If authentication is successful, the AAAH then generates and distributes MSAs to the MN, HA, and FA. For each of the MSA pairs that involve the MN (i.e., MN-HA/HA-MN MSAs and MN-FA/FA-MN MSAs), the AAAH generates a nonce and then hashes it together with the MN-AAA shared key to derive the session key for the MSA pair. The nonces are sent to the HA that includes them in the Registration Reply, which enables the MN to derive the same keys [MIPKEYS]. At the same time, the AAAH must distribute the MN-HA/HA-MN MSAs and the FA-HA/HA-FA MSAs to the HA and must distribute the MN-FA/FA-MN MSAs and the FA-HA/HA-FA MSAs to the FA. These are sent in Diameter AVPs and must be independently secured by using IPSec or TLS between the AAAH and the FA and between the AAAH and the HA. See section 8 for more information on key derivation and distribution.

Note that MSAs in Mobile IP are unidirectional in that, for example, the MN-HA MSA (used to protect traffic from the MN to the HA) and the HA-MN MSA (used to protect traffic from the HA to the MN) can use different SPIs, algorithms, and shared secrets. This is true of the base Mobile IP protocol despite common existing practice during manual configuration of MSAs in which all parameters are set to the same value in both directions. This document supports the use of different SPIs in each direction; however, it only supports the distribution of a single session key for each pair of MSAs between two nodes. The security implications of this are discussed in section 13. This document sometimes names only one of the two unidirectional MSAs when referring to the distribution of the single shared secret and the pair of SPIs for the pair of MSAs between two entities.

1.3. Handoff

In addition to supporting the derivation and transport of the MN-HA, MN-FA, and FA-HA MSAs, this application also supports MIPv4 handoff. When an MN moves from one point of attachment to another, the MN can continue the same Mobile IPv4 session by using its existing HA and home address.

The MN accomplishes this by sending a Mobile IPv4 Registration Request from its new point of attachment. To enable a single set of accounting records to be maintained for the entire session, including handoffs, it is necessary to allow the AAAH to bind the new registration to the pre-existing session. To enable the Mobile IPv4 Registration Request to be routed to the same AAAH, the MN SHOULD

include the AAAH NAI [AAANAI] in such re-registrations. Also, to assist the AAAH in routing the messages to the MN's existing HA the mobile node SHOULD include the HA NAI [AAANAI] in such re-registrations. If the mobile node does not support the Mobile IPv4 AAA NAI extension [AAANAI], this functionality is not available.

1.4. Structure of the Document

The remainder of this document is structured as follows. Section 2 provides acronym definitions. Section 3 provides some examples and message flows illustrating both the Mobile IPv4 and Diameter messages that occur when a mobile node attaches to the Internet. Section 4 defines the relationship of this application to the Diameter Base Protocol. Section 5 defines the new command codes. Section 6 defines the new result codes used by this application. Section 7 defines the set of mandatory Attribute-Value-Pairs (AVPs). Section 8 gives an overview of the key distribution capability, and Section 9 defines the key distribution AVPs. Section 10 defines the accounting AVPs, and section 11 contains a listing of all AVPs and their occurrence in Diameter commands. Finally, sections 12 and 13 give IANA and security considerations, respectively.

2. Acronyms

AAAH	Authentication, Authorization, and Accounting Home
AAAF	Authentication, Authorization, and Accounting Foreign
AMA	AA-Mobile-Node-Answer
AMR	AA-Mobile-Node-Request
ASR	Abort-Session-Request
AVP	Attribute Value Pair
CoA	Care-of-Address
FA	Foreign Agent
FQDN	Fully Qualified Domain Name
HA	Home Agent
HAA	Home-Agent-MIP-Answer
HAR	Home-Agent-MIP-Request
MN	Mobile Node
MSA	Mobility Security Association
NAI	Network Access Identifier
RRQ	Registration Request
SPI	Security Parameters Index
STR	Session-Termination-Request

3. Scenarios and Message Flows

This section presents four scenarios illustrating Diameter Mobile IPv4 application and describes the operation of key distribution.

In this document, the role of the "attendant" [MIPREQ] is performed by either the FA (when it is present in a visited network) or the HA (for co-located mobile nodes not registering via an FA), and these terms will be used interchangeably in the following scenarios.

3.1. Inter-Realm Mobile IPv4

When a mobile node requests service by issuing a Registration Request to the foreign agent, the foreign agent creates the AA-Mobile-Node-Request (AMR) message, which includes the AVPs defined in section 7. The Home Address, Home Agent, Mobile Node NAI, and other important fields are extracted from the registration messages for possible inclusion as Diameter AVPs. The AMR message is then forwarded to the local Diameter server, known as the AAA-Foreign, or AAAF.

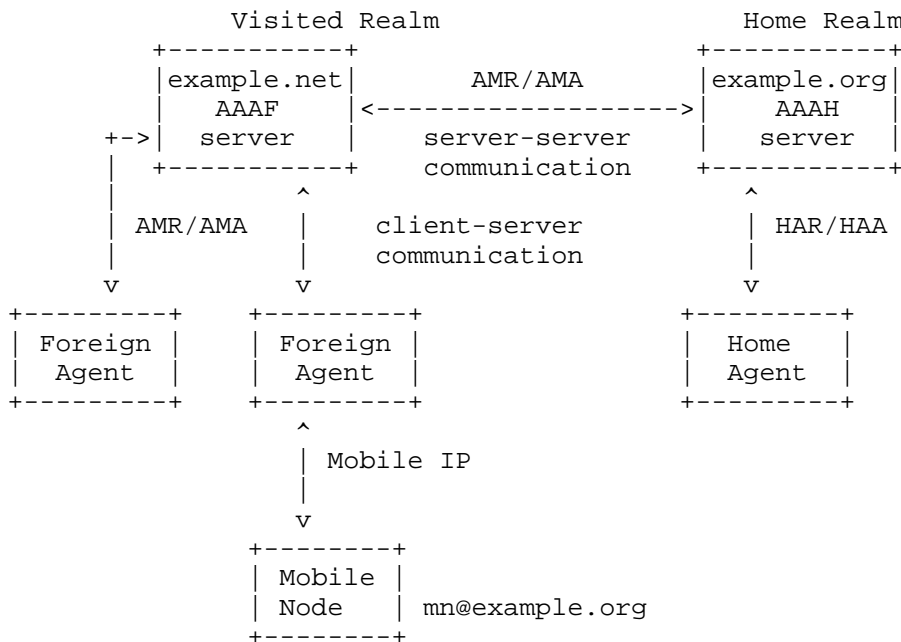

Figure 1. Inter-realm Mobility

Upon receiving the AMR, the AAAF follows the procedures outlined in [DIAMBASE] to determine whether the AMR should be processed locally or forwarded to another Diameter server known as the AAA-Home, or AAAH. Figure 1 shows an example in which a mobile node (mn@example.org) requests service from a foreign provider (example.net). The request received by the AAAF is forwarded to example.org's AAAH server.

Figure 2 shows the message flows involved when the foreign agent invokes the AAA infrastructure to request that a mobile node be authenticated and authorized. Note that it is not required that the foreign agent invoke AAA services every time a Registration Request is received from the mobile, but rather only when the prior authorization from the AAAH expires. The expiration time of the authorization is communicated through the Authorization-Lifetime AVP in the AA-Mobile-Node-Answer (AMA; see section 5.2) from the AAAH.

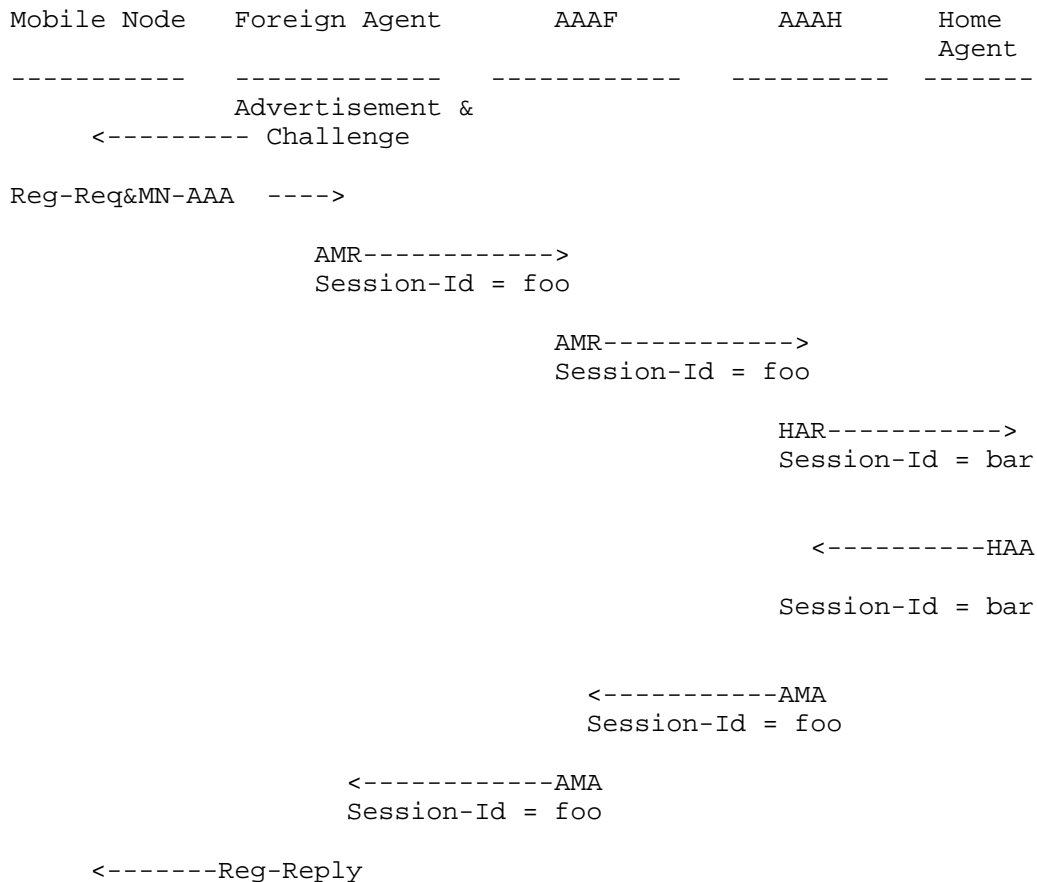

Figure 2. Mobile IPv4/Diameter Message Exchange

The foreign agent (as shown in Figure 2) MAY provide a challenge, which would give it direct control over the replay protection in the Mobile IPv4 registration process, as described in [MIPCHAL]. The mobile node includes the Challenge and MN-AAA authentication extension to enable authorization by the AAAH. If the authentication data supplied in the MN-AAA extension is invalid, the AAAH returns

the response (AMA) with the Result-Code AVP set to DIAMETER_AUTHENTICATION_REJECTED.

The above scenario causes the MN-FA and MN-HA keys to be exposed to Diameter agents all along the Diameter route. If this is a concern, a more secure approach is to eliminate the AAAF and other Diameter agents, as shown in Figure 3.

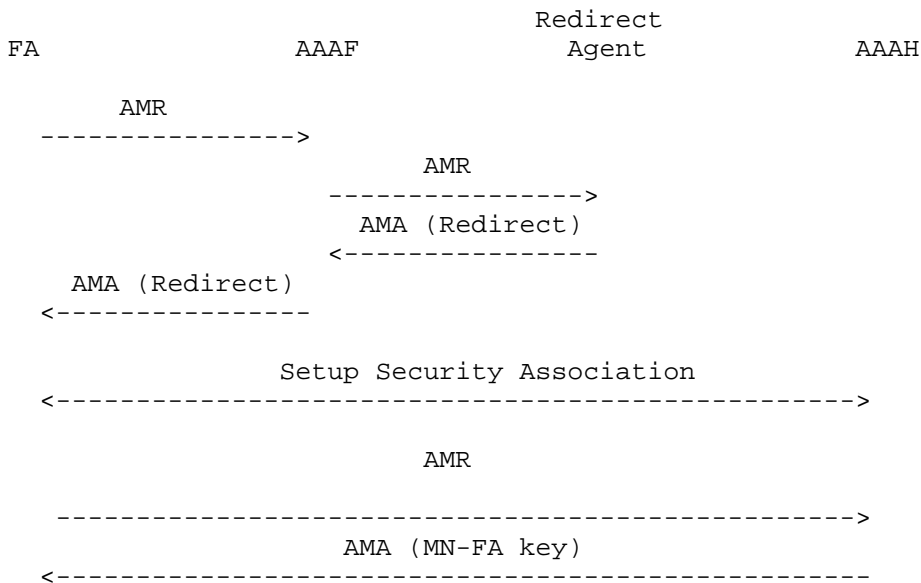

Figure 3. Use of a Redirect Server with AMR/AMA

In Figure 3, the FA sets up a TLS [TLS] or IPSec [IPSEC]-based security association with the AAAH directly and runs the AMR/AMA exchange over it. This provides end-to-end security for secret keys that may have to be distributed.

Figure 4 shows the interaction between the AAAH and HA with the help of a redirect agent. When the AAAH and HA are in the same network, it is likely that the AAAH knows the IP address of the HA, so the redirect server would therefore not be needed; however, it is shown anyway for completeness. The redirect server will most likely be used in the case where the HA is allocated in a foreign network (see section 3.2 for more details of HA allocation in foreign networks).

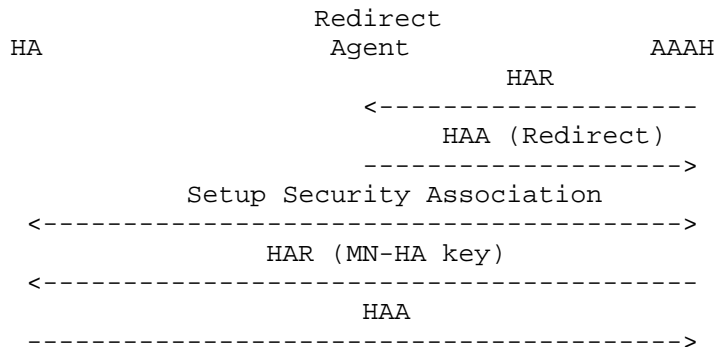

Figure 4. Use of a Redirect Server with HAR/HAA

As in Figure 2, the FA of Figure 3 would still provide the challenge and the mobile sends the RRQ, etc.; however, these steps were eliminated from Figure 3 to reduce clutter. The redirect server eliminates the AAAF and any other Diameter agents from seeing the keys as they are transported to the FA and HA. Note that the message flows in Figures 3 and 4 apply only to the initial authentication and key exchange. Accounting messages would still be sent via Diameter agents, not via the direct connection, unless network policies dictate otherwise.

A mobile node that supports the AAA NAI extension [AAANAI], which has been previously authenticated and authorized, MUST always include the assigned home agent in the HA Identity subtype of the AAA NAI extension, and the authorizing Home AAA server in the AAAH Identity subtype of the AAA NAI extension, when re-authenticating. Therefore, in the event that the AMR generated by the FA is for a session that was previously authorized, it MUST include the Destination-Host AVP, with the identity of the AAAH found in the AAAH-NAI, and the MIP-Home-Agent-Host AVP with the identity and realm of the assigned HA found in the HA-NAI. If, on the other hand, the mobile node does not support the AAA NAI extension, the FA may not have the identity of the AAAH and the identity and realm of the assigned HA. This means that without support of the AAA NAI extension, the FA may not be able to guarantee that the AMR will be destined to the same AAAH, which previously authenticated and authorized the mobile node, as the FA may not know the identity of the AAAH.

If the mobile node was successfully authenticated, the AAAH then determines which Home Agent to use for the session. First, the AAAH checks whether an HA has been requested by the MN by checking the MIP-Home-Agent-Address AVP and the MIP-Home-Agent-Host AVP. The administrative domain owning the HA may be determined from the realm portion of the MIP-Home-Agent-Host AVP, or by checking the

Home-Agent-In-Foreign-Network flag of the MIP-Feature-Vector AVP and the value of the MIP-Originating-Foreign-AAA AVP. If the requested HA belongs to a permitted administrative domain, the AAAH SHOULD use the given HA for the session. Otherwise, the AAAH returns the response (AMA) with the Result-Code AVP set to either `DIAMETER_ERROR_NO_FOREIGN_HA_SERVICE` or `DIAMETER_ERROR_HA_NOT_AVAILABLE`.

If the MN has not requested any particular HA, then an HA MUST be dynamically allocated. In this case the MIP-Feature-Vector will have the Home-Agent-Requested flag set. If the Home-Address-Allocatable-Only-in-Home-Realm flag is not set, and if the Foreign-Home-Agent-Available flag is set, then the AAAH SHOULD allow the foreign realm to allocate the HA (see section 3.2) but MAY allocate one itself in the home realm if dictated by local policy. If the Home-Address-Allocatable-Only-in-Home-Realm flag is set, then the AAAH MUST allocate an HA in the home realm on behalf of the MN. Allocation of the HA can be done in a variety of ways, including by using a load-balancing algorithm to keep the load on all home agents equal. The actual algorithm used and the method of discovering the home agents are outside the scope of this specification.

The AAAH then sends a Home-Agent-MIP-Request (HAR), which contains the Mobile IPv4 Registration Request message data encapsulated in the MIP-Reg-Request AVP, to the assigned or requested Home Agent. Refer to Figure 4 if the AAAH does not have a direct path to the HA. The AAAH MAY allocate a home address for the mobile node, and the Home Agent MUST support home address allocation. In the event that the AAAH handles address allocation, it includes the home address in a MIP-Mobile-Node-Address AVP within the HAR. The absence of this AVP informs the Home Agent that it must perform the home address allocation.

Upon receipt of the HAR, the home agent first processes the Diameter message. The home agent processes the MIP-Reg-Request AVP and creates the Registration Reply, encapsulating it within the MIP-Reg-Reply AVP. In the creation of the Registration Reply, the Home Agent MUST include the HA NAI and the AAAH NAI, which will be created from the Origin-Host AVP and Origin-Realm AVP of the HAR. If a home address is needed, the home agent MUST also assign one and include the address in both the Registration Reply and the MIP-Mobile-Node-Address AVP.

Upon receipt of the HAA, the AAAH creates the AA-Mobile-Node-Answer (AMA) message, which includes the same Acct-Multi-Session-Id contained in the HAA and the MIP-Home-Agent-Address and MIP-Mobile-

Node-Address AVPs in the AMA message. See Figures 3 and 4 for the use of the redirect agent for the secure transport of the HAA and AMA messages.

See section 4.1 for information on the management of sessions and session identifiers by the Diameter Mobile IPv4 entities.

3.2. Allocation of Home Agent in Foreign Network

The Diameter Mobile IPv4 application allows a home agent to be allocated in a foreign network, as required in [MIPREQ, CDMA2000]. When a foreign agent detects that the mobile node has a home agent address equal to 0.0.0.0 or 255.255.255.255 in the Registration Request message, it MUST add a MIP-Feature-Vector AVP with the Home-Agent-Requested flag set to one. If the home agent address is set to 255.255.255.255, the foreign agent MUST set the Home-Address-Allocatable-Only-in-Home-Realm flag equal to one. If the home agent address is set to 0.0.0.0, the foreign agent MUST set the Home-Address-Allocatable-Only-in-Home-Realm flag equal to zero.

When the AAAF receives an AMR message with the Home-Agent-Requested flag set to one and with the Home-Address-Allocatable-Only-in-Home-Realm flag equal to zero, the AAAF MAY set the Foreign-Home-Agent-Available flag in the MIP-Feature-Vector AVP in order to inform the AAAH that it is willing and able to assign a Home Agent for the mobile node. When doing so, the AAAF MUST include the MIP-Candidate-Home-Agent-Host AVP and the MIP-Originating-Foreign-AAA-AVP. The MIP-Candidate-Home-Agent-Host AVP contains the identity (i.e., a DiameterIdentity, which is an FQDN) of the home agent that would be assigned to the mobile node, and the MIP-Originating-Foreign-AAA AVP contains the identity of the AAAF. The AAAF now sends the AMR to the AAAH. However, as discussed above, the use of Diameter agents between the FA and AAAH would expose the MN-FA key. If this is deemed undesirable, a redirect server approach SHOULD be utilized to communicate the AMR to the AAAH. This causes the FA to communicate the AMR directly to the AAAH via a security association.

If the mobile node with AAA NAI extension support [AAANAI] has been previously authorized by the AAAH, now has to be re-authenticated, and requests to keep the assigned home agent in the foreign network, the mobile node MUST include the HA NAI and the AAAH NAI in the registration request to the FA. Upon receipt, the FA will create the AMR, including the MIP-Home-Agent-Address AVP and the Destination-Host AVP based on the AAAH NAI, and include the MIP-Home-Agent-Host AVP based on the home agent NAI. If the AAAF authorizes the use of the requested home agent, the AAAF MUST set the Home-Agent-In-Foreign-Network bit in the MIP-Feature-Vector AVP.

If the mobile node has to be re-authenticated but does not support the AAA NAI extension, it sends a registration request without the AAA NAI and the HA NAI, even though it has previously been authorized by the AAAH and requests to keep the assigned home agent in the foreign network. Upon receipt, the FA will create the AMR, including the MIP-Home-Agent-Address AVP. If the AAAF authorizes the use of the requested home agent, and if it knows that the agent is in its own domain, the AAAF MUST set the Home-Agent-In-Foreign-Network bit in the MIP-Feature-Vector AVP.

When the AAAH receives an AMR message, it first checks the authentication data supplied by the mobile node, according to the MIP-Reg-Request AVP and MIP-MN-AAA-Auth AVP, and determines whether to authorize the mobile node. If the AMR indicates that the AAAF has offered to allocate a Home Agent for the mobile node (i.e., the Foreign-Home-Agent-Available is set in the MIP-Feature-Vector AVP), or if the AMR indicates that the AAAF has offered a previously allocated Home Agent for the mobile node (i.e., the Home-Agent-In-Foreign-Network is set in the MIP-Feature-Vector AVP), then the AAAH must decide whether its local policy would allow the user to have or keep a home agent in the foreign network. Assuming that the mobile node is permitted to do so, the AAAH determines the IP address of the HA based upon the FQDN of the HA by using DNS or learns it via an MIP-Home-Agent-Address AVP in a redirect response to an HAR (i.e., if the redirect server adds this AVP to the HAA). Then it sends an HAR message to Home Agent by including the Destination-Host AVP set to the value found in the AMR's MIP-Candidate-Home-Agent-Host AVP or MIP-Home-Agent-Host AVP. If DNS is used to determine the HA IP address, it is assumed that the HA has a public address and that it can be resolved by DNS.

Security considerations may require that the HAR be sent directly from the AAAH to the HA without the use of intermediary Diameter agents. This requires that a security association between the AAAH and HA be established, as in Figure 4. If no security association can be established, the AAAH MUST return an AMA with the Result-Code AVP set to `DIAMETER_ERROR_END_TO_END_MIP_KEY_ENCRYPTION`.

If Diameter agents are being used (e.g., if there is no redirect server) the AAAH sends the HAR to the originating AAAF. In this HAR the Destination-Host AVP is set to the value found in the AMR's MIP-Originating-Foreign-AAA AVP, and the MIP-Home-Agent-Host AVP or the MIP-Candidate-Home-Agent-Host AVP found in the AMR is copied into the HAR.

Therefore, the AAAH MUST always copy the MIP-Originating-Foreign-AAA AVP from the AMR message to the HAR message. In cases when another AAAF receives the HAR, this new AAAF will send the HAR to the HA.

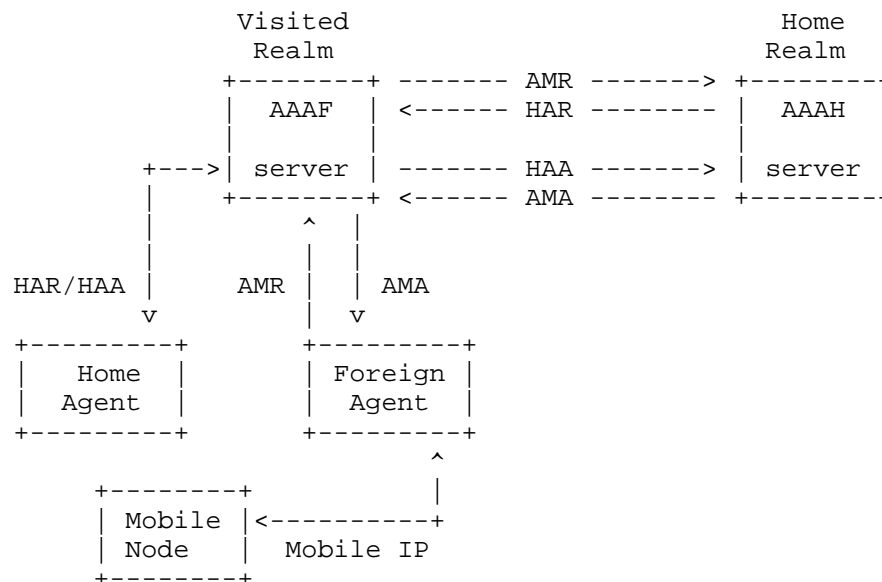

Figure 5. Home Agent Allocated in Visited Realm

Upon receipt of an HAA from the Home Agent in the visited realm, the AAAF forwards the HAA to the AAAH in the home realm. The AMA is then constructed and issued to the AAAF and, finally, to the FA. If the Result-Code indicates success, the HAA and AMA MUST include the MIP-Home-Agent-Address and the MIP-Mobile-Node-Address AVPs.

If exposing keys to the Diameter Agents along the way represents an unacceptable security risk, then the redirect approach depicted in Figures 3 and 4 MUST be used instead.

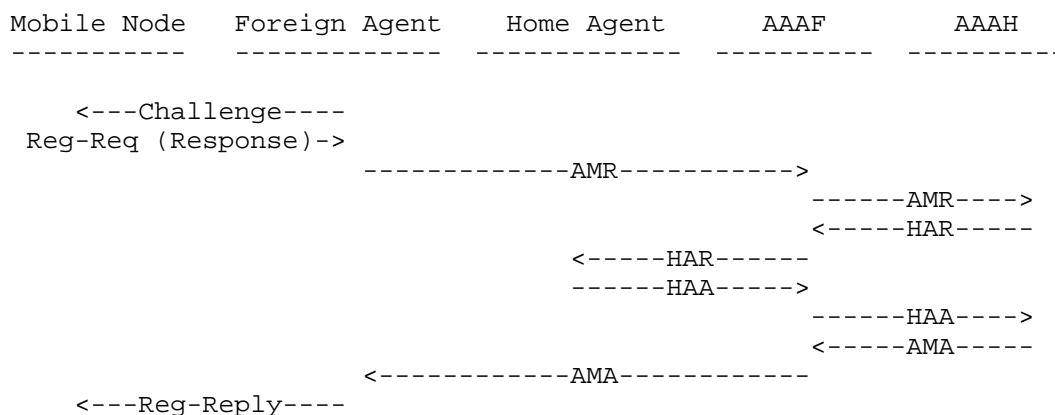

Figure 6. MIP/Diameter Exchange for HA Is Allocated in Visited Realm

If the mobile node moves to another foreign Network, it MAY either request to keep the same Home Agent within the old foreign network or request to get a new one in the new foreign network. If the AAAH is willing to provide the requested service, the AAAH will have to provide services for both visited networks; e.g., key refresh.

3.3. Co-located Mobile Node

If a mobile node registers with the Home Agent as a co-located mobile node, no foreign agent is involved. Therefore, when the Home Agent receives the Registration Request, an AMR message is sent to the local AAAH server, with the Co-Located-Mobile-Node bit set in the MIP-Feature-Vector AVP. The Home Agent also includes the Acct-Multi-Session-Id AVP (see sections 4.1.1 and 4.1.2) in the AMR sent to the AAAH, as the AAAH may find this piece of session-state or log entry information useful.

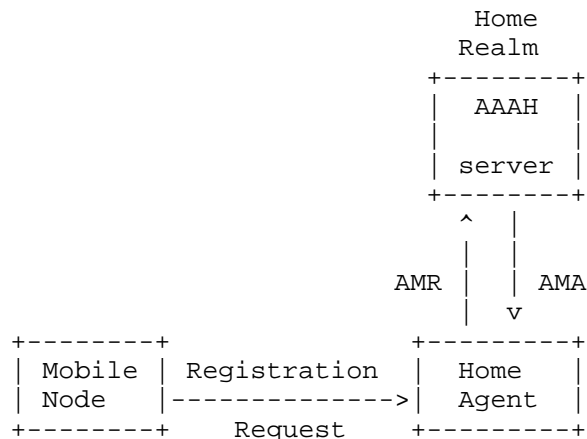

Figure 7. Co-located Mobile Node

If the MN-HA-Key-Requested bit was set in the AMR message from the Home Agent, the home agent and mobile node's session keys would be present in the AMA message.

Figure 8 shows a signaling diagram that indicates a secure way to set up the necessary security associations when using redirect servers. The Proxy AAA represents any AAA server or servers that the HA may use. This applies to the visited or home network.

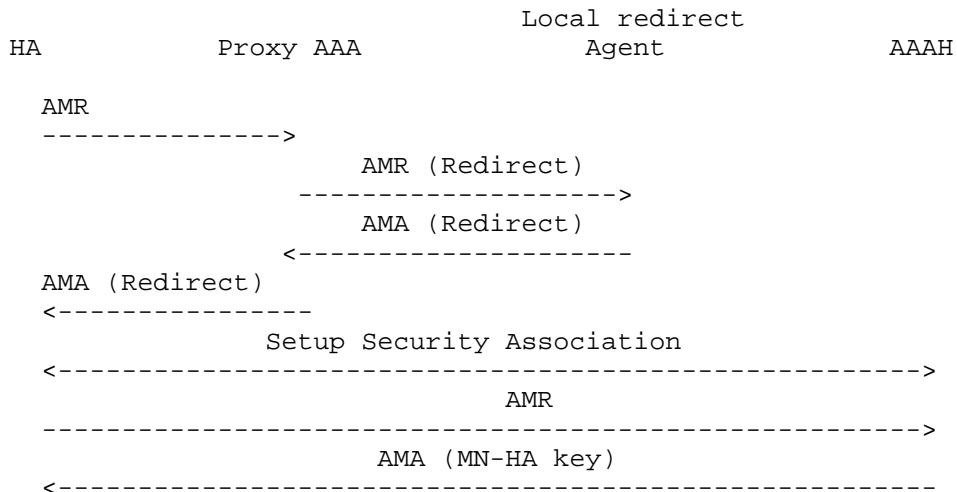

Figure 8. Use of Redirect Server for Co-located CoA and AMR/AMA

3.4. Key Distribution

To allow the scaling of wireless data access across administrative domains, it is necessary to minimize the number of pre-existing Mobility Security Associations (MSAs) required. This means that each Foreign Agent should not be required to have a pre-configured MSA with each Home Agent on the Internet, nor should the mobile node be required to have a pre-configured MSA (as defined in [MOBILEIP]) with any specific foreign agent. Furthermore, when the mobile node requests a dynamically allocated home agent, it is likely to receive the address of a home agent for which it has no available mobility security association.

The Diameter Mobile IPv4 application solves this by including key distribution functionality, which means that after a Mobile Node is authenticated the authorization phase includes the generation of session keys and nonces. Specifically, three session keys and two nonces are generated:

- K1: The MN-HA Session Key, which will be part of the MSA between the Mobile Node and the Home Agent. The MN-HA Session Key is derived from a nonce generated by AAA. The mobile node obtains that nonce in the Registration Reply and generates this key using the same formula that AAA uses.

- K2: The MN-FA Key, which will be part of the MSA between the Mobile Node and the Foreign Agent. The MN-FA Key is derived from a nonce generated by AAA. The mobile node obtains that nonce in the Registration Reply and generates the MN-FA key using the same formula that AAA uses.
- K3: The FA-HA Key, which will be part of the MSA between the Foreign Agent and the Home Agent.

The same session key is used in both directions between two entities; e.g., the Mobile Node and the Foreign Agent use the same session key for the MN-FA and the FA-MN authentication extensions. The security implications of this are examined in section 13. However, the SPIs may be different for the MN-FA and the FA-MN authentication extensions. The SPI for the MN-FA MSA is used on messages sent from the MN to the FA, and the SPI for the FA-MN MSA is used on messages sent from the FA to the MN.

All keys and nonces are generated by the AAAH, even if a Home Agent is dynamically allocated in the foreign network.

Figure 9 depicts the MSAs used for Mobile-IPv4 message integrity using the keys created by the DIAMETER server.

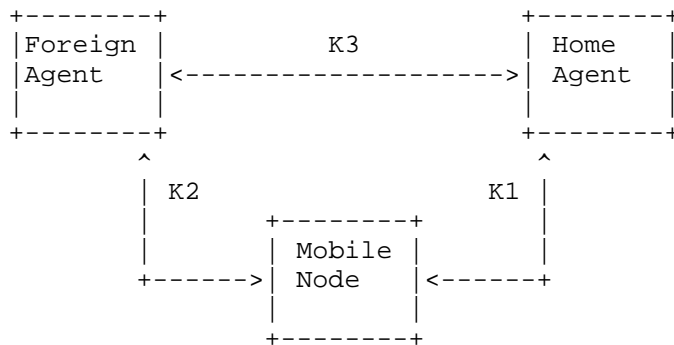

Figure 9. Mobility Security Associations after Session Key and Nonce Distribution

The keys destined for the foreign and home agent are propagated to the mobility agents via the Diameter protocol. If exposing keys to the Diameter Agents along the way represents an unacceptable security risk, then the keys MUST be protected either by IPSec or TLS security associations that exist directly between the HA and AAAH or the FA and AAAF, as explained above.

The keys destined for the mobile node MUST also be propagated via the Mobile IPv4 protocol and therefore MUST follow the mechanisms described in [MIPKEYS] instead. In [MIPKEYS], the mobile node receives a nonce for each key it needs, and the mobile node will use the nonce and the long-term shared secret to create the keys (see section 8).

Once the session keys have been established and propagated, the mobility devices can exchange registration information directly, as defined in [MOBILEIP], without the need of the Diameter infrastructure. However, the session keys have a lifetime, after which the Diameter infrastructure MUST be invoked again if new session keys and nonces are to be acquired.

4. Diameter Protocol Considerations

This section details the relationship of the Diameter Mobile IPv4 application to the Diameter base protocol.

This document specifies Diameter Application-ID 2. Diameter nodes conforming to this specification MAY advertise support by including the value of two (2) in the Auth-Application-Id or the Acct-Application-Id AVP of the Capabilities-Exchange-Request and Capabilities-Exchange-Answer commands [DIAMBASE]. The value of two (2) MUST be used as the Application-Id in all AMR/AMA and HAR/HAA commands. The value of two (2) MUST be used as the Application-Id in all ACR/ACA commands, as this application defines new, mandatory AVPs for accounting. The value of zero (0) SHOULD be used as the Application-Id in all STR/STA and ASR/ASA commands, as these are defined in the Diameter base protocol and no additional mandatory AVPs for those commands are defined in this document.

Given the nature of Mobile IPv4, re-authentication can only be initiated by a mobile node, which does not participate in the Diameter message exchanges. Therefore, Diameter server initiated re-auth does not apply to this application, and RAR/RAA commands MUST NOT be sent for Diameter Mobile IPv4 sessions.

4.1. Diameter Session Management

The AAAH and AAAF MAY maintain session-state or MAY be session-stateless. AAA redirect agents and AAA relay agents MUST NOT maintain session-state. The AAAH, AAAF, proxies and relays agents MUST maintain transaction state.

A mobile node's session is identified via its identity in the User-Name AVP and the MIP-Mobile-Node-Address, and the MIP-Home-Agent-Address AVPs. This is necessary in order to allow the session state

machine, defined in the base protocol [DIAMBASE], to be used without modification for this application. However, as the MN may interact with more than one FA during the life of its session, it is important for the Diameter Mobile IPv4 application to distinguish the two pieces of the session (some state at the FA, some state at the HA) and to manage them independently. The following sub-sections give further details.

4.1.1. Session Identifiers

During creation of the AMR, the FA will choose a session identifier. During the creation of the HAR, the AAAH MUST use a different session identifier than that used in the AMR/AMA. If the AAAH is session-stateful, it MUST send the same session identifier for all HARs initiated on behalf of a given mobile node's session. Otherwise, if the AAAH is session-stateless, it will manufacture a unique session-id for every HAR.

When the HA is first allocated, it MUST create and include an Acct-Multi-Session-Id AVP in the HAA returned to the AAAH. This identifier will be kept constant for the life of the Mobile IPv4 session, as detailed in the next subsection.

4.1.2. Managing Sessions during Mobile IPv4 Handoffs

Given the nature of Mobile IPv4, a mobile node MAY receive service from many foreign agents during a period of time. However, the home realm should not view these handoffs as different sessions, as this could affect billing systems. Furthermore, foreign agents usually do not communicate between each other, which implies that AAA information cannot be exchanged between these entities.

A handoff registration request from a mobile node will cause the FA to send an AMR to its AAAF. The AMR will include a new session identifier and MAY be sent to a new AAAF (i.e., a AAAF different from that used by the previous FA). However, the AMR shall be received by the AAAH to which the user is currently registered (possibly via the redirect mechanism depicted in Figure 3).

As the AAAH may be session-stateless, it is necessary for the resulting HAR received by the HA to be identified as a continuation of an existing session. If the HA receives an HAR for a mobile node with a new session identifier and the HA can guarantee that this request is to extend an existing service, then the HA MUST be able to modify its internal session state information to reflect the new session identifier.

For correlation to occur, accounting records must have some commonality across handoffs. Therefore, the home agent MUST send the same Acct-Multi-Session-Id AVP value in all HAAs for the mobile's session. That is, the HA generates a unique Acct-Multi-Session-Id when receiving an HAR for a new session and returns this same value in every HAA for the session. This Acct-Multi-Session-Id AVP will be returned to the foreign agent by the AAAH in the AMA. Both the foreign and home agents MUST include the Acct-Multi-Session-Id in the accounting messages, as depicted in Figure 10.

4.1.3. Diameter Session Termination

A foreign and home agent following this specification MAY expect their respective Diameter servers to maintain session state information for each mobile node in their networks. For a Diameter Server to release any resources allocated to a specific mobile node, that server has to receive a Session-Termination-Request (STR) from a mobility agent. The mobility agents MUST issue the Session-Termination-Request (STR) if the Authorization Lifetime has expired and no subsequent MIP registration request has been received.

The AAAH SHOULD only deallocate all resources after the STR is received from the home agent. This ensures that a mobile node that moves from one foreign agent to another (for example, as a result of a handover) does not cause the Home Diameter Server to free all resources for the mobile node. Therefore, an STR from a foreign agent would free the session from the foreign agent, but not the session state associated with the home agent (see Figure 10).

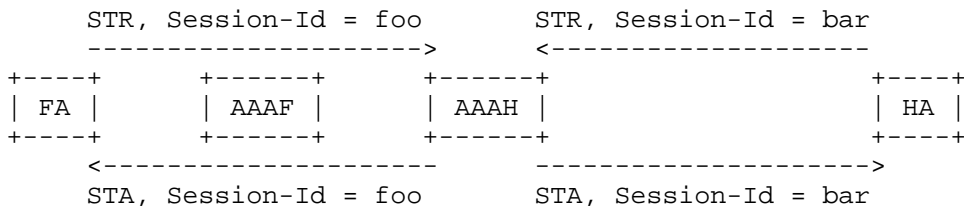

Figure 10. Session Termination and Session Identifiers

When deallocating all of the mobile node's resources, the home Diameter server (and the foreign Diameter server in the case of an HA allocated in foreign network) MUST destroy all session keys that may still be valid.

In the event that the AAAF wishes to terminate a session, its Abort-Session-Request (ASR) [DIAMBASE] message SHOULD be sent to the FA. Similarly, the AAAH SHOULD send its message to the Home Agent.

5. Command-Code Values

This section defines Command-Code [DIAMBASE] values that MUST be supported by all Diameter implementations conforming to this specification. The following Command Codes are defined in this specification:

Command-Name	Abbreviation	Code	Section
AA-Mobile-Node-Request	AMR	260	5.1
AA-Mobile-Node-Answer	AMA	260	5.2
Home-Agent-MIP-Request	HAR	262	5.3
Home-Agent-MIP-Answer	HAA	262	5.4

5.1. AA-Mobile-Node-Request

The AA-Mobile-Node-Request (AMR), indicated by the Command-Code field set to 260 and the 'R' bit set in the Command Flags field, is sent by an attendant (i.e., the Foreign Agent), acting as a Diameter client, to an AAAF in order to request the authentication and authorization of a mobile node. The foreign agent (or home agent in the case of a co-located Mobile Node) uses information found in the Registration Request to construct the following AVPs, to be included as part of the AMR:

- Home Address (MIP-Mobile-Node-Address AVP)
- Home Agent Address (MIP-Home-Agent-Address AVP)
- Mobile Node NAI (User-Name AVP [DIAMBASE])
- MN-HA Key Request (MIP-Feature-Vector AVP)
- MN-FA Key Request (MIP-Feature-Vector AVP)
- MN-AAA Authentication Extension (MIP-MN-AAA-Auth AVP)
- Foreign Agent Challenge Extension (MIP-FA-Challenge AVP)
- Home Agent NAI (MIP-Home-Agent-Host AVP)
- Home AAA server NAI (Destination-Host AVP [DIAMBASE])
- Home Agent to Foreign Agent SPI (MIP-HA-to-FA-SPI AVP)

If the mobile node's home address is zero, the foreign or home agent MUST NOT include a MIP-Mobile-Node-Address AVP in the AMR. If the home agent address is zero or all ones, the MIP-Home-Agent-Address AVP MUST NOT be present in the AMR.

If a home agent is used in a visited network, the AAAF MAY set the Foreign-Home-Agent-Available flag in the MIP-Feature-Vector AVP in the AMR message to indicate that it is willing to assign a Home Agent in the visited realm.

If the mobile node's home address is all ones, the foreign or home agent MUST include a MIP-Mobile-Node-Address AVP, set to all ones.

If the mobile node includes the home agent NAI and the home AAA server NAI [AAANAI], the foreign agent MUST include the MIP-Home-Agent-Host AVP and the Destination-Host AVP in the AMR.

Message Format

```
<AA-Mobile-Node-Request> ::= < Diameter Header: 260, REQ, PXY >
< Session-ID >
{ Auth-Application-Id }
{ User-Name }
{ Destination-Realm }
{ Origin-Host }
{ Origin-Realm }
{ MIP-Reg-Request }
{ MIP-MN-AAA-Auth }
[ Acct-Multi-Session-Id ]
[ Destination-Host ]
[ Origin-State-Id ]
[ MIP-Mobile-Node-Address ]
[ MIP-Home-Agent-Address ]
[ MIP-Feature-Vector ]
[ MIP-Originating-Foreign-AAA ]
[ Authorization-Lifetime ]
[ Auth-Session-State ]
[ MIP-FA-Challenge ]
[ MIP-Candidate-Home-Agent-Host ]
[ MIP-Home-Agent-Host ]
[ MIP-HA-to-FA-SPI ]
* [ Proxy-Info ]
* [ Route-Record ]
* [ AVP ]
```

5.2. AA-Mobile-Node-Answer

The AA-Mobile-Node-Answer (AMA), indicated by the Command-Code field set to 260 and the 'R' bit cleared in the Command Flags field, is sent by the AAAH in response to the AA-Mobile-Node-Request message. The User-Name MAY be included in the AMA if it is present in the AMR. The Result-Code AVP MAY contain one of the values defined in section 6, in addition to the values defined in [DIAMBASE].

An AMA message with the Result-Code AVP set to DIAMETER_SUCCESS MUST include the MIP-Home-Agent-Address AVP, MUST include the MIP-Mobile-Node-Address AVP, and includes the MIP-Reg-Reply AVP if and only if the Co-Located-Mobile-Node bit was not set in the MIP-Feature-Vector AVP. The MIP-Home-Agent-Address AVP contains the Home Agent assigned to the mobile node, while the MIP-Mobile-Node-Address AVP contains the home address that was assigned. The AMA message MUST contain the MIP-FA-to-HA-MSA and MIP-FA-to-MN-MSA if they were requested in the AMR and were present in the HAR. The MIP-MN-to-HA-MSA and MIP-HA-to-MN-MSA AVPs MUST be present if the session keys were requested in the AMR and the Co-Located-Mobile-Node bit was set in the MIP-Feature-Vector AVP.

Message Format

```

<AA-Mobile-Node-Answer> ::= < Diameter Header: 260, PXY >
                               < Session-Id >
                               { Auth-Application-Id }
                               { Result-Code }
                               { Origin-Host }
                               { Origin-Realm }
                               [ Acct-Multi-Session-Id ]
                               [ User-Name ]
                               [ Authorization-Lifetime ]
                               [ Auth-Session-State ]
                               [ Error-Message ]
                               [ Error-Reporting-Host ]
                               [ Re-Auth-Request-Type ]
                               [ MIP-Feature-Vector ]
                               [ MIP-Reg-Reply ]
                               [ MIP-MN-to-FA-MSA ]
                               [ MIP-MN-to-HA-MSA ]
                               [ MIP-FA-to-MN-MSA ]
                               [ MIP-FA-to-HA-MSA ]
                               [ MIP-HA-to-MN-MSA ]
                               [ MIP-MSA-Lifetime ]
                               [ MIP-Home-Agent-Address ]
                               [ MIP-Mobile-Node-Address ]
                               * [ MIP-Filter-Rule ]

```

```

    [ Origin-State-Id ]
    * [ Proxy-Info ]
    * [ AVP ]

```

5.3. Home-Agent-MIP-Request

The AAA sends the Home-Agent-MIP-Request (HAR), indicated by the Command-Code field set to 262 and the 'R' bit set in the Command Flags field, to the Home Agent. If the Home Agent is to be assigned in a foreign network, the HAR is issued by the AAAH and forwarded by the AAAF to the HA if no redirect servers are involved. If any are, the HAR is sent directly to the HA via a security association. If the HAR message does not include a MIP-Mobile-Node-Address AVP, the Registration Request has 0.0.0.0 for the home address, and the HAR is successfully processed, the Home Agent MUST allocate the mobile nodes address. If, on the other hand, the home agent's local AAA server allocates the mobile node's home address, the local AAA server MUST include the assigned address in a MIP-Mobile-Node-Address AVP.

When session keys are requested for use by the mobile node, the AAAH MUST create them and include them in the HAR message. When a FA-HA session key is requested, it will be created and distributed by the AAAH server.

Message Format

```

<Home-Agent-MIP-Request> ::= < Diameter Header: 262, REQ, PXY >
    < Session-Id >
    { Auth-Application-Id }
    { Authorization-Lifetime }
    { Auth-Session-State }
    { MIP-Reg-Request }
    { Origin-Host }
    { Origin-Realm }
    { User-Name }
    { Destination-Realm }
    { MIP-Feature-Vector }
    [ Destination-Host ]
    [ MIP-MN-to-HA-MSA ]
    [ MIP-MN-to-FA-MSA ]
    [ MIP-HA-to-MN-MSA ]
    [ MIP-HA-to-FA-MSA ]
    [ MIP-MSA-Lifetime ]
    [ MIP-Originating-Foreign-AAA ]
    [ MIP-Mobile-Node-Address ]
    [ MIP-Home-Agent-Address ]
    * [ MIP-Filter-Rule ]
    [ Origin-State-Id ]

```

```

* [ Proxy-Info ]
* [ Route-Record ]
* [ AVP ]

```

5.4. Home-Agent-MIP-Answer

In response to a Home-Agent-MIP-Request, the Home Agent sends the Home-Agent-MIP-Answer (HAA), indicated by the Command-Code field set to 262 and the 'R' bit cleared in the Command Flags field, to its local AAA server. The User-Name MAY be included in the HAA if it is present in the HAR. If the home agent allocated a home address for the mobile node, the address MUST be included in the MIP-Mobile-Node-Address AVP. The Result-Code AVP MAY contain one of the values defined in section 6 instead of the values defined in [DIAMBASE].

Message Format

```

<Home-Agent-MIP-Answer> ::= < Diameter Header: 262, PXY >
    < Session-Id >
    { Auth-Application-Id }
    { Result-Code }
    { Origin-Host }
    { Origin-Realm }
    [ Acct-Multi-Session-Id ]
    [ User-Name ]
    [ Error-Reporting-Host ]
    [ Error-Message ]
    [ MIP-Reg-Reply ]
    [ MIP-Home-Agent-Address ]
    [ MIP-Mobile-Node-Address ]
    [ MIP-FA-to-HA-SPI ]
    [ MIP-FA-to-MN-SPI ]
    [ Origin-State-Id ]
    * [ Proxy-Info ]
    * [ AVP ]

```

6. Result-Code AVP Values

This section defines new Result-Code [DIAMBASE] values that MUST be supported by all Diameter implementations that conform to this specification.

6.1. Transient Failures

Errors in the transient failures category are used to inform a peer that the request could not be satisfied at the time it was received, but that it may be able to satisfy the request in the future.

DIAMETER_ERROR_MIP_REPLY_FAILURE 4005
This error code is used by the home agent when processing of the Registration Request has failed.

DIAMETER_ERROR_HA_NOT_AVAILABLE 4006
This error code is used to inform the foreign agent that the requested Home Agent cannot be assigned to the mobile node at this time. The foreign agent MUST return a Mobile IPv4 Registration Reply to the mobile node with an appropriate error code.

DIAMETER_ERROR_BAD_KEY 4007
This error code is used by the home agent to indicate to the local Diameter server that the key generated is invalid.

DIAMETER_ERROR_MIP_FILTER_NOT_SUPPORTED 4008
This error code is used by a mobility agent to indicate to the home Diameter server that the requested packet filter Rules cannot be supported.

6.2. Permanent Failures

Errors that fall within the permanent failures category are used to inform the peer that the request failed and SHOULD NOT be attempted again.

DIAMETER_ERROR_NO_FOREIGN_HA_SERVICE 5024
This error is used by the AAAF to inform the AAAH that allocation of a home agent in the foreign domain is not permitted at this time.

DIAMETER_ERROR_END_TO_END_MIP_KEY_ENCRYPTION 5025
This error is used by the AAAF/AAAH to inform the peer that the requested Mobile IPv4 session keys could not be delivered via a security association.

7. Mandatory AVPs

The following table describes the Diameter AVPs defined in the Mobile IPv4 application; their AVP Code values, types, and possible flag values; and whether the AVP MAY be encrypted.

Due to space constraints, the short form IPFiltrRule is used to represent IPFilterRule, and DiamIdent is used to represent DiameterIdentity.

Attribute Name	AVP Code	Section Defined	Value Type	AVP Flag rules				
				MUST	MAY	SHLD NOT	MUST NOT	MAY Encr
MIP-Reg-Request	320	7.1	OctetString	M	P		V	Y
MIP-Reg-Reply	321	7.2	OctetString	M	P		V	Y
MIP-MN-AAA-Auth	322	7.6	Grouped	M	P		V	Y
MIP-Mobile-Node-Address	333	7.3	Address	M	P		V	Y
MIP-Home-Agent-Address	334	7.4	Address	M	P		V	Y
MIP-Candidate-Home-Agent-Host	336	7.9	DiamIdent	M	P		V	N
MIP-Feature-Vector	337	7.5	Unsigned32	M	P		V	Y
MIP-Auth-Input-Data-Length	338	7.6.2	Unsigned32	M	P		V	Y
MIP-Authenticator-Length	339	7.6.3	Unsigned32	M	P		V	Y
MIP-Authenticator-Offset	340	7.6.4	Unsigned32	M	P		V	Y
MIP-MN-AAA-SPI	341	7.6.1	Unsigned32	M	P		V	Y
MIP-Filter-Rule	342	7.8	IPFiltrRule	M	P		V	Y
MIP-FA-Challenge	344	7.7	OctetString	M	P		V	Y
MIP-Originating-Foreign-AAA	347	7.10	Grouped	M	P		V	Y
MIP-Home-Agent-Host	348	7.11	DiamIdent	M	P		V	N

7.1. MIP-Reg-Request AVP

The MIP-Reg-Request AVP (AVP Code 320) is of type OctetString and contains the Mobile IPv4 Registration Request [MOBILEIP] sent by the mobile node to the foreign agent.

7.2. MIP-Reg-Reply AVP

The MIP-Reg-Reply AVP (AVP Code 321) is of type OctetString and contains the Mobile IPv4 Registration Reply [MOBILEIP] sent by the home agent to the foreign agent.

7.3. MIP-Mobile-Node-Address AVP

The MIP-Mobile-Node-Address AVP (AVP Code 333) is of type Address and contains the mobile node's home IP address.

7.4. MIP-Home-Agent-Address AVP

The MIP-Home-Agent-Address AVP (AVP Code 334) is of type Address and contains the mobile node's home agent IP address.

7.5. MIP-Feature-Vector AVP

The MIP-Feature-Vector AVP (AVP Code 337) is of type Unsigned32 and is added with flag values set by the foreign agent or by the AAAF owned by the same administrative domain as the foreign agent. The foreign agent SHOULD include MIP-Feature-Vector AVP within the AMR message it sends to the AAAF.

Flag values currently defined include the following:

- 1 Mobile-Node-Home-Address-Requested
- 2 Home-Address-Allocatable-Only-in-Home-Realm
- 4 Home-Agent-Requested
- 8 Foreign-Home-Agent-Available
- 16 MN-HA-Key-Request
- 32 MN-FA-Key-Request
- 64 FA-HA-Key-Request
- 128 Home-Agent-In-Foreign-Network
- 256 Co-Located-Mobile-Node

The flags are set according to the following rules.

If the mobile node includes a valid home address (i.e., one not equal to 0.0.0.0 or 255.255.255.255) in its Registration Request, the foreign agent sets the Mobile-Node-Home-Address-Requested flag in the MIP-Feature-Vector AVP to zero.

If the mobile node sets the home agent field equal to 255.255.255.255 in its Registration Request, the foreign agent sets both the Home-Agent-Requested flag and the Home-Address-Allocatable-Only-in-Home-Realm flag to one in the MIP-Feature-Vector AVP.

If the mobile node sets the home agent field equal to 0.0.0.0 in its Registration Request, the foreign agent sets the Home-Agent-Requested flag to one and zeroes the Home-Address-Allocatable-Only-in-Home-Realm flag in the MIP-Feature-Vector AVP.

Whenever the foreign agent sets either the Mobile-Node-Home-Address-Requested flag or the Home-Agent-Requested flag to one, it MUST set the MN-HA-Key-Request flag to one. The MN-HA-Key-Request flag is also set to one if the mobile node includes a "Generalized MN-HA Key Generation Nonce Request" [MIPKEYS] extension, with the subtype set to AAA.

If the mobile node includes a "Generalized MN-FA Key Generation Nonce Request" [MIPKEYS] extension with the AAA subtype (1) in its Registration Request, the foreign agent sets the MN-FA-Key-Request flag to one in the MIP-Feature-Vector AVP.

If the mobile node requests a home agent in the foreign network either by setting the home address field to all ones, or by specifying a home agent in the foreign network, and the AAAF authorizes the request, the AAAF MUST set the Home-Agent-In-Foreign-Network bit to one.

If the AAAF is willing and able to assign a home agent in the foreign network, the AAAF sets the Foreign-Home-Agent-Available flag to one.

If the Home Agent receives a Registration Request from the mobile node indicating that the MN is acting as a co-located mobile node, the home agent sets the Co-Located-Mobile-Node bit to one.

If the foreign agent's local policy allows it to receive AAA session keys and it does not have any existing FA-HA key with the home agent, the foreign agent MAY set the FA-HA-Key-Request flag.

The foreign agent MUST NOT set the Foreign-Home-Agent-Available and Home-Agent-In-Foreign-Network flag both to one.

When the AAAF receives the AMR message, it MUST first verify that the sender was an authorized foreign agent. The AAAF then takes any actions indicated by the settings of the MIP-Feature-Vector AVP flags. The AAAF then MAY set additional flags. Only the AAAF may set the Foreign-Home-Agent-Available and Home-Agent-In-Foreign-Network flags to one. This is done according to local administrative policy. When the AAAF has finished setting additional flags according to its local policy, then the AAAF transmits the AMR with the possibly modified MIP-Feature-Vector AVP to the AAAH.

7.6. MIP-MN-AAA-Auth AVP

The MN-AAA-Auth AVP (AVP Code 322) is of type Grouped and contains some ancillary data to simplify processing of the authentication data in the Mobile IPv4 Registration Request [MOBILEIP, MIPCHAL] by the target AAA server. Its value has the following ABNF grammar:

```
MIP-MN-AAA-Auth ::= < AVP Header: 322 >
                    { MIP-MN-AAA-SPI }
                    { MIP-Auth-Input-Data-Length }
                    { MIP-Authenticator-Length }
                    { MIP-Authenticator-Offset }
                    * [ AVP ]
```

7.6.1. MIP-MN-AAA-SPI AVP

The MIP-MN-AAA-SPI AVP (AVP Code 341) is of type Unsigned32 and indicates the MSA by which the targeted AAA server (AAA_H) should attempt to validate the Authenticator computed by the mobile node over the Registration Request data.

7.6.2. MIP-Auth-Input-Data-Length AVP

The MIP-Auth-Input-Data-Length AVP (AVP Code 338) is of type Unsigned32 and contains the length, in bytes, of the Registration Request data (data portion of MIP-Reg-Request AVP) that should be used as input to the algorithm, as indicated by the MN-AAA-SPI AVP, used to determine whether the Authenticator Data supplied by the mobile node is valid.

7.6.3. MIP-Authenticator-Length AVP

The MIP-Authenticator-Length AVP (AVP Code 339) is of type Unsigned32 and contains the length of the authenticator to be validated by the targeted AAA server (i.e., AAA_H).

7.6.4. MIP-Authenticator-Offset AVP

The MIP-Authenticator-Offset AVP (AVP Code 340) is of type Unsigned32 and contains the offset into the Registration Request Data, of the authenticator to be validated by the targeted AAA server (i.e., AAA_H).

7.7. MIP-FA-Challenge AVP

The MIP-FA-Challenge AVP (AVP Code 344) is of type OctetString and contains the challenge advertised by the foreign agent to the mobile node. This AVP MUST be present in the AMR if the mobile node used the RADIUS-style MN-AAA computation algorithm [MIPCHAL].

7.8. MIP-Filter-Rule AVP

The MIP-Filter-Rule AVP (AVP Code 342) is of type IPFilterRule and provides filter rules that have to be configured on the foreign or home agent for the user. The packet filtering rules are set by the AAAH by adding one or more MIP-Filter-Rule AVPs in the HAR if destined for the home agent and/or in the AMA if destined for the foreign agent.

7.9. MIP-Candidate-Home-Agent-Host

The MIP-Candidate-Home-Agent-Host AVP (AVP Code 336) is of type DiameterIdentity and contains the identity of a home agent in the foreign network that the AAAF proposes to be dynamically assigned to the mobile node.

7.10. MIP-Originating-Foreign-AAA AVP

The MIP-Originating-Foreign-AAA AVP (AVP Code 347) is of type Grouped and contains the identity of the AAAF, which issues the AMR to the AAAH. The MIP-Originating-Foreign-AAA AVP MUST only be used in cases when the home agent is or may be allocated in a foreign domain. If the MIP-Originating-Foreign-AAA AVP is present in the AMR, the AAAH MUST copy it into the HAR.

```
MIP-Originating-Foreign-AAA ::= < AVP Header: 347 >
                                { Origin-Realm }
                                { Origin-Host }
                                * [ AVP ]
```

7.11. MIP-Home-Agent-Host AVP

The MIP-Home-Agent-Host AVP (AVP Code 348) is of type Grouped and contains the identity of the assigned Home Agent. If the MIP-Home-Agent-Host AVP is present in the AMR, the AAAH MUST copy it into the HAR.

```
MIP-Home-Agent-Host ::= < AVP Header: 348 >
                        { Destination-Realm }
                        { Destination-Host }
                        * [ AVP ]
```

8. Key Distribution

The mobile node and mobility agents use session keys (i.e., the MN-FA, FA-HA, and MN-HA session keys) to compute authentication extensions applied to MIP registration messages, as defined in [MOBILEIP]. If session keys are requested, the AAAH MUST return the keys and nonces after the mobile node is successfully authenticated and authorized.

The SPI values are used as key identifiers, and each session key has its own SPI value; nodes that share a key can have multiple different SPIs all referring to the same key. In all cases, the entity that receives an authentication extension (i.e., that verifies the authentication extension) is providing the entity that sends the authentication extension (i.e., that computes the authentication extension) the value of the SPI to use for that computation. Note that the keys in this model are symmetric in that they are used in both directions, even though the SPIs do not have to be symmetric.

The mobile node allocates SPIs for use in the FA-MN and HA-MN mobility security associations, via the Mobile IPv4 AAA Key Request extensions [MIPKEYS]. The home agent allocates SPIs for the MN-HA and FA-HA mobility security association. The foreign agent chooses SPIs for the MN-FA and HA-FA mobility security associations.

Once the session keys and nonces have been distributed, subsequent Mobile IPv4 registrations need not invoke the AAA infrastructure until the keys expire. As mandated by Mobile IPv4, these registrations MUST include the MN-HA authentication extension. Likewise, subsequent registrations MUST also include MN-FA authentication extension if the MN-FA session key was generated and distributed by AAA. The same hold true for subsequent use of the FA-HA authentication extensions.

8.1. Authorization Lifetime vs. MIP Key Lifetime

The Diameter Mobile IPv4 application makes use of two timers: the Authorization-Lifetime AVP [DIAMBASE] and the MIP-MSA-Lifetime AVP.

The Authorization-Lifetime contains the number of seconds before the mobile node must issue a subsequent MIP registration request. The content of the Authorization-Lifetime AVP corresponds to the Lifetime field in the MIP header [MOBILEIP].

The MIP-MSA-Lifetime AVP contains the number of seconds before session keys destined for the mobility agents and the mobile node expire. A value of zero indicates infinity (no timeout). If not

zero, the value of the MIP-MSA-Lifetime AVP MUST be at least equal to the value in the Authorization Lifetime AVP.

8.2. Nonce vs. Session Key

As described in section 3.4, the AAAH generates session keys and transmits them to the home agent and foreign agent. The AAAH generates nonces that correspond to the same keys and transmits them to the mobile node. When it is necessary to protect the session keys and SPIs from un-trusted Diameter agents, end-to-end security mechanisms such as TLS or IPSec are required to eliminate all Diameter Agents between the FA or HA and the AAAH, as outlined above.

In [MIPKEYS], the mobility security associations are established via nonces transmitted to the mobile node via Mobile IPv4. To provide the nonces, the AAAH must generate a random [RANDOM] value of at least 128 bits [MIPKEYS]. The mobile node then uses the nonce to derive the MN-HA and MN-FA session keys.

More details of the MN-HA and the MN-FA session key creation procedures are found in [MIPKEYS].

The hashing algorithm used by the mobile node to construct the session key has to be the same as that used by the AAAH in the session key generation procedure. The AAAH therefore indicates the algorithm used along with the nonce.

The FA-HA and HA-FA session key is shared between the FA and HA. The AAAH generates a random [RANDOM] value of at least 128 bits for use as this session key.

See sections 9 for details about the format of the AVPs used to transport the session keys.

8.3. Distributing the Mobile-Home Session Key

If the mobile node does not have an MN-HA session key, then the AAAH is likely to be the only trusted entity that is available to the mobile node. Thus, the AAAH has to generate the MN-HA session key.

The distribution of the HA-MN (session) key to the HA is specified in sections 1.2 and 3.4. The HA and AAAH establish a security association (IPSec or TLS) and transport the key over it. If no security association exists between the AAAH and the home agent and a security association cannot be established, the AAAH MUST return a Result-Code AVP with DIAMETER_ERROR_END_TO_END_MIP_KEY_ENCRYPTION.

The AAAH also has to arrange for the key to be delivered to the mobile node. Unfortunately, the AAAH only knows about Diameter messages and AVPs, and the mobile node only knows about Mobile IPv4 messages and extensions [MOBILEIP]. For this purpose, AAAH includes the MN-HA MIP-nonce AVP into a MIP-MN-to-HA-MSA AVP, which is added to the HAR (for FA COA style Mobile IPv4) or to the AMA (for collocated COA-style Mobile IPv4 messages) and delivered either to a local home agent or a home agent in the visited network. Note that the mobile node will use the nonce to create the MN-HA session key by using the MN-AAA key it shares with the AAAH [MIPKEYS]. The AAAH has to rely on the home agent (which also understands Diameter) to transfer the nonce into a Mobile IPv4 "Generalized MN-HA Key Generation Nonce Reply" extension [MIPKEYS] in the Registration Reply message. The HA includes the SPIs proposed by the mobile node and the home agent in the "Generalized MN-HA Key Generation Nonce Request" extension. The home agent can format the Reply message and extensions correctly for eventual delivery to the mobile node. The resulting Registration Reply is added to the HAA's MIP-Reg-Reply AVP.

The AAAH parses the HAA message, transforms it into an AMA message containing an MIP-Reg-Reply AVP, and sends the AMA message to the foreign agent. The foreign agent then uses that AVP to recreate a Registration Reply message containing the "Generalized MN-HA Key Generation Nonce Reply" extension for delivery to the mobile node.

In summary, the AAAH generates the MN-HA nonce, which is added to the MIP-MN-to-HA-MSA AVP, and a session key, which is added to the MIP-HA-to-MN-MSA AVP. These AVPs are delivered to the home agent in HAR or AMA messages. The home agent retains the session key for its own use and copies the nonce from the MIP-MN-to-HA-MSA AVP into a "Generalized MN-HA Key Generation Nonce Reply" extension, which is appended to the Mobile IPv4 Registration Reply message. This Registration Reply message MUST also include the HA-MN authentication extension, which is created by using the newly allocated HA-MN session key. The home agent then includes the Registration Reply message and extensions into a MIP-Reg-Reply AVP as part of the HAA message to be sent back to the AAA server.

The key derived by the MN from the MN-HA session nonce is identical to the HA-MN session key provided to the HA.

8.4. Distributing the Mobile-Foreign Session Key

The MN-FA session nonce is also generated by AAAH (upon request) and added to the MIP-MN-to-FA-MSA AVP, which is added to the HAR and copied by the home agent into a "Generalized MN-FA Key Generation Nonce Reply" extension [MIPKEYS] of the Mobile IPv4 Registration Reply message. The HA also includes the SPIs proposed by the mobile

node and foreign agent in the "Generalized MN-FA Key Generation Nonce Request" extension. The AAAH includes the FA-MN session key in the MIP-FA-to-MN-MSA AVP in the AMA, to be used by the foreign agent in the computation of the FA-MN authentication extension.

The key derived by the MN from the MN-FA session nonce is identical to the FA-MN session key provided to the FA.

8.5. Distributing the Foreign-Home Session Key

If the foreign agent requests an FA-HA session key, it also includes a MIP-HA-to-FA-SPI AVP in the AMR to convey the SPI to be used by the home agent for this purpose. The AAAH generates the FA-HA session key, which is identical to the HA-FA session key, and distributes that to both the HA and the FA over respective security associations by using the MIP-HA-to-FA-MSA and MIP-FA-to-HA-MSA AVPs. The HA conveys the SPI that the FA MUST use in the HAA; this is similar to the way in which the FA conveys that the SPI that the HA MUST use in the AMR. The AAAH later includes these SPIs in the MIP-FA-HA-MSA and MIP-HA-FA-MSA AVPs, respectively, along with the session key.

Refer to Figures 2, 3, 4, and 6 for the messages involved.

Note that if multiple MNs are registered on the same FA and HA pair, then multiple mobility security associations would be distributed. However, only one is required to protect the Mobile IP control traffic between FA and HA. This creates an unacceptable level of state (i.e., to store the two SPIs and shared key for each FA-HA mobility security association). To improve scalability, the FA and HA may discard FA-HA mobility security associations prior to the time when they actually expire. However, if a proper discard policy is not chosen, this could cause Mobile IP messages in transit or waiting in queues for transmission to fail authentication.

The FA MUST always use the FA-HA security association with the latest expiry time when computing authentication extensions on outgoing messages. The FA MAY discard HA-FA mobility security associations 10 seconds after a new HA-FA mobility security association arrives with a later expiry time.

The HA SHOULD use the HA-FA mobility security association that has the latest expiry time when computing authentication extensions in outgoing messages. However, when the HA receives a new HA-FA mobility security association with a later expiry time, the HA SHOULD wait 4 seconds for the AMA to propagate to the FA before using the new association. Note that the HA always uses the mobility security association from the HAR when constructing the Mobile IP Registration Reply in the corresponding HAA. The HA MAY discard an FA-HA mobility

security association once it receives a message authenticated by a FA-HA mobility security association with a later expiry time.

9. Key Distribution AVPs

The Mobile-IP protocol defines a set of mobility security associations shared between the mobile node, foreign agent, and home agent. These three mobility security associations (MN-HA, MN-FA, and FA-HA) are dynamically created by the AAAH and have previously been described in sections 3.4 and 8. AAA servers supporting the Diameter Mobile IP Application MUST implement the key distribution AVPs defined in this document.

The names of the key distribution AVPs indicate the two entities sharing the mobility security association. The first named entity in the AVP name will use the mobility security association to create authentication extensions using the given SPI and key. The second named entity in the AVP name will use the mobility security association to verify the authentication extensions of received Mobile IP messages.

For instance, the MIP-MN-to-HA-MSA AVP contains the MN-HA nonce, which the mobile node will use to derive the MN-HA Key, and the MIP-HA-to-MN-MSA AVP contains the MN-HA key for the home agent. Note that mobility security associations are unidirectional; however, this application delivers only one key that is shared between both unidirectional security associations that exist between two peers. The security considerations of using the same key in each direction are given in section 13. The SPIs are, however, unique to each unidirectional security association and are chosen by the peer that will receive the Mobile IP messages authenticated with that security association.

The following table describes the Diameter AVPs defined in the Mobile IP application and their AVP Code values, types, and possible flag values.

Attribute Name	AVP Code	Section Defined	Value Type	AVP Flag Rules				
				MUST	MAY	SHLD NOT	MUST NOT	MAY Encr
MIP-FA-to-HA-SPI	318	9.11	Unsigned32	M	P		V	Y
MIP-FA-to-MN-SPI	319	9.10	Unsigned32	M	P		V	Y
MIP-HA-to-FA-SPI	323	9.14	Unsigned32	M	P		V	Y
MIP-MN-to-FA-MSA	325	9.5	Grouped	M	P		V	Y
MIP-FA-to-MN-MSA	326	9.1	Grouped	M	P		V	Y
MIP-FA-to-HA-MSA	328	9.2	Grouped	M	P		V	Y
MIP-HA-to-FA-MSA	329	9.3	Grouped	M	P		V	Y
MIP-MN-to-HA-MSA	331	9.6	Grouped	M	P		V	Y
MIP-HA-to-MN-MSA	332	9.4	Grouped	M	P		V	Y
MIP-Nonce	335	9.12	OctetString	M	P		V	Y
MIP-Session-Key	343	9.7	OctetString	M	P		V	Y
MIP-Algorithm-Type	345	9.8	Enumerated	M	P		V	Y
MIP-Replay-Mode	346	9.9	Enumerated	M	P		V	Y
MIP-MSA-Lifetime	367	9.13	Unsigned32	M	P		V	Y

9.1. MIP-FA-to-MN-MSA AVP

The MIP-FA-to-MN-MSA AVP (AVP Code 326) is of type Grouped and contains the FA-MN session key. This AVP is conveyed to the FA in an AMA message. The MN allocates the MIP-FA-to-MN-SPI. The FA creates an FA-MN authentication extension by using the session key and algorithm, and the MN verifies that extension by using the same session key and algorithm. The data field of this AVP has the following ABNF grammar:

```

MIP-FA-to-MN-MSA ::= < AVP Header: 326 >
                    { MIP-FA-to-MN-SPI }
                    { MIP-Algorithm-Type }
                    { MIP-Session-Key }
                    * [ AVP ]
    
```

9.2. MIP-FA-to-HA-MSA AVP

The MIP-FA-to-HA-MSA AVP (AVP Code 328) is of type Grouped and contains the FA-HA session key. This AVP is conveyed to the FA in an AMA message. The HA allocates the MIP-FA-to-HA-SPI. The FA creates the FA-HA authentication extension by using the session key and algorithm, and the HA verifies that extension by using the same key and algorithm. The AVP's data field has the following ABNF grammar:

```

MIP-FA-to-HA-MSA ::= < AVP Header: 328 >
                    { MIP-FA-to-HA-SPI }
                    { MIP-Algorithm-Type }
                    { MIP-Session-Key }
                    * [ AVP ]

```

9.3. MIP-HA-to-FA-MSA AVP

The MIP-HA-to-FA-MSA AVP (AVP Code 329) is of type Grouped and contains the Home Agent's session key, which it shares with the foreign agent. This AVP is conveyed to the HA in an HAR message. The FA allocates the MIP-HA-to-FA-SPI. The HA creates the HA-FA authentication extension by using the session key and algorithm, and the FA verifies that extension by using the same session key and algorithm. The AVP's data field has the following ABNF grammar:

```

MIP-HA-to-FA-MSA ::= < AVP Header: 329 >
                    { MIP-HA-to-FA-SPI }
                    { MIP-Algorithm-Type }
                    { MIP-Session-Key }
                    * [ AVP ]

```

9.4. MIP-HA-to-MN-MSA AVP

The MIP-HA-to-MN-MSA AVP (AVP Code 332) is of type Grouped, and contains the HA-MN session key. This AVP is conveyed to the HA in an HAR for FA COA Mobile IPv4 and in an AMA for collocated COA Mobile IPv4. The MN allocates the MIP-HA-to-MN-SPI. The HA creates the HA-MN authentication extension by using the session key and algorithm, and the MN verifies that extension by using the same key and algorithm. The AVP's field has the following ABNF grammar:

```

MIP-HA-to-MN-MSA ::= < AVP Header: 332 >
                    { MIP-HA-to-MN-SPI }
                    { MIP-Algorithm-Type }
                    { MIP-Replay-Mode }
                    { MIP-Session-Key }
                    * [ AVP ]

```

9.5. MIP-MN-to-FA-MSA AVP

The MIP-MN-to-FA-MSA AVP (AVP Code 325) is of type Grouped, and contains the MN-FA session nonce, which the mobile node uses to derive the MN-FA session key. This AVP is conveyed to the HA in an HAR message. The FA allocates the MIP-MN-to-FA-SPI. The MN creates the MN-FA authentication extension by using the session key and algorithm, and the FA verifies that extension using the same key and algorithm.

The home agent uses this AVP in the construction of the Mobile IP "Generalized MN-FA Key Generation Nonce Reply" extension [MIPKEYS].

```
MIP-MN-to-FA-MSA ::= < AVP Header: 325 >
                    { MIP-MN-FA-SPI }
                    { MIP-Algorithm-Type }
                    { MIP-nonce }
                    * [ AVP ]
```

9.6. MIP-MN-to-HA-MSA AVP

The MIP-MN-to-HA-MSA AVP (AVP Code 331) is of type Grouped and contains the MN-HA session nonce, which the mobile node uses to derive the MN-HA session key. This AVP is conveyed to the HA in an HAR message for FA COA Mobile IPv4 and in an AMR for collocated Mobile IPv4. The HA allocates the MIP-MN-to-HA-SPI. The MN creates the MN-FA authentication extension using the session key and algorithm, and the HA verifies that extension using the same session key and algorithm.

The Home Agent uses this AVP in the construction of the Mobile IP "Generalized MN-HA Key Generation Nonce Reply" extension [MIPKEYS].

```
MIP-MN-to-HA-MSA ::= < AVP Header: 331 >
                    { MIP-MN-HA-SPI }
                    { MIP-Algorithm-Type }
                    { MIP-Replay-Mode }
                    { MIP-nonce }
                    * [ AVP ]
```

9.7. MIP-Session-Key AVP

The MIP-Session-Key AVP (AVP Code 343) is of type OctetString and contains the Session Key for the associated Mobile IPv4 authentication extension. The HAAA selects the session key.

9.8. MIP-Algorithm-Type AVP

The MIP-Algorithm-Type AVP (AVP Code 345) is of type Enumerated and contains the Algorithm identifier for the associated Mobile IPv4 authentication extension. The HAAA selects the algorithm type. The following values are currently defined:

```
2   HMAC-SHA-1 [HMAC]
```

9.9. MIP-Replay-Mode AVP

The MIP-Replay-Mode AVP (AVP Code 346) is of type Enumerated and contains the replay mode the Home Agent for authenticating the mobile node. The HAAA selects the replay mode.

The following values are supported (see [MOBILEIP] for more information):

- 1 None
- 2 Timestamps
- 3 Nonces

9.10. MIP-FA-to-MN-SPI AVP

The MIP-FA-to-MN-SPI AVP (AVP Code 319) is of type Unsigned32, and it contains the Security Parameter Index the FA that and MN use to refer to the FA-MN mobility security association. The MN allocates the SPI, and it MUST NOT have a value between zero (0) and 255, which is the reserved namespace defined in [MOBILEIP].

9.11. MIP-FA-to-HA-SPI AVP

The MIP-FA-to-HA-SPI AVP (AVP Code 318) is of type Unsigned32 and contains the Security Parameter Index the FA and HA use to refer to the FA-HA mobility security association. The HA allocates the SPI, and it MUST NOT have a value between zero (0) and 255, which is the reserved namespace defined in [MOBILEIP].

9.12. MIP-Nonce AVP

The MIP-Nonce AVP (AVP Code 335) is of type OctetString and contains the nonce sent to the mobile node for the associated authentication extension. The mobile node follows the procedures in [MIPKEYS] to generate the session key used to authenticate Mobile IPv4 registration messages. The HAAA selects the nonce.

9.13. MIP-MSA-Lifetime AVP

The MIP-MSA-Lifetime AVP (AVP Code 367) is of type Unsigned32 and represents the period of time (in seconds) for which the session key or nonce is valid. The associated session key or nonce, as the case may be, MUST NOT be used if the lifetime has expired; if the session key or nonce lifetime expires while the session to which it applies is still active, either the session key or nonce MUST be changed or the association Mobile IPv4 session MUST be terminated.

9.14. MIP-HA-to-FA-SPI AVP

The MIP-HA-to-FA-SPI AVP (AVP Code 323) is of type Unsigned32 and contains the Security Parameter Index the HA and FA use to refer to the HA-FA mobility security association. The FA allocates the SPI, and it MUST NOT have a value between zero (0) and 255, which is the reserved namespace defined in [MOBILEIP].

10. Accounting AVPs

10.1. Accounting-Input-Octets AVP

The Accounting-Input-Octets AVP (AVP Code 363) is of type Unsigned64, and contains the number of octets in IP packets received from the user. This AVP MUST be included in all Accounting-Request messages and MAY be present in the corresponding Accounting-Answer messages as well.

10.2. Accounting-Output-Octets AVP

The Accounting-Output-Octets AVP (AVP Code 364) is of type Unsigned64 and contains the number of octets in IP packets sent to the user. This AVP MUST be included in all Accounting-Request messages and MAY be present in the corresponding Accounting-Answer messages as well.

10.3. Acct-Session-Time AVP

The Acct-Time AVP (AVP Code 46) is of type Unsigned32 and indicates the length of the current session in seconds. This AVP MUST be included in all Accounting-Request messages and MAY be present in the corresponding Accounting-Answer messages as well.

10.4. Accounting-Input-Packets AVP

The Accounting-Input-Packets (AVP Code 365) is of type Unsigned64 and contains the number of IP packets received from the user. This AVP MUST be included in all Accounting-Request messages and MAY be present in the corresponding Accounting-Answer messages as well.

10.5. Accounting-Output-Packets AVP

The Accounting-Output-Packets (AVP Code 366) is of type Unsigned64 and contains the number of IP packets sent to the user. This AVP MUST be included in all Accounting-Request messages and MAY be present in the corresponding Accounting-Answer messages as well.

10.6. Event-Timestamp AVP

The Event-Timestamp (AVP Code 55) is of type Time and MAY be included in an Accounting-Request message to record the time at which this event occurred on the mobility agent, in seconds since January 1, 1970, 00:00 UTC.

11. AVP Occurrence Tables

The following tables present the AVPs defined in this document and their occurrences in Diameter messages. Note that AVPs that can only be present within a Grouped AVP are not represented in this table.

The table uses the following symbols:

- 0 The AVP MUST NOT be present in the message.
- 0+ Zero or more instances of the AVP MAY be present in the message.
- 0 - 1 Zero or one instance of the AVP MAY be present in the message.
- 1 One instance of the AVP MUST be present in the message.

11.1. Mobile IP Command AVP Table

The table in this section is limited to the Command Codes defined in this specification.

Attribute Name	Command-Code			
	AMR	AMA	HAR	HAA
Authorization-Lifetime	0-1	0-1	1	0
Auth-Application-Id	1	1	1	1
Auth-Session-State	0-1	0-1	1	0
Acct-Multi-Session-Id	0-1	0-1	0	0-1
Destination-Host	0-1	0	0-1	0
Destination-Realm	1	0	1	0
Error-Message	0	0-1	0	0-1
Error-Reporting-Host	0	0-1	0	0-1
MIP-Candidate-Home-Agent-Host	0-1	0	0-1	0
MIP-Home-Agent-Host	0-1	0	0-1	0
MIP-Originating-Foreign-AAA	0-1	0	0-1	0
MIP-FA-Challenge	0-1	0	0	0
MIP-FA-to-MN-MSA	0	0-1	0	0
MIP-FA-to-HA-MSA	0	0-1	0	0
MIP-HA-to-FA-MSA	0	0	0-1	0
MIP-HA-to-MN-MSA	0	0-1	0-1	0

MIP-MN-to-FA-MSA	0	0	0-1	0
MIP-MN-to-HA-MSA	0	0-1	0-1	0
MIP-FA-to-HA-SPI	0	0	0	0-1
MIP-HA-to-FA-SPI	0	0	0	0-1
MIP-FA-to-MN-SPI	0	0	0	0-1
MIP-MN-to-FA-SPI	0	0	0	0-1
MIP-HA-to-MN-SPI	0	0	0	0-1
MIP-MN-to-HA-SPI	0	0	0	0-1
MIP-Feature-Vector	0-1	0-1	1	0
MIP-Filter-Rule	0	0+	0+	0
MIP-Home-Agent-Address	0-1	0-1	0-1	0-1
MIP-MSA-Lifetime	0	0-1	0-1	0
MIP-MN-AAA-Auth	1	0	0	0
MIP-Mobile-Node-Address	0-1	0-1	0-1	0-1
MIP-Reg-Reply	0	0-1	0	0-1
MIP-Reg-Request	1	0	1	0
Origin-Host	1	1	1	1
Origin-Realm	1	1	1	1
Origin-State-Id	0-1	0-1	0-1	0-1
Proxy-Info	0+	0+	0+	0+
Redirect-Host	0	0+	0	0+
Redirect-Host-Usage	0	0-1	0	0-1
Redirect-Max-Cache-Time	0	0-1	0	0-1
Result-Code	0	1	0	1
Re-Auth-Request-Type	0	0-1	0	0
Route-Record	0+	0	0+	0
Session-Id	1	1	1	1
User-Name	1	0-1	1	0-1
-----	-----	-----	-----	-----

11.2. Accounting AVP Table

The table in this section is used to represent which AVPs defined in this document are to be present in the Accounting messages, as defined in [DIAMBASE].

Attribute Name	Command-Code	
	ACR	ACA
Accounting-Input-Octets	1	0-1
Accounting-Input-Packets	1	0-1
Accounting-Output-Octets	1	0-1
Accounting-Output-Packets	1	0-1
Acct-Multi-Session-Id	1	0-1
Acct-Session-Time	1	0-1
MIP-Feature-Vector	1	0-1
MIP-Home-Agent-Address	1	0-1
MIP-Mobile-Node-Address	1	0-1
Event-Timestamp	0-1	0

12. IANA Considerations

This section contains the namespaces that have either been created in this specification or had their values assigned to existing namespaces managed by IANA.

12.1. Command Codes

This specification assigns the values 260 and 262 from the Command Code namespace defined in [DIAMBASE]. See section 5 for the assignment of the namespace in this specification.

12.2. AVP Codes

This specification assigns the values 318 - 348 and 363 - 367 from the AVP Code namespace defined in [DIAMBASE]. See sections 7, 9, and 10 for the assignment of the namespace in this specification.

12.3. Result-Code AVP Values

This specification assigns the values 4005 - 4008 and 5024 - 5025 from the Result-Code AVP (AVP Code 268) value namespace defined in [DIAMBASE]. See section 6 for the assignment of the namespace in this specification.

12.4. MIP-Feature-Vector AVP Values

There are 32 bits in the MIP-Feature-Vector AVP (AVP Code 337) that are available for assignment. This document assigns bits 1 - 9, as listed in section 7.5. The remaining bits should only be assigned via Standards Action [IANA].

12.5. MIP-Algorithm-Type AVP Values

As defined in section 9.8, the MIP-Algorithm-Type AVP (AVP Code 345) defines the value 2. All remaining values, except zero, are available for assignment via Designated Expert [IANA].

12.6. MIP-Replay-Mode AVP Values

As defined in section 9.9, the MIP-Replay-Mode AVP (AVP Code 346) defines the values 1 - 3. All remaining values, except zero, are available for assignment via Designated Expert [IANA].

12.7. Application Identifier

This specification uses the value two (2) to the Application Identifier namespace defined in [DIAMBASE]. See section 4 for more information.

13. Security Considerations

This specification describes a Mobile IPv4 Diameter Application for authenticating and authorizing a Mobile IPv4 mobile node. The authentication algorithm used is dependent on the transforms used within the Mobile IPv4 protocol, and [MIPCHAL]. This specification, in conjunction with [MIPKEYS], also defines a method by which the home Diameter server can create and distribute session keys and nonces for use in authenticating and integrity-protecting Mobile IPv4 registration messages [MOBILEIP]. The key distribution is asymmetric, as communication with the mobile node occurs via the Mobile IPv4 protocol [MIPKEYS, MOBILEIP], where as communication to the Home Agent and Foreign Agent occurs via the Diameter protocol. Where untrusted Diameter agents are present, end-to-end security MUST be used. The end-to-end security takes the form of TLS or IPsec security associations between the AAAH and the FA and between the AAAH and the HA. These connections will be authenticated with the use of public keys and certificates; however, the identities that appear in the certificates must be authorized and bound to a particular Mobile IPv4 Diameter session before the AAAH can safely begin distribution of keys.

Note that the direct connections are established as a result of Diameter redirect messages. For example, in Figure 3, the FA gets a redirect response containing the Redirect-Host AVP of the AAAH. This is the identity that should be matched against the certificate presented by the AAAH when the secure connection is established. In this case, the network of Diameter proxies and redirect agents is trusted with the task of returning the correct AAAH identity to the FA.

The AAAH must also make an authorization decision when the FA establishes the connection. If the AAAH and the redirect server are one and the same, then the AAAH may have observed and noted the original AMR message that contained the identity of the FA and so may authorize the establishment of a TLS or IPsec connection from the same entity. Otherwise, the AAAH would need to maintain a list of all authorized visited domains (roaming partners) and authorize TLS or IPsec connections based on this list. Note that establishment of the connection is only the first step, and the AAAH has another opportunity to deny service upon receipt of the AMR message itself. At this step, the AAAH can check the internal AVPs of the AMR to ensure that the FA is valid; for example, it can check that the Mobile IP COA is equal to the IP address used as the endpoint of the TLS or IPsec connection. However, such a policy would prevent the FA from using different interfaces for AAA and Mobile IP tunnel packets and may not be desirable in every deployment situation.

A similar set of considerations applies to the connection between AAAH and HA when those entities are in different administrative domains. However, here the roles are reversed because it is the AAAH that contacts the HA via the HAR. The identity of the candidate HA is given to the AAAH in the AMR, and the AAAH should expect to receive the same identity in the public key certificates during TLS or IPsec negotiation. The HA may authorize individual connections by acting as its own redirect server, or it may maintain a list of trusted roaming partners.

This application creates and distributes a single session key for each pair of MSAs between two entities; e.g., the same session key is used for the MN-HA MSA and the HA-MN MSA. This is safe to do from a security perspective, as the session keys are only used with keyed hash functions to generate authenticator values that protect the integrity of each Mobile IP control message. Mobile IP messages have built-in replay protection with the use of timestamps or nonces [MOBILEIP], and, due to the nature of the protocol, requests are always different bitwise from responses, at least in the message type code. This avoids problems that might arise in other situations

where an attacker could mount a replay or reflection attack if the same key were used (for example) to encrypt otherwise unprotected traffic on more than one connection leg in the network.

Nonces are sent to the mobile node, which are used to generate the session keys via the HMAC-SHA-1 one-way function. Because the nonces and authentication extensions may be observed by anyone with access to a clear-text copy of the Registration Reply, the pre-shared key between the mobile node and the home Diameter server would be vulnerable to an offline dictionary attack if it did not contain enough entropy. To prevent this, the pre-shared key between the mobile node and the home Diameter server SHOULD be a randomly chosen quantity of at least 96 bits.

Because the session key is determined by the long-term secret and the nonce, the nonce SHOULD be temporally and globally unique; if the nonce were to repeat, then so would the session key. To prevent this, a nonce is strongly recommended to be a random [RANDOM] value of at least 128 bits. The long-term secret between the MN and AAAH MUST be refreshed periodically, to guard against recovery of the long-term secret due to nonce reuse or other factors. This is accomplished by using out-of-band mechanisms, which are not specified in this document.

Note that it is not recommended to set the MIP-MSA-Lifetime AVP value to zero, as keeping session keys for a long time (no refresh) increases the level of vulnerability.

14. References

14.1. Normative References

- [ABNF] Crocker, D. and P. Overell, "Augmented BNF for Syntax Specifications: ABNF", RFC 2234, November 1997.
- [DIAMBASE] Calhoun, P., Loughney, J., Guttman, E., Zorn, G., and J. Arkko, "Diameter Base Protocol", RFC 3588, September 2003.
- [IANA] Narten, T. and H. Alvestrand, "Guidelines for Writing an IANA Considerations Section in RFCs", BCP 26, RFC 2434, October 1998.
- [MOBILEIP] Perkins, C., "IP Mobility Support for IPv4", RFC 3344, August 2002.

- [MIPCHAL] Perkins, C. and P. Calhoun, "Mobile IPv4 Challenge/Response Extensions", RFC 3012, November 2000.
- [NAI] Aboba, B. and M. Beadles, "The Network Access Identifier", RFC 2486, January 1999.
- [HMAC] Krawczyk, H., Bellare, M., and R. Canetti, "HMAC: Keyed-Hashing for Message Authentication", RFC 2104, February 1997.
- [MIPKEYS] Perkins, C. and P. Calhoun, "Authentication, Authorization, and Accounting (AAA) Registration Keys for Mobile IP", RFC 3957, March 2005.
- [AAANAI] Johansson, F. and T. Johansson, "Mobile IPv4 Extension for Carrying Network Access Identifiers", RFC 3846, June 2004.
- [IPSEC] Kent, S. and R. Atkinson, "Security Architecture for the Internet Protocol", RFC 2401, November 1998.
- [TLS] Blake-Wilson, S., Nystrom, M., Hopwood, D., Mikkelsen, J., and T. Wright, "Transport Layer Security (TLS) Extensions", RFC 3546, June 2003.
- [KEYWORDS] Bradner, S., "Key words for use in RFCs to Indicate Requirement Levels", BCP 14, RFC 2119, March 1997.

14.2. Informative References

- [MIPREQ] Glass, S., Hiller, T., Jacobs, S., and C. Perkins, "Mobile IP Authentication, Authorization, and Accounting Requirements", RFC 2977, October 2000.
- [CDMA2000] Hiller, T., Walsh, P., Chen, X., Munson, M., Dommety, G., Sivalingham, S., Lim, B., McCann, P., Shiino, H., Hirschman, B., Manning, S., Hsu, R., Koo, H., Lipford, M., Calhoun, P., Lo, C., Jaques, E., Campbell, E., Xu, Y., Baba, S., Ayaki, T., Seki, T., and A. Hameed, "CDMA2000 Wireless Data Requirements for AAA", RFC 3141, June 2001.
- [EVALROAM] Aboba, B. and G. Zorn, "Criteria for Evaluating Roaming Protocols", RFC 2477, January 1999.
- [MIPNAI] Calhoun, P. and C. Perkins, "Mobile IP Network Access Identifier Extension for IPv4", RFC 2794, March 2000.

[RANDOM] Eastlake, D., 3rd, Schiller, J., and S. Crocker,
"Randomness Requirements for Security", BCP 106, RFC
4086, June 2005.

15. Acknowledgements

The authors would like to thank Nenad Trifunovic, Haseeb Akhtar, and Pankaj Patel for their participation in the pre-IETF Document Reading Party; Erik Guttman for his very useful proposed text; and to Fredrik Johansson, Martin Julien, and Bob Kopacz for their very useful contributed text.

The authors would also like to thank the participants of 3GPP2's TSG-X working group for their valuable feedback, and the following people for their contribution in the development of the protocol: Kevin Purser, Thomas Panagiotis, Mark Eklund, Paul Funk, Michael Chen, Henry Haverinen, and Johan Johansson. General redirect server text due to Pasi Eronen was borrowed from Diameter-EAP.

Pat Calhoun would like to thank Sun Microsystems, as most of the effort put into this document was done while he was in their employ.

Authors' Addresses

Questions about this memo can be directed to:

Pat Calhoun
Cisco Systems, Inc.
170 West Tasman Drive
San Jose, CA 95134
USA

Phone: +1 408-853-5269
EMail: pcalhoun@cisco.com

Tony Johansson
Bytemobile, Inc.
2029 Stierlin Court
Mountain View, CA 94043

Phone: +1 650-641-7817
Fax: +1 650-641-7701
EMail: tony.johansson@bytemobile.com

Charles E. Perkins
Nokia Research Center
313 Fairchild Drive
Mountain View, CA 94043
USA

Phone: +1 650-625-2986
Fax: +1 650-625-2502
EMail: Charles.Perkins@nokia.com

Tom Hiller
Lucent Technologies
1960 Lucent Lane
Naperville, IL 60566
USA

Phone: +1 630-979-7673
EMail: tomhiller@lucent.com

Peter J. McCann
Lucent Technologies
1960 Lucent Lane
Naperville, IL 60563
USA

Phone: +1 630-713-9359
Fax: +1 630-713-1921
EMail: mccap@lucent.com

Full Copyright Statement

Copyright (C) The Internet Society (2005).

This document is subject to the rights, licenses and restrictions contained in BCP 78, and except as set forth therein, the authors retain all their rights.

This document and the information contained herein are provided on an "AS IS" basis and THE CONTRIBUTOR, THE ORGANIZATION HE/SHE REPRESENTS OR IS SPONSORED BY (IF ANY), THE INTERNET SOCIETY AND THE INTERNET ENGINEERING TASK FORCE DISCLAIM ALL WARRANTIES, EXPRESS OR IMPLIED, INCLUDING BUT NOT LIMITED TO ANY WARRANTY THAT THE USE OF THE INFORMATION HEREIN WILL NOT INFRINGE ANY RIGHTS OR ANY IMPLIED WARRANTIES OF MERCHANTABILITY OR FITNESS FOR A PARTICULAR PURPOSE.

Intellectual Property

The IETF takes no position regarding the validity or scope of any Intellectual Property Rights or other rights that might be claimed to pertain to the implementation or use of the technology described in this document or the extent to which any license under such rights might or might not be available; nor does it represent that it has made any independent effort to identify any such rights. Information on the procedures with respect to rights in RFC documents can be found in BCP 78 and BCP 79.

Copies of IPR disclosures made to the IETF Secretariat and any assurances of licenses to be made available, or the result of an attempt made to obtain a general license or permission for the use of such proprietary rights by implementers or users of this specification can be obtained from the IETF on-line IPR repository at <http://www.ietf.org/ipr>.

The IETF invites any interested party to bring to its attention any copyrights, patents or patent applications, or other proprietary rights that may cover technology that may be required to implement this standard. Please address the information to the IETF at ietf-ipr@ietf.org.

Acknowledgement

Funding for the RFC Editor function is currently provided by the Internet Society.